

NEUHEITEN | NEWS

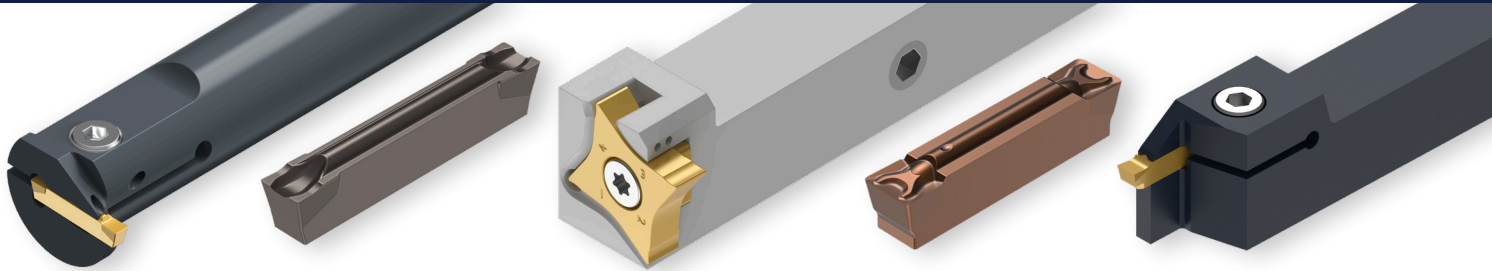

CARBO SX2

HARD SX3

MULTICUT 4 | EXTENDED

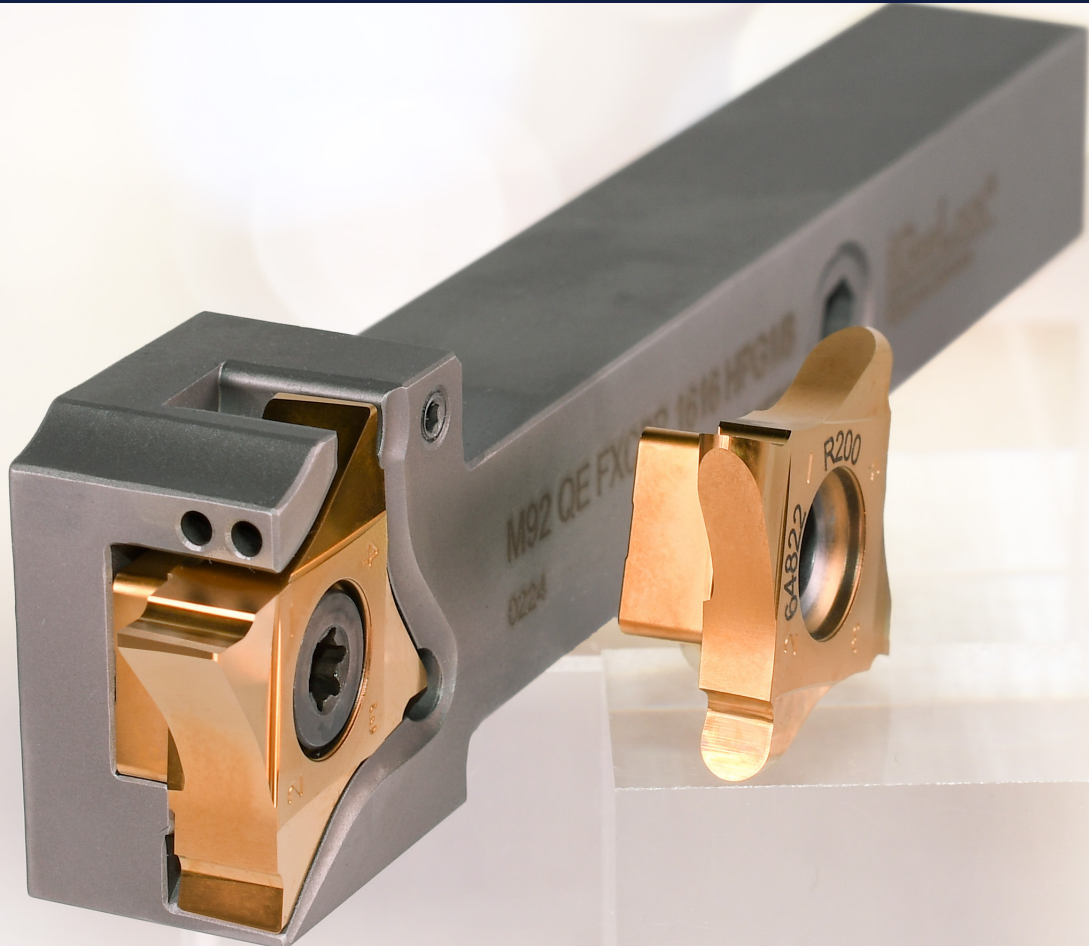

Made in Germany

MULTICUT 4 - EXTENDED Bis Stechbreite 6,5 mm | *up to 6,5 mm width* **4 Schneiden** | *4 edges*

Platten für Präzi-, Radiusform- und Axialeinstiche + SONDER

Inserts for precision-, radiusform- and face grooving + special applications

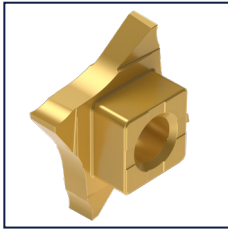

OFQE R/L..N S. 6

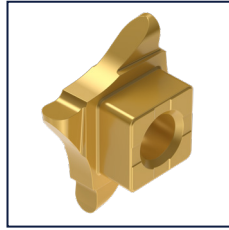

OFQE R/L..RN S. 6

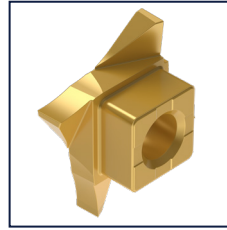

OFQE R/L..A S. 6

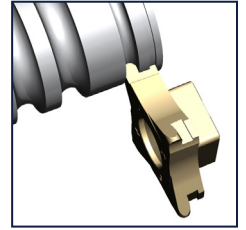

OFQE SONDER S. 7

Halter

Toolholders

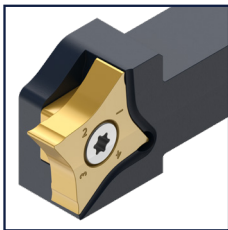

M92QE FXCBR/L S. 7

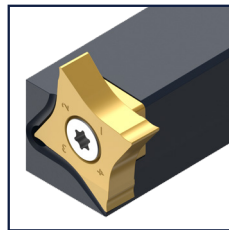

M92QE 90 FXCBR/L S. 7

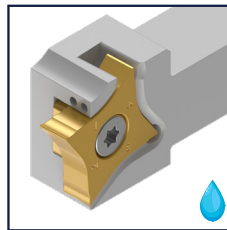

M92QE FXCBR/L HP S. 8

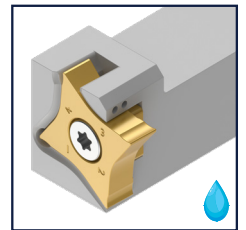

M92QE 90 FXCBR/L HP S. 8

Halter mit Innenkühlung

Toolholders with internal coolant

P92 - System Innenstechen | *Internal grooving*

2 Schneiden | *2 edges*

Bohrstangen mit Direktkühlung und kurzer Auslage

Boring bars with direct coolant and short extension



P92 CAR/L HP S. 9



P92 CSR/L HP S. 9

P92 P - System Stechbreite 8 mm | *Cutting width 8 mm*

2 Schneiden | *2 edges*

Radiusformplatten + SONDER

Radiusform inserts + special applications

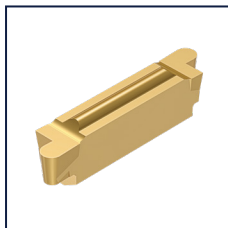

OTX 8 R S. 10

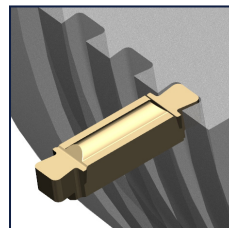

OTX 8 SONDER S. 11

Halter und Bohrstangen

Toolholders and boring bars

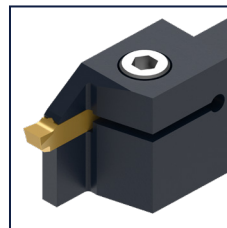

P92 P CXCBR/L..8 S. 10

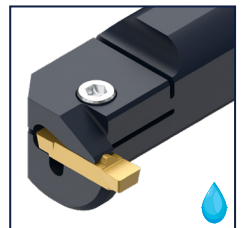

P92 P CGR/L..8 S. 11

KEMMER Next Generation Coating

HARD SX3

CARBO SX2

HARDLOX2

CARBOSPEED

SX3 ▶ SPEED EXCELLENCE GENERATION 3

Deutliche Vorteile durch HiPIMS Beschichtungsverfahren
Significant advantages through HiPIMS coating process

haftungsstärker
more adhesive

glatter
smoother

dichter
denser

ab S. 12		P92 - Stechen und Stehdrehen <i>P92 - Grooving and turning</i>	CARBO SX2	P
ab S. 15		P92 - Stechen und Stehdrehen <i>P92 - Grooving and turning</i>	HARD SX3	H
S. 18		P92 S - Stechen und Stehdrehen <i>P92 S - Grooving and turning</i>	HARD SX3	H
S. 19		MULTICUT 4 - Axialsteckplatten <i>MULTICUT 4 - Inserts for face grooving</i>	CARBO SX2	P
ab S. 20		MULTICUT 4 - Ein- und Abstechen, Radius, Präzi, Gewinde <i>MULTICUT 4 - Parting off, grooving, radius, precision, threading</i>	HARD SX3	H
S. 23		Standard Design - Abstechen, Nutendrehen <i>Standard Design- Parting off, grooving</i>	CARBO SX2	P
S. 24		FLEX FIX - Abstechen, Nutendrehen <i>FLEX FIX - Parting off, grooving</i>	CARBO SX2	P

MULTICUT 4 Stechplatten Benennungsschlüssel | MULTICUT 4 Insert designation code

O F Q E 16 R 000 000 R 00 TILOX

Spanleitstufe Chip breaker	Beschichtungsart Coating
4 Schneiden 4-edges	Einstellwinkel an der Hauptschneide Lead angle
WSP System: quadratisch vertikal square and vertical	Drehrichtung Rotation
Extended	Eckenradius an der Hauptschneide Corner Radius
Innenkreis Ø 16 (Plattensitzgröße) Inside diameter Ø 16 (pocket size)	Breite der Hauptschneide Cutting width
	Schneidkörper rechts Right hand insert

MULTICUT 4 Werkzeug Benennungsschlüssel | MULTICUT 4 tools designation code

M92 Q E FXCB L 2020 M 16

Werkzeugfamilie Tool family	Innenkreis Ø 16 (Plattensitzgröße) Inside diameter Ø 16 (pocket size)
Stechplattentyp MULTICUT 4 Insert type MULTICUT 4	ISO Halterlänge ISO-Code length of holder
Extended	Schaftmaße Shank dimension
Stechhalter mit kraftschlüssiger Spannung für 4-schneidige Platten Screw clamped holder for inserts with 4-edges	Drehrichtung Rotation

Vorteile des MULTICUT-Systems | Advantages of the MULTICUT-system

<p>OFQ max. 3,5 mm</p>	<ul style="list-style-type: none"> Perfekte form- und kraftschlüssige Einbindung im Plattensitz Extrem hohe Festigkeit des Schneidkörpers verhindert die Entstehung von Vibrationen. Erzielt werden gleichbleibend hohe Standzeiten und Prozesssicherheit. 	<ul style="list-style-type: none"> Perfect power and form actuated clamping. Reinforced solidity of inserts suppresses vibrations. Achieves high and consistent tool life. Maintains reliability on cutting operations.
<p>OFQ E max. 6,5 mm</p>	<ul style="list-style-type: none"> Die flächige Versteifung verhindert die Abweichung der vorkragenden Schneiden. Erzielt wird dadurch ein exzellenter Geradeauslauf sowie saubere Drehflächen. Bei Schneidenbruch können alle unbenutzten Schneiden völlig uneingeschränkt weiterverwendet werden. 	<ul style="list-style-type: none"> Reinforced area of the cutting edge grants stability. In case a cutting edge is damaged all other edges can be used independently.
	<ul style="list-style-type: none"> Präzise Repositionierung nach dem Schneidenwechsel Schnelle und sichere Montage im Plattensitz Nur 1 Plattensitz für zahlreiche verschiedene Fertigungsaufgaben NEU Extended Version bis Stechbreite 6,5 mm für breite Kontureinstiche, Radiusformen und kundenspezifische Anwendungen. 	<ul style="list-style-type: none"> Precise re-positioning when changing cutting edges. Fast and safe fixing in pocket. Only one insert pocket for many inserts and different cutting operations. NEW Extended version up to cutting width 6,5 mm for wide profile cutting, radius form and customer specific - tailor made - applications.

MULTICUT 4 - EXTENDED | PRÄZI Einstechplatten bis Nutbreite 4,15 mm
Precision grooving inserts up to 4,15 mm width

OFQE16L..N

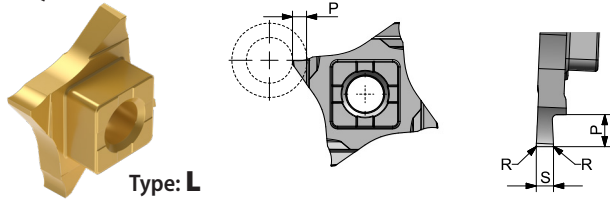

Type: **L**

OFQE16R..N

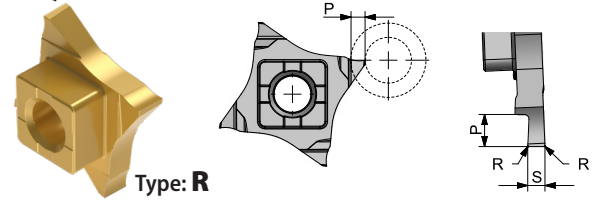

Type: **R**

WG400 Bezeichnung	FM NANOSPEED ID-Nr.	FM TILOX ID-Nr.	Plattensitz- größe pocket size	()	P	R		S -0,05
OFQE16R 415 010 N	65565	65566	16ER	R	3,5	0,10	4,15	4,29
OFQE16L 415 010 N	65563	65564	16EL	L	3,5	0,10	4,15	4,29

MULTICUT 4 - EXTENDED | Vollradius Einstech- und Kopierplatten bis Stechbreite 6 mm
Fullradius inserts for grooving and copying up to 6 mm width

OFQE16L..R..N

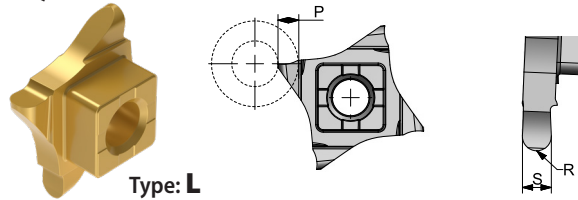

Type: **L**

OFQE16R..R..N

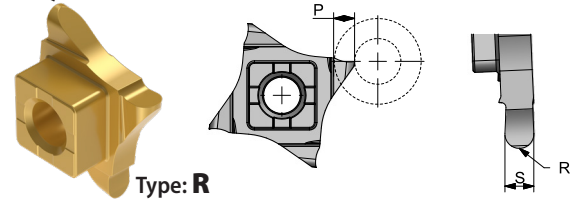

Type: **R**

WG400 Bezeichnung Ref.	FM NANOSPEED ID-Nr.	FM TILOX ID-Nr.	Plattensitz- größe pocket size	()	P	R	S +0,05
OFQE16R 400 R200 N	64822	65557	16ER	R	4,0	2,00	4,00
OFQE16R 500 R250 N	65558	65560	16ER	R	4,0	2,50	5,00
OFQE16R 600 R300 N	65561	65562	16ER	R	4,0	3,00	6,00
OFQE16L 400 R200 N	64821	65552	16EL	L	4,0	2,00	4,00
OFQE16L 500 R250 N	65553	65554	16EL	L	4,0	2,50	5,00
OFQE16L 600 R300 N	65555	65556	16EL	L	4,0	3,00	6,00

MULTICUT 4 - EXTENDED | Axialstechplatten bis Stechbreite 5 mm
Inserts for face grooving up to 5 mm width

OFQE16L..A

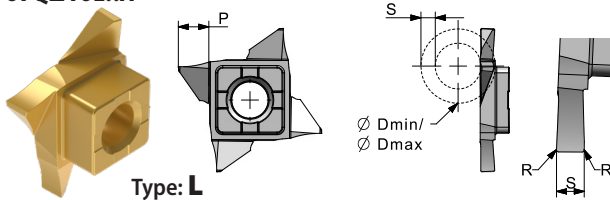

Type: **L**

OFQE16R..A

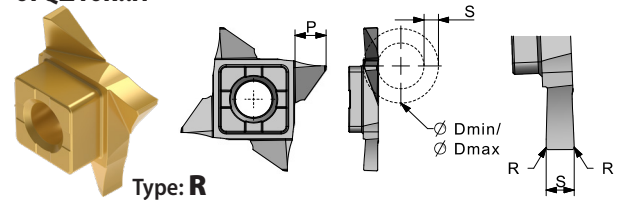

Type: **R**

WG400 Bezeichnung Ref.	KM ID-Nr.	KM NANOSPEED ID-Nr.	KM CARBOSX2 ID-Nr.	Plattensitz- größe pocket size	()	Ø min	Ø max	P	R	S +0,05
OFQE16R 400 020 A 50	65573	65574	65576	16ER	R	20	∞	5,0	0,20	4,00
OFQE16R 500 020 A 50	65578	65579	65580	16ER	R	20	∞	5,0	0,20	5,00
OFQE16L 400 020 A 50	65567	65568	65569	16EL	L	20	∞	5,0	0,20	4,00
OFQE16L 500 020 A 50	65570	65571	65572	16EL	L	20	∞	5,0	0,20	5,00

Passende Werkzeuge | *Fitting tool holders*





S.7

S.7

S.8

S.8

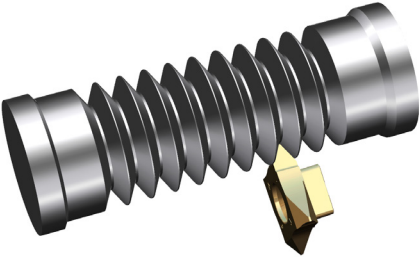
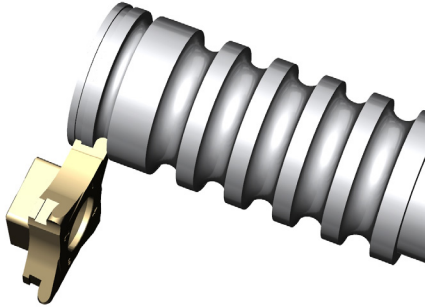
Sonderplattenbeispiele | *Examples for special inserts*

ERWEITERTE Möglichkeiten	EXTENDED possibilities
	
<p>4 Schneiden Sonderkonturen bis 6,5 mm Stechbreite. <i>4 edges special profiles up to 6,5 mm width.</i></p> <p>Ihre Anfrage <i>Your inquiry</i></p> 	

MULTICUT 4 - EXTENDED | Halter für EXTENDED Platten
Holder for EXTENDED inserts

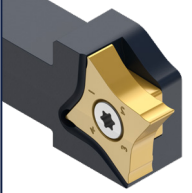
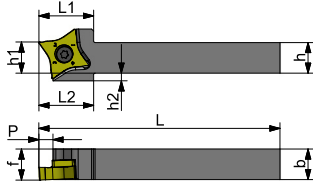
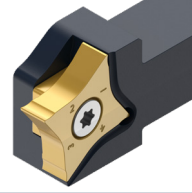
	M92QE FXCBL		M92QE FXCBR	
Links			Rechts	

WG402 Bezeichnung Ref.	ID-Nr.	Plattensitzgröße <i>pocket size</i>	()	h	h1	h2	b	f	P	L	L1	L2	
M92 QE FXCBL 1616 K16	64580	16EL	L	16	16	4	16	16,3	6,5	125	28	28	33+39+40
M92 QE FXCBL 2020 K16	64581	16EL	L	20	20	-	20	20,3	6,5	125	28	-	33+39+40
M92 QE FXCBL 2525 M16	64582	16EL	L	25	25	-	25	25,3	6,5	150	28	-	33+39+40
M92 QE FXCBR 1616 K16	64583	16ER	R	16	16	4	16	16,3	6,5	125	28	28	33+39+40
M92 QE FXCBR 2020 K16	64584	16ER	R	20	20	-	20	20,3	6,5	125	28	-	33+39+40
M92 QE FXCBR 2525 M16	64585	16ER	R	25	25	-	25	25,3	6,5	150	28	-	33+39+40

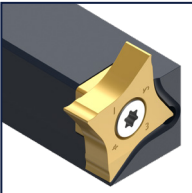
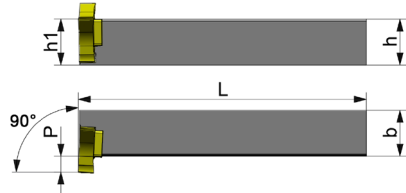
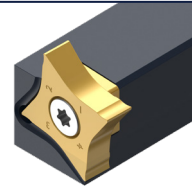
	M92QE 90 FXCBL		M92QE 90 FXCBR	
Linker Halter für Schneidkörper rechts <i>LH holder for RH inserts</i>			Rechter Halter für Schneidkörper links <i>RH holder for LH inserts</i>	

WG402 Bezeichnung Ref.	ID-Nr.	Plattensitzgröße <i>pocket size</i>	()	h	h1	b	P	L	
M92 QE 90 FXCBL 2020 K16	64576	16ER	L	20	20	20	6,5	125	33+39+40
M92 QE 90 FXCBL 2525 M16	64577	16ER	L	25	25	25	6,5	150	33+39+41
M92 QE 90 FXCBR 2020 K16	64578	16EL	R	20	20	20	6,5	125	33+39+40
M92 QE 90 FXCBR 2525 M16	64579	16EL	R	25	25	25	6,5	150	33+39+41

90° Halter für Axialbearbeitung oder spezielle Anwendungen
90° holder for face grooving or special applications

Passende Platten | Fitting inserts

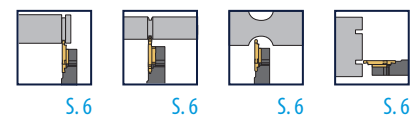

MULTICUT 4 - EXTENDED | Halter mit Innenkühlung für EXTENDED Platten
Holder with internal coolant for EXTENDED inserts

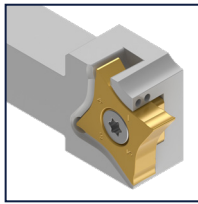

M92QE FXCBL..HP

Links | *left*

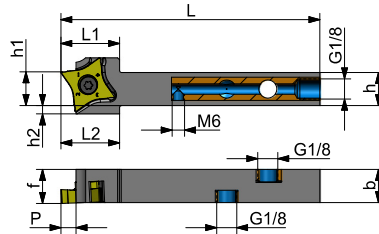

M92QE FXCBL..HP

Rechts | *right*

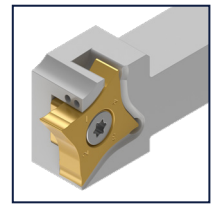

WG4020 Bezeichnung Ref.	ID-Nr.	Plattensitz- größe pocket size	()	h	h1	h2	b	f	P	L	L1	L2	
M92 QE FXCBL 1616 K16 HPG1/8	64569	16EL	L	16	16	4	16	16,3	6,5	125	28	28	33+39+40
M92 QE FXCBL 2020 K16 HPG1/8	64570	16EL	L	20	20	-	20	20,3	6,5	125	28	-	33+39+40
M92 QE FXCBL 2525 M16 HPG1/8	64571	16EL	L	25	25	-	25	25,3	6,5	150	28	-	33+39+40
M92 QE FXCBL 1616 K16 HPG1/8	64572	16ER	R	16	16	4	16	16,3	6,5	125	28	28	33+39+40
M92 QE FXCBL 2020 K16 HPG1/8	64573	16ER	R	20	20	-	20	20,3	6,5	125	28	-	33+39+40
M92 QE FXCBL 2525 M16 HPG1/8	64574	16ER	R	25	25	-	25	25,3	6,5	150	28	-	33+39+40

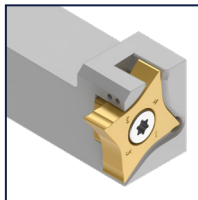

M92QE 90 FXCBL..HP

Linker Halter für
Schneidkörper rechts
LH holder for RH inserts

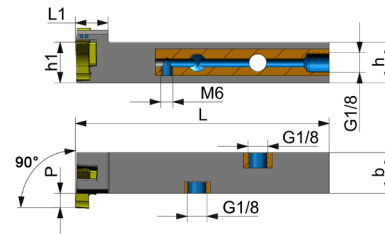

M92QE 90 FXCBL..HP

Rechter Halter für
Schneidkörper links
RH holder for LH inserts

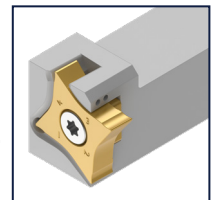

WG4020 Bezeichnung Ref.	ID-Nr.	Plattensitz- größe pocket size	()	h	h1	b	P	L	L1	
M92 QE90 FXCBL 2020 K16 HPG1/8	64565	16ER	L	20	20	20	6,5	125	16	33+39+40
M92 QE90 FXCBL 2525 M16 HPG1/8	64566	16ER	L	25	25	25	6,5	150	16	33+39+41
M92 QE90 FXCBL 2020 K16 HPG1/8	64567	16EL	R	20	20	20	6,5	125	16	33+39+40
M92 QE90 FXCBL 2525 M16 HPG1/8	64568	16EL	R	25	25	25	6,5	150	16	33+39+41

90° Halter für Axialbearbeitung oder spezielle Anwendungen
90° holder for face grooving or special applications

Passende Platten | Fitting inserts

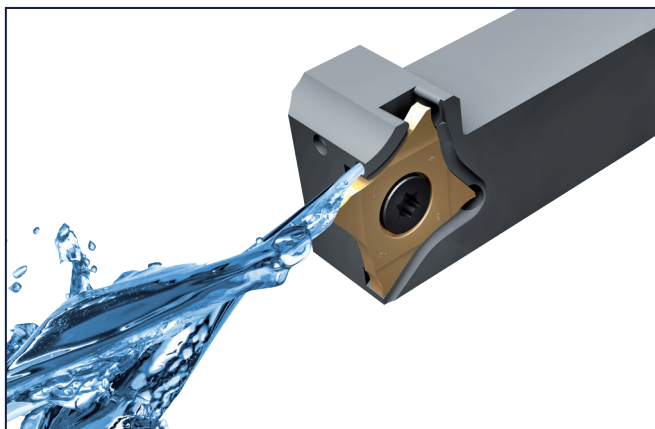

Vorteile Innenkühlung

- Gezielte Kühlung der Schneide
- Bessere Spanabfuhr
- Weniger Wärmeentwicklung

Advantages direct coolant

- *More efficient cooling of the cutting edge*
- *Better chip control*
- *Less heat development*

P92 | Bohrstangen für kurze Auslagen mit Direktkühlung
Boring bars for short extension with direct coolant

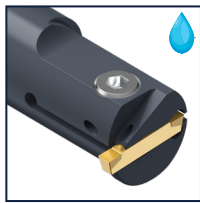

P92 CAL

Links | left

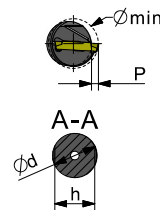
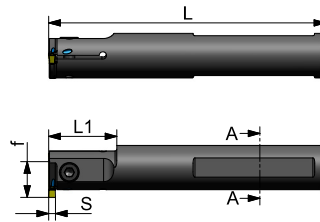

P92 CAR

Rechts | right

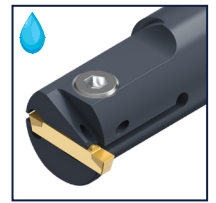

WG3905 Bezeichnung Ref.	ID-Nr.	Plattensitz- größe pocket size	()	Ømin	Ø d	h	f	P	S	L	L1	
P92 CAL 0020 K30 HP	64932	30	L	22	20	18	13,5	3	3,0	125	30	6
P92 CAL 0025 M30 HP	64934	30	L	25	25	23	17,5	4,5	3,0	150	40	6
P92 CAR 0020 K30 HP	64933	30	R	22	20	18	13,5	3	3,0	125	30	6
P92 CAR 0025 M30 HP	64935	30	R	25	25	23	17,5	4,5	3,0	150	40	6



CA (rückseitiger Exzenter)

Borstange Typ CA für Operationen in kleinen Durchmessern und kurzen Stechtiefen.

Boring bars type CA for applications with small diameters and short cutting depths.

Passende Platten | Fitting inserts

Aktueller GripLock Katalog | Current GripLock catalogue
und hier im Prospekt | and here in the brochure



S. 61-70
S. 15



S. 71



S. 74-80
S. 13-15



S. 16-18

Wichtig beim Innenstechen

- Kurze Auslage
- Möglichst stabiler Halterquerschnitt (Ømin beachten)
- Kühlung

Good performance in internal grooving applications

- Short extension
- Stable shank size (see Ømin)
- Coolant



Direktkühlung
Direct coolant

P92 | Bohrstangen verstärkt mit Direktkühlung zum Einstechen und Längsdrehen
Boring bars with direct coolant for grooving and turning



P92 CSL

Links | left

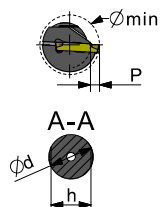
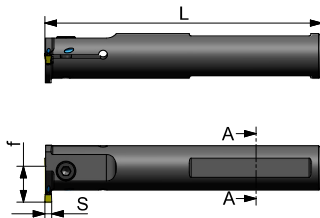

P92 CSR

Rechts | right



WG3905 Bezeichnung Ref.	ID-Nr.	Plattensitz- größe pocket size	()	Ømin	Ø d	h	f	P	S	L	
P92 CSL 0020 K30 HP	64900	30	L	27	20	18	15,5	5	3,0	125	6
P92 CSL 0025 M30 HP	64902	30	L	33	25	23	19	6	3,0	150	1
P92 CSL 0025 M40 HP	64904	40	L	33	25	23	19	6	4,0	150	1
P92 CSL 0032 M30 HP	64906	30	L	42	32	30	24,5	8	3,0	150	14
P92 CSL 0032 M40 HP	64908	40	L	42	32	30	24,5	8	4,0	150	14
P92 CSR 0020 K30 HP	64901	30	R	27	20	18	15,5	5	3,0	125	6
P92 CSR 0025 M30 HP	64903	30	R	33	25	23	19	6	3,0	150	1
P92 CSR 0025 M40 HP	64905	40	R	33	25	23	19	6	4,0	150	1
P92 CSR 0032 M30 HP	64907	30	R	42	32	30	24,5	8	3,0	150	14
P92 CSR 0032 M40 HP	64909	40	R	42	32	30	24,5	8	4,0	150	14



CS (ohne Exzenter)

Bohrstange Typ CS für Operationen mit verstärkter Ausführung (ohne Exzenter)

Boring bars type CS for applications with reinforced shank.

Passende Platten | Fitting inserts

Aktueller GripLock Katalog | Current GripLock catalogue
und hier im Prospekt | and here in the brochure



S. 61-70
S. 15



S. 71



S. 74-80
S. 13-15



S. 16-18

P92 P | Präzisionstechen mit Stechbreite 8 mm
Precision grooving with cutting width 8 mm

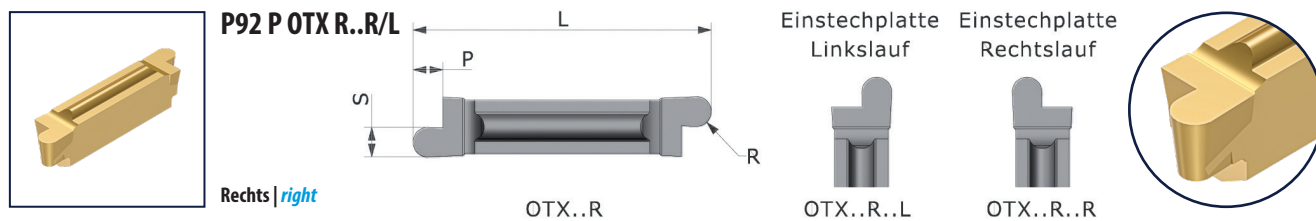

WG260 Bezeichnung Ref.	KM NANOSPEED	Plattensitz- größe pocket size	()	L ^{-0,1}	P	R	S ^{+0,05}
OTX 8 R 350L	65066	P80	L	28,6	5,0	3,50	7,00
OTX 8 R 350R	65067	P80	R	28,6	5,0	3,50	7,00
OTX 8 R 400N	65068	P80	R+L	28,6	14	4,00	8,00

Radiusformstechen mit
PRÄZI - Anschlag bis 8 mm

Radiusform grooving up to 8 mm
with precise insert pocket P92 P

Passende Werkzeuge | Fitting tool holders

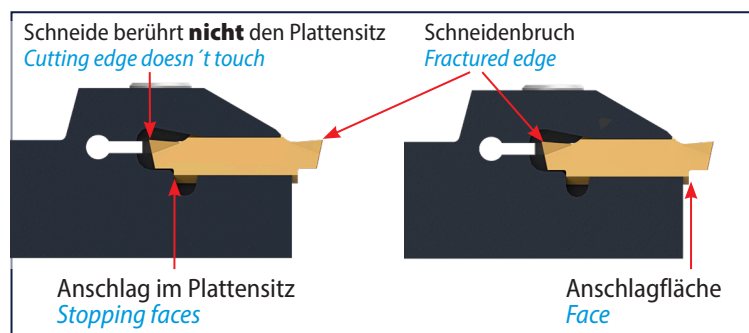

- Präzise Repositionierung der Schneide
- Bei Plattenbruch kann die zweite, noch unbenutzte Schneide, weiterverwendet werden.
- *Precise repositioning of the cutting edge*
- *In case of an edge break, the 2nd edge can be used independently.*

P92 P | Halter für Stechbreite 8 mm
Holders for cutting width 8 mm

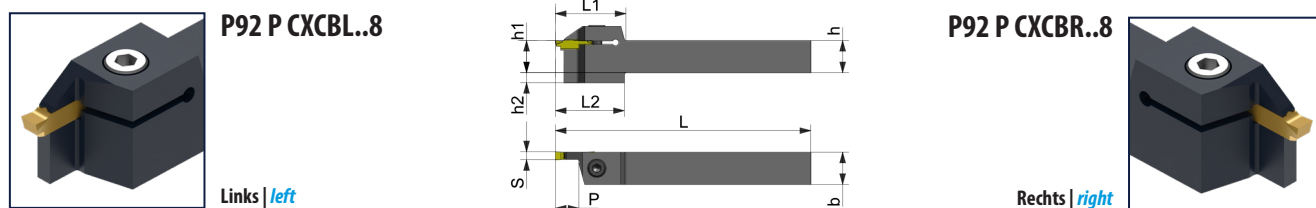

WG380 Bezeichnung Ref.	ID-Nr.	Plattensitz- größe pocket size	()	h	h1	h2	b	P	S	L	L1	L2	
P92 P CXCBL 2020 M8	64418	P80	L	20	20	5	20	20	8	150	45	45	2
P92 P CXCBL 2525 M8	64420	P80	L	25	25	-	25	20	8	150	48	-	3
P92 P CXCBL 3232 P8	64422	P80	L	32	32	-	32	20	8	170	48	-	3
P92 P CXCBR 2020 M8	64417	P80	R	20	20	5	20	20	8	150	45	45	2
P92 P CXCBR 2525 M8	64419	P80	R	25	25	-	25	20	8	150	48	-	3
P92 P CXCBR 3232 P8	64421	P80	R	32	32	-	32	20	8	170	48	-	3

Vierkanthalter für die Außen-
bearbeitung

Holder for external machining

Passende Platten | Fitting inserts



S. 10

P92 P | Bohrstangen für Stechbreite 8 mm
Boring bars for cutting width 8 mm

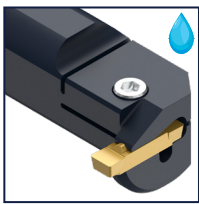

P92 P CGL..8

Links | *left*

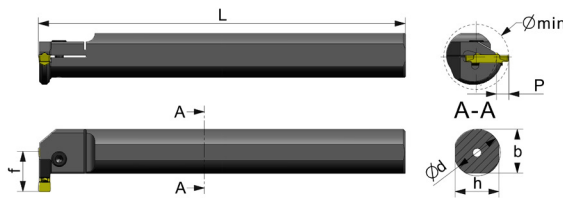

P92 P CGR..8

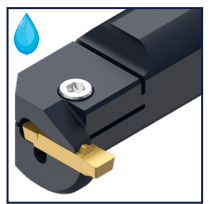

Rechts | *right*

WG390 Bezeichnung Ref.	ID-Nr.	Plattensitz- größe pocket size	(C)	Ømin	d	h	b	f	P	S	L	
P92 P CGL 0032 S8	64424	P80	L	44	32	30	30	26	11,5	8	250	14
P92 P CGL 0040 T8	64426	P80	L	52	40	38	38	30	11,5	8	300	2
P92 P CGR 0032 S8	64423	P80	R	44	32	30	30	26	11,5	8	250	14
P92 P CGR 0040 T8	64425	P80	R	52	40	38	38	30	11,5	8	300	2

Bohrstangen für die Innen-
bearbeitung

*Boring bars for the internal
machining*

Passende Platten | *Fitting inserts*



S. 10

P92 P | Beispiele für Sonderkonturen bis Stechbreite 8mm
Examples for special inserts up to 8 mm width

Innenbearbeitung
Internal machining

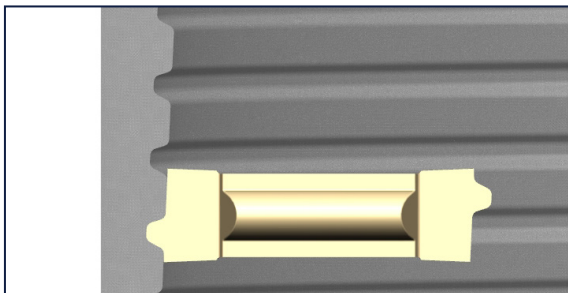

Oil & Gas Gewinde | *Threading*

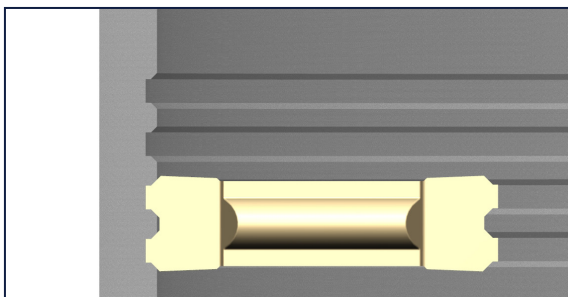

Doppeleinstich mit Fasen
Double sided grooving with chamfer

Außenbearbeitung
External machining

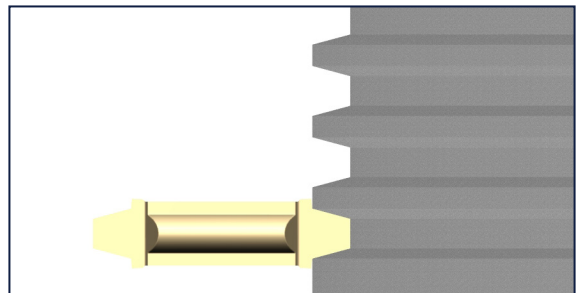

Keilrippenprofil | *V - Pulley profile*

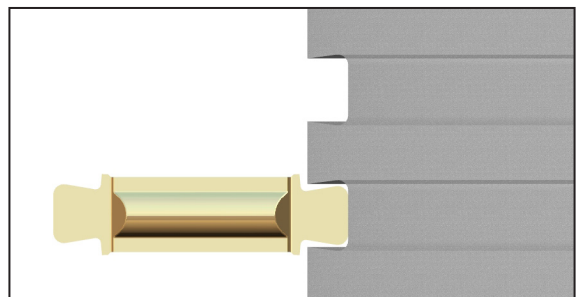

Schwalbenschwanzkontur
Dovetail profile

Ihre Anfrage | *Your inquiry*
sonder@kemmerhmw.de



KEMMER Next Generation Coating

HARD SX3

HARDLOX2

CARBO SX2

CARBOSPEED

SX3 ▶ SPEED EXCELLENCE GENERATION 3

Deutliche Vorteile durch HiPIMS Beschichtungsverfahren
Significant advantages through HiPIMS coating process

haftungsstärker
more adhesive

glatter
smoother

dichter
denser

HARD SX3

Die Nachfolgegengeneration der bewährten HARDLOX2 Schicht.
Ideal für die Bearbeitung von harten und schwierigen Materialien.

Technische Daten:

Beschichtungstechnologie: **HiPIMS**
 Schichtzusammensetzung: **TiAlSiN-basiert**
 Farbe: **Rotgold**
 Max. Einsatztemperatur: **1.100 °C**
 Schichtdicke: **≈ 3 µm**

*The new generation of the former HARDLOX2 coating.
Perfect for hard machining and difficult operations.*

Technical data:

Coating technology: **HiPIMS**
 Coating composing: **TiAlSiN-based**
 Colour: **Rotgold**
 Max. temperature: **1.100 °C**
 Coating width: **≈ 3 µm**

CARBO SX2

Die Nachfolgegengeneration der bewährten CARBOSPEED Schicht.
Ideal für alle Arten der Stahlzerspanung.

Technische Daten:

Beschichtungstechnologie: **HiPIMS**
 Schichtzusammensetzung: **AlTiN-basiert**
 Farbe: **Anthrazit**
 Max. Einsatztemperatur: **1.100 °C**
 Schichtdicke: **≈ 3 µm**

*The new generation of the former CARBOSPEED coating.
Perfect for all kinds of steel applications.*

Technical data:

Coating technology: **HiPIMS**
 Coating composing: **AlTiN-based**
 Colour: **Anthrazit**
 Max. temperature: **1.100 °C**
 Coating width: **≈ 3 µm**

P92 | Stechplatten mit 2 Schneiden zum Ab- und Einstechen
Inserts with 2 edges for parting off and grooving



BTNN
BTNNF

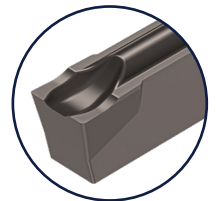
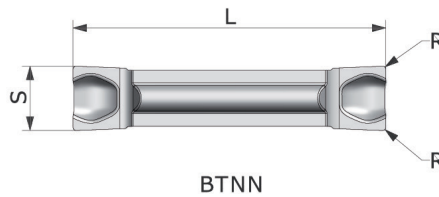

WG300 Bezeichnung Ref.	KM CARBO SX2	GF110 CARBO SX2	Plattensitz- größe pocket size	(C)	L ±0,15	R	S ±0,10
	ID-Nr.	ID-Nr.					
BTNN 1,5	65151	65155	15	N	15,50	0,2	1,58
BTNN 2	65153	65157	20	N	20,00	0,2	2,08
BTNN 2,5	65152	65156	20	N	20,00	0,2	2,58
BTNN 3	65159	65158	30	N	20,00	0,2	3,08
BTNN 4	65154	65160	40	N	20,00	0,2	4,08
BTNNF1,5	-	65161	15	N	15,10	0,0	1,575
BTNNF 2	-	65163	20	N	19,60	0,0	2,075
BTNNF 2,5	-	65162	20	N	19,60	0,0	2,575
BTNNF 3	-	65164	30	N	19,60	0,0	3,075

BTN - Stechgeometrie

Genutete Stechschneide mit verstärkten Flanken und geräumiger, muldenförmiger Spankammer. Sehr gute Spankontrolle bei nahezu allen Zerspanungsmaterialien.



Passende Werkzeuge

GripLock Katalog 2020 | *GripLock catalogue 2020*

BTN Parting off chip breaker

Grooved parting off edge with reinforced flanks. The deep and spacious chip-trough gives excellent chip control. Efficient on almost all materials.

<p>Typ BTNN</p> <p>Eckenradius <i>Corner radius</i></p>	<p>Typ BTNNF</p> <p>Kein Eckenradius <i>Sharp edge without radius</i></p>
<p>Unterschied zwischen BTNN und BTNNF: Die Ausführung F steht für eine besonders scharfe Schneidenausführung. Diese eignet sich besonders bei harten und zähen Materialien sowie für Automatenstähle.</p> <p>The difference BTNN and BTNNF: <i>F marks an especially sharp edge. This is recommended for hard and tough materials and also for machining steels.</i></p>	

<p>Der schwierige Weg zur Drehmitte</p> <ul style="list-style-type: none"> • Schnittgeschwindigkeit geht gegen Null • Schwierige Kühlung • Schlechte Spanabfuhr <p>Vorteil BTNN.. Die tiefe muldenförmige Spankammer der BTNN.. erzeugt eine hervorragende Spanbildung und saubere Abstichflächen. Dadurch können bessere Abstichoberflächen erzielt und höhere Standzeiten erreicht werden!</p>	<p>The way towards the center isn't easy at all: <i>When beginning the operation all conditions are ideal:</i></p> <ul style="list-style-type: none"> • cutting speed (Vc) • cooling and • chip removal <p>BTN Parting off chip breaker <i>Grooved parting off edge with reinforced flanks. The deep and spacious chip-trough gives excellent chip control. Efficient on almost all materials.</i></p>
---	---

P92 | Stechplatten mit 2 Schneiden zum Ab- und Einstechen
Inserts with 2 edges for parting off and grooving



CTD R/L IT

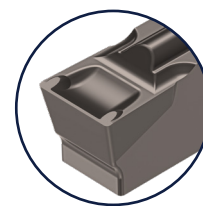
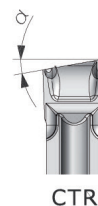
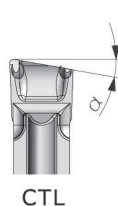
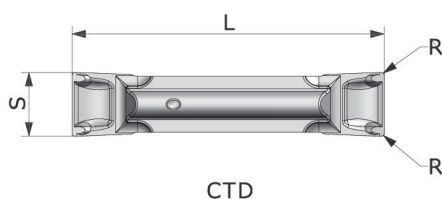

WG300 Bezeichnung Ref.	GF110 CARBO SX2 ID-Nr.	PM CARBO SX2 ID-Nr.	Plattensitz- größe pocket size	()	L	R	S ^{±0,10}	α°
CTD 1,5	65165	65166	15	N	15,5	0,15	1,58	0
CTD 2	65169	65170	20	N	20,0	0,2	2,08	0
CTD 2,5	65167	65168	20	N	20,0	0,2	2,58	0
CTD 3	65171	65172	30	N	20,0	0,2	3,08	0
CTD 4	65173	65174	40	N	20,0	0,2	4,08	0
CTD 5	65175	65176	50	N	25,0	0,2	5,13	0
CTL 1,5 6D	65177	-	15	L	15,5	0,15	1,58	6
CTL 2 6D	65179	-	20	L	20,0	0,2	2,08	6
CTL 2,5 6D	65178	-	20	L	20,0	0,2	2,58	6
CTL 3 6D	65180	-	30	L	20,0	0,2	3,08	6
CTL 4 6D	65181	-	40	L	20,0	0,2	4,08	6
CTL 5 6D	65182	-	50	L	25,0	0,2	5,13	6
CTR 1,5 6D	65183	-	15	R	15,5	0,15	1,58	6
CTR 2 6D	65185	-	20	R	20,0	0,2	2,08	6
CTR 2,5 6D	65184	-	20	R	20,0	0,2	2,58	6
CTR 3 6D	65186	-	30	R	20,0	0,2	3,08	6
CTR 4 6D	65187	-	40	R	20,0	0,2	4,08	6
CTR 5 6D	65188	-	50	R	25,0	0,2	5,13	6

Classic - Stechgeometrie

Horizontale, gefaste Hauptschneide mit verstärkten Flanken und geräumiger Spankammer. Besonders geeignet für legierte Stähle und unterbrochene Schnitte.

Passende Werkzeuge

GripLock Katalog 2020 | *GripLock catalogue 2020*



Classic chip breaker

Horizontal, chamfered parting off edge with reinforced flanks and large chip breaker. To be used universally and especially on interrupted cuts and alloyed steels.



LTNN

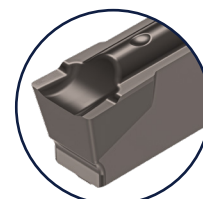
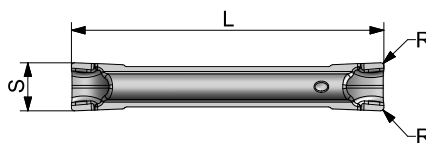

WG300 Bezeichnung Ref.	GF110 CARBOSX2 ID-Nr.	Plattensitz- größe pocket size	()	L	R	S ^{+0,10}
LTNN 1.5	65202	15	N	15,5	0,15	1,575
LTNN 2	65203	20	N	20,0	0,2	2,075
LTNN 3	65204	30	N	20,0	0,2	3,075

LTN - Stechgeometrie

Zum Abstechen langspanender Materialien. Besonders geeignet für Doppelspindelmaschinen.

Passende Werkzeuge

GripLock Katalog 2020 | *GripLock catalogue 2020*

LTN Parting off geometry

For parting off long chipping materials. Especially recommended for double-spindle lathes.



P92 | Stechplatten mit 2 Schneiden zum Ab- und Einstechen
Inserts with 2 edges for parting off and grooving



SCTD

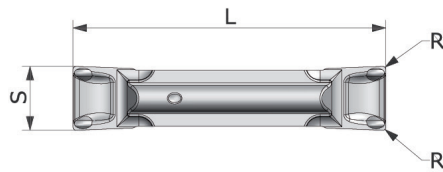

SCTD

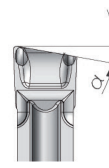

SCTL

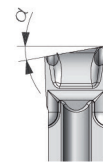

SCTR

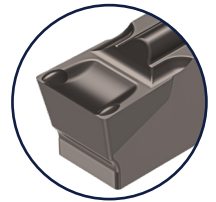

WG300 Bezeichnung Ref.	GF110 CARBOSX2	KM CARBOSX2	PM CARBOSX2	Plattensitz- größe pocket size	()	L	R	S ±0,10	α°
SCTD 1,5	ID-Nr. 65232	-	ID-Nr. 65233	15	N	15,5	0,15	1,58	0
SCTD 2	65236	-	65237	20	N	20	0,2	2,08	0
SCTD 2,5	65234	-	65235	20	N	20	0,2	2,58	0
SCTD 3,0	65238	65239	65240	30	N	20	0,2	3,08	0
SCTD 4,0	65241	65242	65243	40	N	20	0,2	4,08	0
SCTD 5,0	65244	65245	65246	50	N	25	0,2	5,13	0
SCTL 1,5 6D	-	-	65247	15	L	15,5	0,15	1,58	6
SCTL 2 6D	-	-	65249	20	L	20	0,2	2,08	6
SCTL 2,5 6D	-	-	65248	20	L	20	0,2	2,58	6
SCTL 3,0 6D	-	-	65250	30	L	20	0,2	3,08	6
SCTR 1,5 6D	-	-	65251	15	R	15,5	0,15	1,58	6
SCTR 2 6D	-	-	65253	20	R	20	0,2	2,08	6
SCTR 2,5 6D	-	-	65252	20	R	20	0,2	2,58	6
SCTR 3,0 6D	-	-	65254	30	R	20	0,2	3,08	6

SUPERNOVA - Stechgeometrie

Gehonnte Hauptschneide mit verstärkten Flanken und geräumiger Spankammer. Besonders geeignet für legierte Stähle.

Passende Werkzeuge

GripLock Katalog 2020 | GripLock catalogue 2020



S. 88 - 89 S. 90 - 94 S. 96 - 98 S. 101-104 S. 105 S. 106 S. 113-116 S. 118 S. 194 S. 220

SUPERNOVA - Parting off geometry

Slightly honed cutting edge with reinforced flanks and large chip through.

P92 | Stechdrehplatten zum Axial-Einstecken und Abstecken
Inserts for face grooving and parting off



GTNS

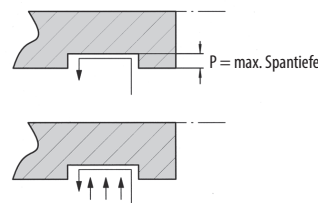
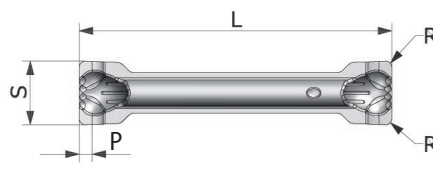

WG300 Bezeichnung Ref.	GF110 CARBOSX2	PM CARBOSX2	Plattensitz- größe pocket size	()	P	L	R	S ±0,10
GTNS 302	ID-Nr. 65190	ID-Nr. 65189	30	N	1,2	20,0	0,2	3,075
GTNS 404	65191	65190	40	N	1,2	20,0	0,4	4,075
GTNS 504	65193	65194	50	N	1,2	25,0	0,4	5,125

Passende Werkzeuge

GripLock Katalog 2020 | GripLock catalogue 2020



S. 88 - 89 S. 90 - 94 S. 96 - 98 S. 101-104 S. 105 S. 106 S. 113-116 S. 118 S. 194 S. 220

P92 | Stechplatten zum Ein- und Abstechen | *Hard material machining*
Inserts for parting off and grooving | Hard material machining



BTNN

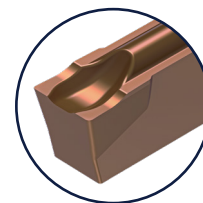
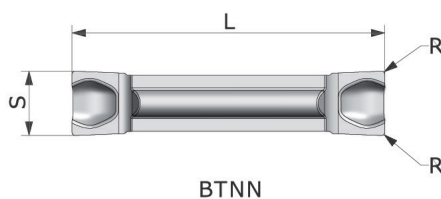

WG302 Bezeichnung Ref.	KM HARDSX3	Plattensitz- größe pocket size	(C)	L ±0,10	R	S ±0,10
	ID-Nr.					
BTNN1,5	65268	15	N	15,5	0,15	1,575
BTNN 2	65270	20	N	20,0	0,2	2,075
BTNN 2,5	65269	20	N	20,0	0,2	2,575
BTNN 3	65315	30	N	20,0	0,2	3,075
BTNN 4	65271	40	N	20,0	0,2	4,075



SCTD

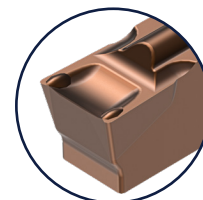
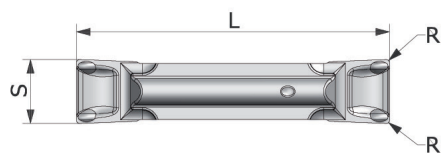

WG302 Bezeichnung Ref.	GF110 HARDSX3	Plattensitz- größe pocket size	(C)	L	R	S ±0,10
	ID-Nr.					
SCTD 1,5	65399	15	N	15,5	0,15	1,575
SCTD 2	65401	20	N	20,0	0,2	2,075
SCTD 2,5	65400	20	N	20,0	0,2	2,575
SCTD 3,0	65402	30	N	20,0	0,2	3,075
SCTD 4,0	65403	40	N	20,0	0,2	4,075
SCTD 5,0	65404	50	N	25,0	0,2	5,125

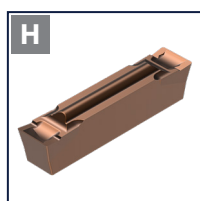

CTD ALU

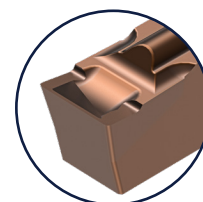
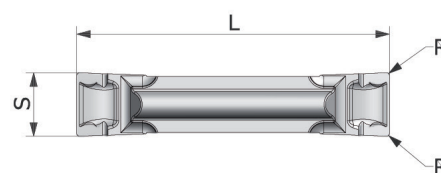

WG302 Bezeichnung Ref.	GF110 HARDSX3	Plattensitz- größe pocket size	(C)	L	R	S ±0,10
	ID-Nr.					
CTD 1.5 ALU	65316	15	N	15,5	0,15	1,575
CTD 2 ALU	65318	20	N	20,0	0,2	2,075
CTD 2.5 ALU	65317	20	N	20,0	0,2	2,575
CTD 3 ALU	65319	30	N	20,0	0,2	3,075
CTD 4 ALU	65320	40	N	20,0	0,2	4,075
CTD 5 ALU	65281	50	N	25,0	0,2	5,125

ALU - Geometrie

Horizontale, geschliffene Schneide mit angeflachter Spankammer für Highspeed-Spanabfuhr.

ALU - Geometry

Horizontal ground cutting edge. The flat chip chamber conveys chips at high speed.

Passende Werkzeuge

GripLock Katalog 2020 | *GripLock catalogue 2020*



S. 88 - 89 | S. 90 - 94 | S. 96 - 98 | S. 101-104 | S. 105 | S. 106 | S. 113-116 | S. 118 | S. 194 | S. 220

P92 | Stechplatten zum Einstecken | Hartbearbeitung
Inserts for grooving | Hard material machining

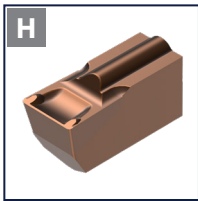

KCTD

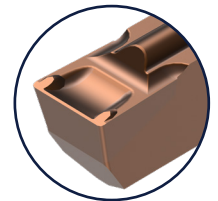
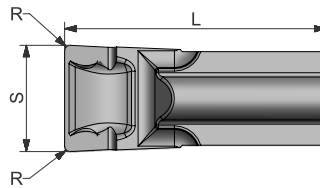

WG302 Bezeichnung Ref.	KM HARDSX3	Plattensitz- größe pocket size	(C)	P	L	R	S +0,15	Bohrstangen Ø
	ID-Nr.							
KCTD 3	65322	K30	N	3	9,5	0,2	3,0	12
KCTD 3	65322	K30	N	4,5	9,5	0,2	3,0	16
KCTD 3 MAX	65323	K30	N	5,5	12	0,2	3,0	12
KCTD 3 MAX	65323	K30	N	7	12	0,2	3,0	16

Stechplatten für kleine Durchmesser zur Innenbearbeitung.

Inserts for small diameters.

Passende Werkzeuge

GripLock Katalog 2020 | GripLock catalogue 2020



S. 108

P92 | Stechplatten zum Einstecken und Längsdrehen | Hartbearbeitung
Inserts for grooving and turning | Hard material machining



BTNG

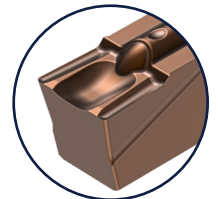
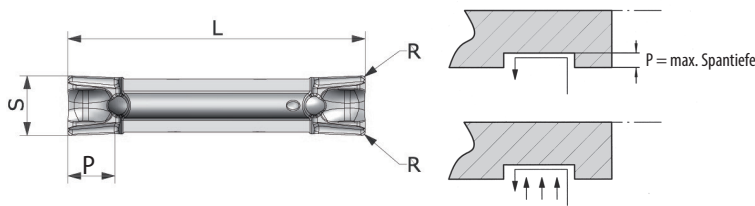

WG262 Bezeichnung Ref.	GF110 HARDSX3	Plattensitz- größe pocket size	(C)	L	P	R	S ±0,025
	ID-Nr.						
BTNG 202	65258	20	N	20,00	1,6	0,2	2,00
BTNG 302	65259	30	N	20,00	2,8	0,2	3,00
BTNG 304	65260	30	N	20,00	2,8	0,4	3,00
BTNG 402	65261	40	N	20,00	2,8	0,2	4,00
BTNG 404	65262	40	N	20,00	2,8	0,4	4,00
BTNG 408	65263	40	N	20,00	2,8	0,8	4,00
BTNG 504	65264	50	N	25,00	3,4	0,4	5,00
BTNG 508	65265	50	N	25,00	3,4	0,8	5,00
BTNG 604	65266	60	N	30,00	3,9	0,4	6,00
BTNG 808	65267	80	N	30,00	5,1	0,8	8,00

BTNG - Schichten

Genutete Hauptschneide und horizontale Nebenschneiden mit parallelen Spanstufen. Präzisionsgeschliffene Feinkornplatte, besonders geeignet für NE- und schwerzer-spanbare Materialien.

Passende Werkzeuge

GripLock Katalog 2020 | GripLock catalogue 2020



S. 88 - 89 | S. 90 - 94 | S. 96 - 98 | S. 101-104 | S. 105 | S. 106 | S. 113-116 | S. 118 | S. 194 | S. 220

BTNG - Finishing

Grooved cutting edge. Horizontal turning edges with parallel chip breakers. The precision ground micrograin insert is recommended especially for heat resistant alloys.

P92 | Stechplatten zum Einstechen und Längsdrehen | Hartbearbeitung
Inserts for grooving and turning | Hard material machining



MTNS

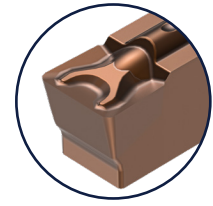
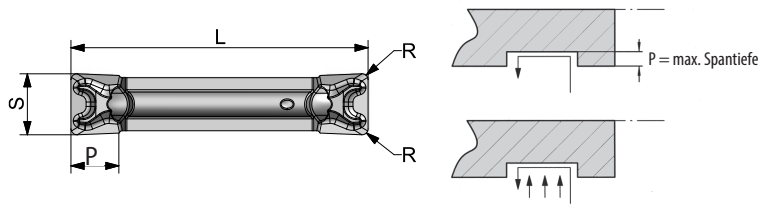

WG302 Bezeichnung Ref.	KM HARDSX3	Plattensitz- größe pocket size	(C)	L	P	R	S
	ID-Nr.						
MTNS 202	65289	20	N	20,10	1,6	0,2	2,05 ^{+0,10}
MTNS 302	65325	30	N	20,00	2,8	0,2	3,00 ^{+0,15}
MTNS 304	65326	30	N	20,00	2,8	0,4	3,00 ^{+0,15}
MTNS 402	65327	40	N	20,00	2,8	0,2	4,00 ^{+0,20}
MTNS 404	65328	40	N	20,00	2,8	0,4	4,00 ^{+0,20}
MTNS 408	65329	40	N	20,00	2,8	0,8	4,00 ^{+0,15}
MTNS 504	65290	50	N	25,00	3,4	0,4	5,00 ^{+0,25}
MTNS 508	65291	50	N	25,00	3,4	0,8	5,05 ^{+0,25}
MTNS 604	65292	60	N	30,00	3,9	0,4	6,05 ^{+0,25}
MTNS 808	65293	80	N	30,00	5,1	0,8	8,05 ^{+0,25}



RTNG

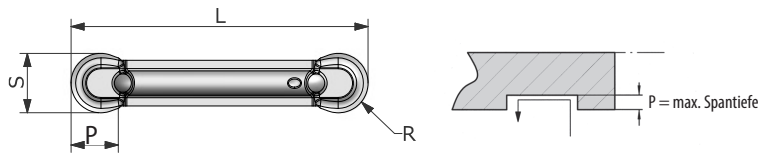

WG262 Bezeichnung Ref.	GF110 HARDSX3	Plattensitz- größe pocket size	(C)	L	P	R	S ±0,025
	ID-Nr.						
RTNG 210	65295	20	N	20,00	1,4	1,0	2,00
RTNG 315	65296	30	N	20,00	2,0	1,5	3,00
RTNG 420	65297	40	N	20,00	2,7	2,0	4,00
RTNG 525	65298	50	N	25,00	3,3	2,5	5,00
RTNG 630	65299	60	N	30,00	3,9	3,0	6,00
RTNG 840	65300	80	N	30,00	5,2	4,0	8,00
RTNG 1050	65294	100	N	30,00	6,5	5,0	10,00

Passende Werkzeuge

GripLock Katalog 2020 | *GripLock catalogue 2020*



P92 S | Stechplatten zum Ein- und Abstechen | Hartbearbeitung
Inserts for parting off and grooving | Hard material machining



ITNS

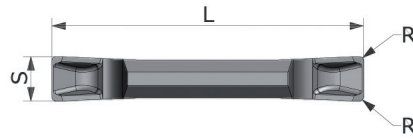

ITNS

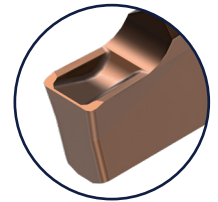

WG302 Bezeichnung	KM HARDSX3	Plattensitzgröße pocket size	()	L	R	S ±0,10
ITNS 2	ID-Nr. 65288	S20	N	14,00	0,2	2,00



STNS

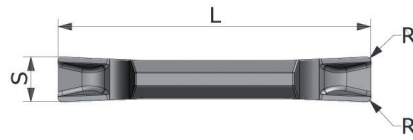

STNS

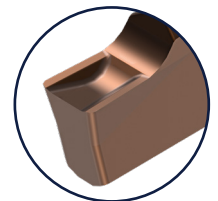

WG302 Bezeichnung Ref.	KM HARDSX3	Plattensitzgröße pocket size	()	L	R	S ±0,10
STNS 2	ID-Nr. 65301	S20	N	14,00	0,2	2,00



HTNS

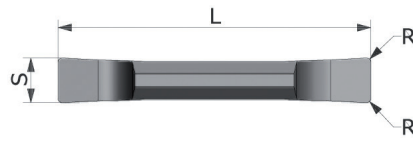

HTNS

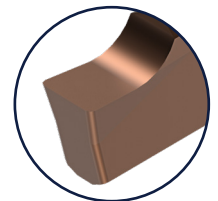

WG302 Bezeichnung Ref.	KM HARDSX3	Plattensitzgröße pocket size	()	L	R	S ±0,10
HTNS 2	ID-Nr. 65321	S20	N	14,00	0,2	2,00

Stechplatten zur Innen- und Außenbearbeitung.
Inserts for internal and external machining.

Passende Werkzeuge
GripLock Katalog 2020 | *GripLock catalogue 2020*



S. 152 | S. 153

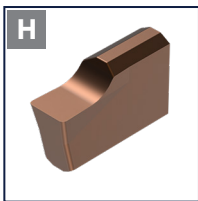

KHTNS

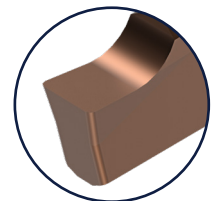
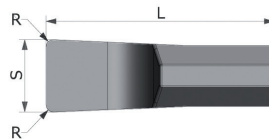

WG302 Bezeichnung Ref.	KM HARDSX3	Plattensitzgröße pocket size	()	L	R	S ±0,10
KHTNS 2	ID-Nr. 65324	SK20	N	6,35	0,2	2,0

Stechplatten für kleine Durchmesser zur Innenbearbeitung.
Inserts for small diameters and internal machining.

Passende Werkzeuge
GripLock Katalog 2020 | *GripLock catalogue 2020*



S. 155

MULTICUT 4 | Stechplatten zum Axialeinstechen
Inserts for face grooving



OFQ16L..A 50

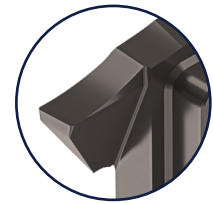
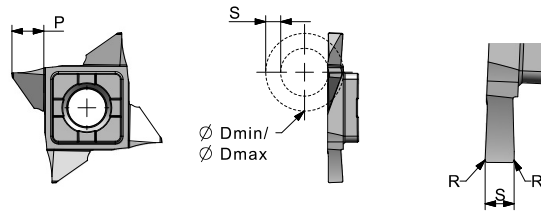

WG400 Bezeichnung Ref.	KM CARBOSX2	Plattensitz- größe pocket size	()	D min	D max	P	R	S ^{+0,05}
	ID-Nr.							
OFQ16L 150 010 A 50	65211	16L	R	15	∞	5,0	0,10	1,50
OFQ16L 200 010 A 50	65215	16L	R	20	∞	5,0	0,10	2,00
OFQ16L 250 020 A 50	65223	16L	R	20	∞	5,0	0,20	2,50
OFQ16L 300 020 A 50	65226	16L	R	20	∞	5,0	0,20	3,00



OFQ16R..A 50

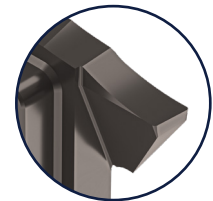
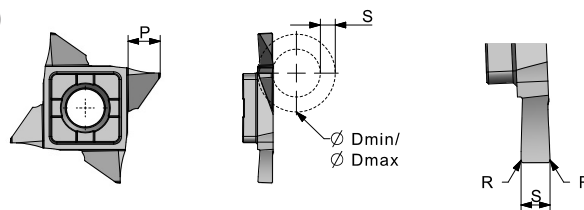

WG400 Bezeichnung Ref.	KM CARBOSX2	Plattensitz- größe pocket size	()	D min	D max	P	R	S ^{+0,05}
	ID-Nr.							
OFQ16R 150 010 A 50	65228	16R	L	15	∞	5,0	0,10	1,50
OFQ16R 200 010 A 50	65229	16R	L	20	∞	5,0	0,10	2,00
OFQ16R 250 020 A 50	65230	16R	L	20	∞	5,0	0,20	2,50
OFQ16R 300 020 A 50	65231	16R	L	20	∞	5,0	0,20	3,00

Der erste Einstich darf **nicht kleiner** als $\varnothing D \text{ min}$ sein.

*The first groove must **not be smaller** than $\varnothing D \text{ min}$.*

Passende Werkzeuge

GripLock Katalog 2020 | *GripLock catalogue 2020*

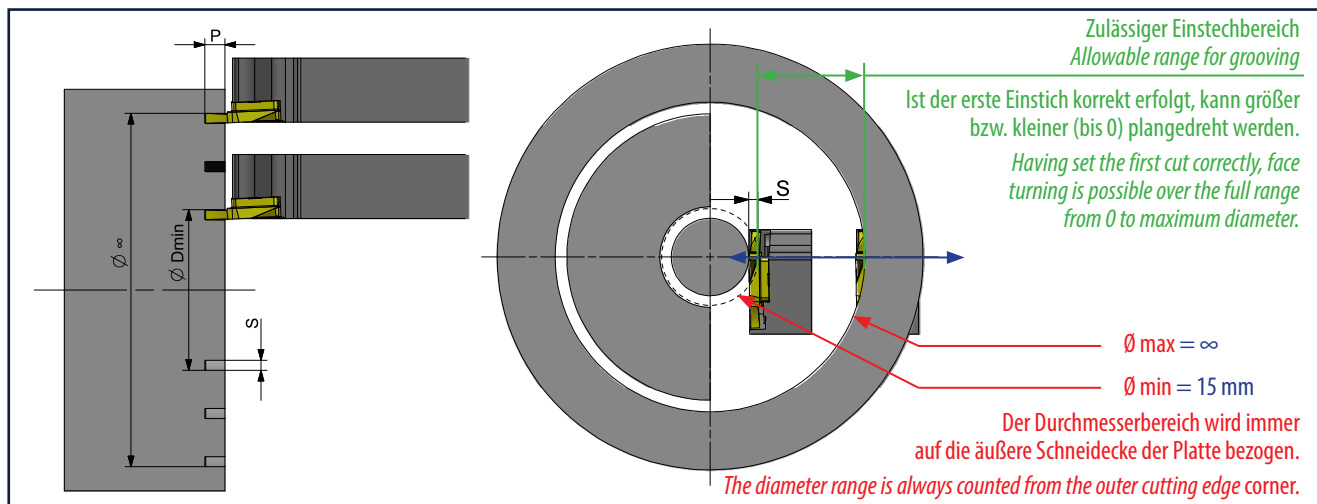

MULTICUT 4 | Stechplatten zum Ein- und Abstechen | Hartbearbeitung
Inserts for grooving and parting off | hard material machining

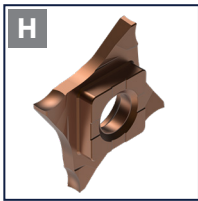

OFQ16L..N00

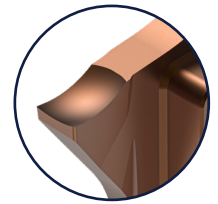
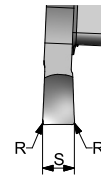
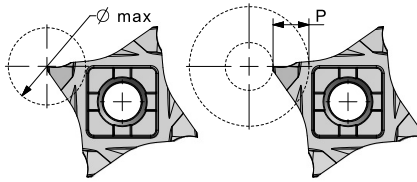

WG404 Bezeichnung Ref.	FM HARDSX3	Plattensitz- größe pocket size	()	P	R	s ^{+0,05}	Ømax.
	ID-Nr.						
OFQ16L 100 000 N 00	65335	16L	N	3,5	0,00	1,00	7,0
OFQ16L 120 000 N 00	65339	16L	N	6,5	0,00	1,20	13,0
OFQ16L 150 010 N 00	65341	16L	N	6,5	0,10	1,50	13,0
OFQ16L 200 010 N 00	65345	16L	N	6,5	0,10	2,00	13,0
OFQ16L 200 020 N 00	65346	16L	N	6,5	0,20	2,00	13,0
OFQ16L 250 010 N 00	65349	16L	N	6,5	0,10	2,50	13,0
OFQ16L 250 020 N 00	65350	16L	N	6,5	0,20	2,50	13,0
OFQ16L 300 010 N 00	65353	16L	N	6,5	0,10	3,00	13,0
OFQ16L 300 020 N 00	65354	16L	N	6,5	0,20	3,00	13,0

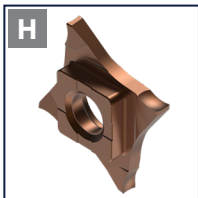

OFQ16R..N00

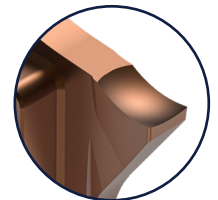
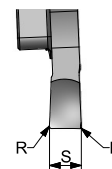
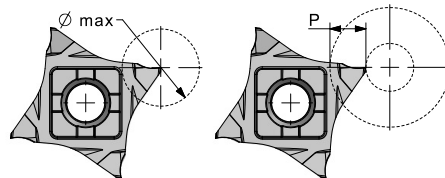

WG404 Bezeichnung Ref.	FM HARDSX3	Plattensitz- größe pocket size	()	P	R	s ^{+0,05}	Ømax.
	ID-Nr.						
OFQ16R 100 000 N 00	65362	16R	N	3,5	0,00	1,00	7,0
OFQ16R 120 000 N 00	65366	16R	N	6,5	0,00	1,20	13,0
OFQ16R 150 010 N 00	65368	16R	N	6,5	0,10	1,50	13,0
OFQ16R 200 010 N 00	65372	16R	N	6,5	0,10	2,00	13,0
OFQ16R 200 020 N 00	65373	16R	N	6,5	0,20	2,00	13,0
OFQ16R 250 010 N 00	65384	16R	N	6,5	0,10	2,50	13,0
OFQ16R 250 020 N 00	65385	16R	N	6,5	0,20	2,50	13,0
OFQ16R 300 010 N 00	65388	16R	N	6,5	0,10	3,00	13,0
OFQ16R 300 020 N 00	65389	16R	N	6,5	0,20	3,00	13,0

Passende Werkzeuge

GripLock Katalog 2020 | *GripLock catalogue 2020*



S. 43 44

S. 45

S. 45

193

MULTICUT 4 | Vollradiusplatten zum Einstechen und Kopieren | Hartbearbeitung
Full radius inserts for grooving and copying | hard material machining



OFQ16L..R..N

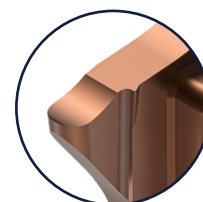
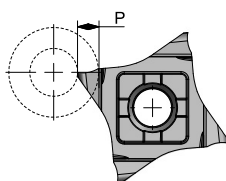

WG404 Bezeichnung Ref.	FM HARDSX3 ID-Nr.	Plattensitzgröße pocket size	⌀	P	R	S ^{+0,05}
OFQ16L 100 R050 N	65337	16L	N	1,0	0,50	1,00
OFQ16L 150 R075 N	65342	16L	N	1,5	0,75	1,50
OFQ16L 200 R100 N	65347	16L	N	2,0	1,00	2,00
OFQ16L 250 R125 N	65351	16L	N	2,5	1,25	2,50
OFQ16L 300 R150 N	65355	16L	N	3,0	1,50	3,00

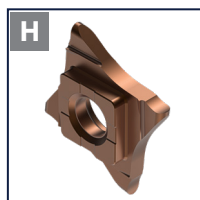

OFQ16R..R..N

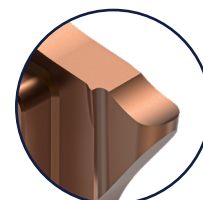
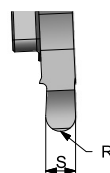
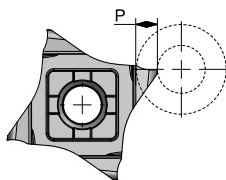

WG404 Bezeichnung Ref.	FM HARDSX3 ID-Nr.	Plattensitzgröße pocket size	⌀	P	R	S ^{+0,05}
OFQ16R 100 R050 N	65364	16R	N	1,0	0,50	1,00
OFQ16R 150 R075 N	65369	16R	N	1,5	0,75	1,50
OFQ16R 200 R100 N	65382	16R	N	2,0	1,00	2,00
OFQ16R 250 R125 N	65386	16R	N	2,5	1,25	2,50
OFQ16R 300 R150 N	65390	16R	N	3,0	1,50	3,00

Segmentierter und präzisionsgeschliffener
Schneidkörper aus Feinkornhartmetall.

*Segmented and ground micrograin insert.
Horizontal cutting edge and positive top rake.*

Passende Werkzeuge

GripLock Katalog 2020 | *GripLock catalogue 2020*



S. 43 44



S. 45



S. 45



193

MULTICUT 4 | Präzi-Einstechplatten für Einstiche nach DIN 471 | Hartbearbeitung
Precision grooving inserts according to DIN 471 | hard material machining



OFQ16L..N

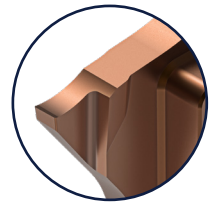
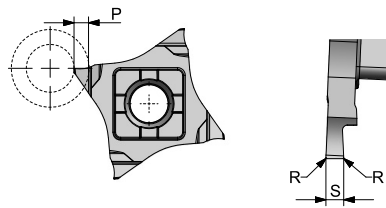

WG404 Bezeichnung Ref.	FM HARDSX3 ID-Nr.	Plattensitz- größe pocket size	(C)	P	R		S ^{-0,05}
OFQ16L 050 000 N	65330	16L	N	1,0	0,00	0,50	0,57
OFQ16L 060 000 N	65331	16L	N	1,0	0,00	0,60	0,67
OFQ16L 070 000 N	65332	16L	N	1,5	0,00	0,70	0,77
OFQ16L 080 000 N	65333	16L	N	1,5	0,00	0,80	0,87
OFQ16L 090 000 N	65334	16L	N	1,5	0,00	0,90	0,97
OFQ16L 100 000 N	65336	16L	N	1,5	0,00	1,00	1,07
OFQ16L 110 010 N	65338	16L	N	1,5	0,10	1,10	1,24
OFQ16L 130 010 N	65340	16L	N	1,5	0,10	1,30	1,44
OFQ16L 160 010 N	65343	16L	N	2,0	0,10	1,60	1,74
OFQ16L 185 010 N	65344	16L	N	2,0	0,10	1,85	1,99
OFQ16L 215 010 N	65348	16L	N	2,5	0,10	2,15	2,29
OFQ16L 265 010 N	65352	16L	N	2,5	0,10	2,65	2,79
OFQ16L 315 010 N	65356	16L	N	2,5	0,10	3,15	3,29



OFQ16R..N

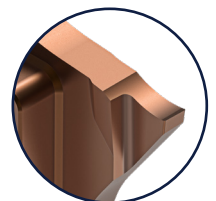
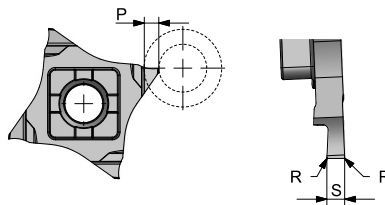

WG404 Bezeichnung Ref.	FM HARDSX3 ID-Nr.	Plattensitz- größe pocket size	(C)	P	R		S ^{-0,05}
OFQ16R 050 000 N	65357	16R	N	1,0	0,00	0,50	0,57
OFQ16R 060 000 N	65358	16R	N	1,0	0,00	0,60	0,67
OFQ16R 070 000 N	65359	16R	N	1,5	0,00	0,70	0,77
OFQ16R 080 000 N	65360	16R	N	1,5	0,00	0,80	0,87
OFQ16R 090 000 N	65361	16R	N	1,5	0,00	0,90	0,97
OFQ16R 100 000 N	65363	16R	N	1,5	0,00	1,00	1,07
OFQ16R 110 010 N	65365	16R	N	1,5	0,10	1,10	1,24
OFQ16R 130 010 N	65367	16R	N	1,5	0,10	1,30	1,44
OFQ16R 160 010 N	65370	16R	N	2,0	0,10	1,60	1,74
OFQ16R 185 010 N	65371	16R	N	2,0	0,10	1,85	1,99
OFQ16R 215 010 N	65383	16R	N	2,5	0,10	2,15	2,29
OFQ16R 265 010 N	65387	16R	N	2,5	0,10	2,65	2,79
OFQ16R 315 010 N	65391	16R	N	2,5	0,10	3,15	3,29

Passende Werkzeuge

GripLock Katalog 2020 | GripLock catalogue 2020



S. 43 44



S. 45



S. 45



193

MULTICUT 4 | ISO - und Whitworth Vollprofil - Gewindeplatten | Hartbearbeitung
ISO - & Whitworth full profile threading inserts | hard material machining



OFQ16R..ER

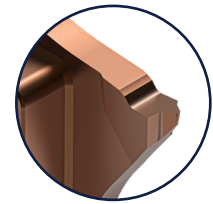
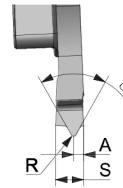
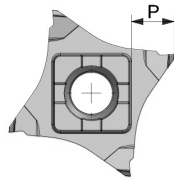

WG404 Bezeichnung Ref.	FM HARDSX3 ID-Nr.	Plattensitz- größe pocket size	(C)		A	R	P	S	α°
OFQ16R 200 050 ER ISO	65374	16R	R	0,50	0,5	0,07	6,5	2,0	60
OFQ16R 200 070 ER ISO	65375	16R	R	0,70	0,5	0,10	6,5	2,0	60
OFQ16R 200 075 ER ISO	65376	16R	R	0,75	0,5	0,11	6,5	2,0	60
OFQ16R 200 080 ER ISO	65377	16R	R	0,80	0,7	0,12	6,5	2,0	60
OFQ16R 200 100 ER ISO	65378	16R	R	1,00	0,7	0,15	6,5	2,0	60
OFQ16R 200 125 ER ISO	65379	16R	R	1,25	0,7	0,18	6,5	2,0	60
OFQ16R 200 28W ER	65381	16R	R	28 G/Zoll	1,0	0,12	6,5	2,0	55
OFQ16R 200 19W ER	65380	16R	R	19 G/Zoll	1,0	0,18	6,5	2,0	55
OFQ16R 350 14W ER	65393	16R	R	14 G/Zoll	1,3	0,25	6,5	3,5	55
OFQ16R 350 11W ER	65392	16R	R	11 G/Zoll	1,5	0,32	6,5	3,5	55
OFQ16R 350 150 ER ISO	65394	16R	R	1,50	0,8	0,20	6,5	3,5	60
OFQ16R 350 175 ER ISO	65395	16R	R	1,75	0,9	0,25	6,5	3,5	60
OFQ16R 350 200 ER ISO	65396	16R	R	2,00	1,0	0,29	6,5	3,5	60
OFQ16R 350 250 ER ISO	65397	16R	R	2,50	1,3	0,36	6,5	3,5	60
OFQ16R 350 300 ER ISO	65398	16R	R	3,00	1,8	0,43	6,5	3,5	60

Linke Gewindeplatten auf Anfrage
LH inserts on request.

Passende Werkzeuge
GripLock Katalog 2020 | *GripLock catalogue 2020*



Standard Design | Schneideinsätze zum Abstechen und Nutdrehen
Inserts for parting off and grooving



ITN

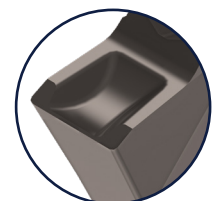
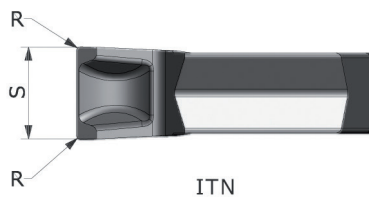

WG002 Bezeichnung Ref.	GF110 CARBOSX2 ID-Nr.	Plattensitzgröße pocket size	(C)	R	S $\pm 0,1$
ITN 2	65198	SD2	N	0,2	2,2
ITN 3	65199	SD3	N	0,2	3,1
ITN 4	65200	SD4	N	0,2	4,1
ITN 5	65201	SD5	N	0,2	5,1

IT Geometrie

Geschliffene Fase. Besonders geeignet für legierte Stähle und unterbrochene Schnitte.

IT Geometry

Ground chamfer. Recommended for alloyed steels and interrupted cuts.

Passende Werkzeuge
GripLock Katalog 2020 | *GripLock catalogue 2020*



FLEX FIX | Schneideinsätze zum Abstechen und Nutdrehen
Inserts for parting off and grooving



IFN

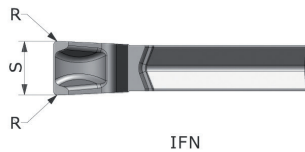

IFN

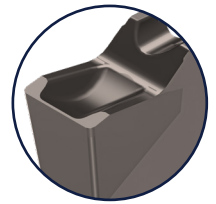

WG0022 Bezeichnung Ref.	KM CARBOSX2 ID-Nr.	KS140 CARBOSX2 ID-Nr.	Plattensitzgröße pocket size	()	R	S ±0,05
IFN 2	65195		FF2	N	0,2	2,0
IFN 3	65196	65430	FF3	N	0,2	3,0
IFN 4	65197		FF4	N	0,2	4,0

IF Geometrie hat eine **geschliffene Fase** und eignet sich besonders für:

- Legierte Stähle
- Unterbrochene Schnitte

IF Geometry with its cutting edge strengthening, ground chamfer is recommended for:

- Alloyed steels
- Interrupted cuts

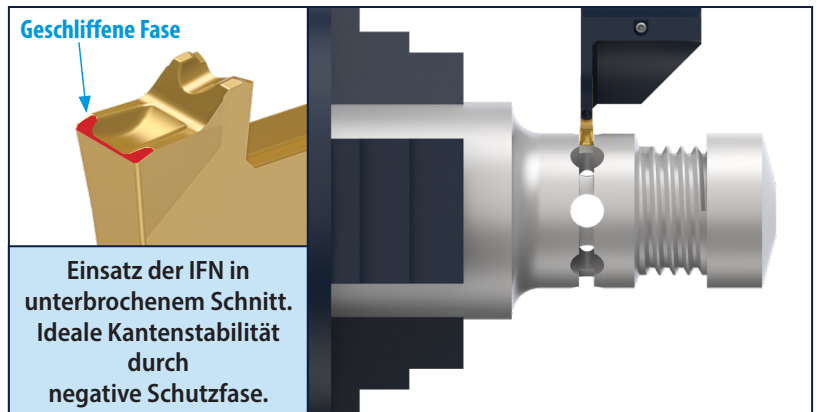

SFN

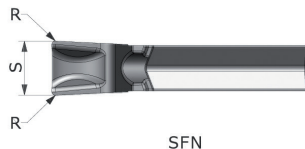

SFN

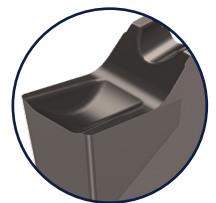

WG0022 Bezeichnung Ref.	KM CARBOSX2 ID-Nr.	KS140 CARBOSX2 ID-Nr.	Plattensitzgröße pocket size	()	R	R	S ±0,05
SFN 2	65255		FF2	N	0,2	0,2	2,0
SFN 3	65256	65431	FF3	N	0,2	0,2	3,0
SFN 4	65257		FF4	N	0,2	0,2	4,0

SF-Geometrie SUPERNOVA

Die bogenförmige Schneide mit verstärkten Flanken sickt die Späne stark ein und kann so ideale Spanbrüche erzeugen. Besonders geeignet für Automatenstähle und niedrig legierte Stähle bei antriebschwachen und instabilen Maschinenbedingungen.

SF-Geometry SUPERNOVA

The arc shaped cutting edge with its reinforced flanks achieves ideal chips. Recommended for free cutting and low alloyed steels, also to be used on unstable machine tools.

Passende Werkzeuge

GripLock Katalog 2020 | *GripLock catalogue 2020*



Ausblick | *Coming soon*

AMB
Internationale Ausstellung
für Metallbearbeitung
10. - 14.09.2024
Messe Stuttgart



Specialist for
Special tools



SAVE THE DATE!
Halle 1 Stand A02



Der neue GripLock
Katalog 2024/2025
kommt!

*Our new main catalogue
2024/2025 is coming!*

Erleben Sie weitere
Produckthighlights
und Erweiterungen!

*Experience more new
highlights and
expansions!*

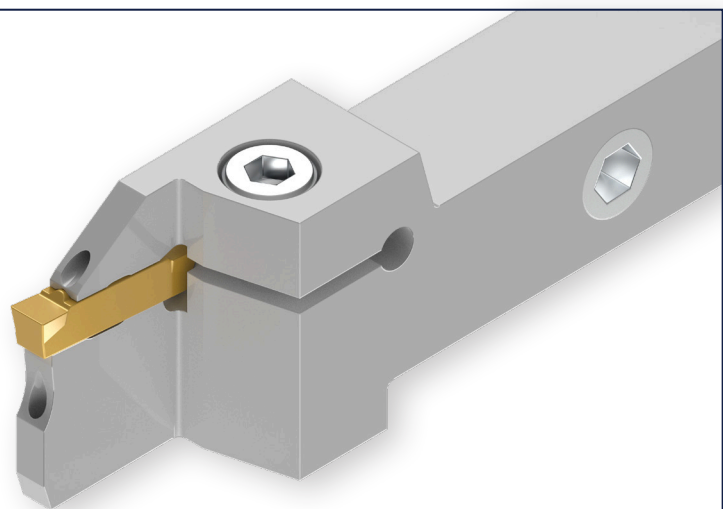



1974 - 2024

50 Jahre Erfahrung im Stechen & Stechdrehen
50 years of experience in grooving solutions



Kemmer Hartmetallwerkzeuge wurde 1974 in Wildberg im Schwarzwald gegründet. Der Standort fand 1998 im fertiggestellten, modernen Verwaltungsgebäude seinen Höhepunkt. Von dort gehen GripLock Werkzeuge zügig und zuverlässig „in alle Welt“.

Kemmer Hartmetallwerkzeuge was founded in 1974 in Wildberg in the Blackforest. In 1998 the Administration Department was moved to the completed modern administration building. From this location GripLock tools are rapidly and reliable sent to "all over the world".



Seit 1993 fertigen und entwickeln wir am Produktionsstandort in Zella-Mehlis Werkzeuglösungen für den Stech- und Stechdrehbereich, sowie kundenspezifische Sonderwerkzeuge. 2023 feierte unsere Produktion 30-jähriges Standortjubiläum!

Since 1993 our tools for grooving, side turning and parting off applications as well as tailor made solutions are produced and developed in our plant site in Zella-Mehlis. Here we provide also trainings for our customers. In 2023 we've celebrated 30 years of Kemmer in Zella-Mehlis!

