

GRIPLock[®]

Catalogue 2020

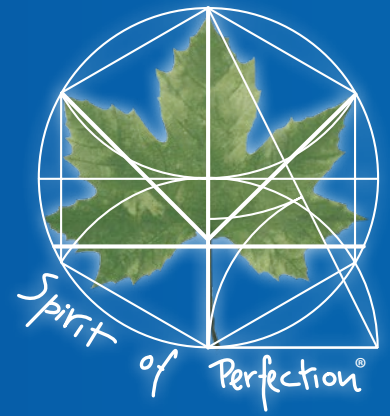

SFN

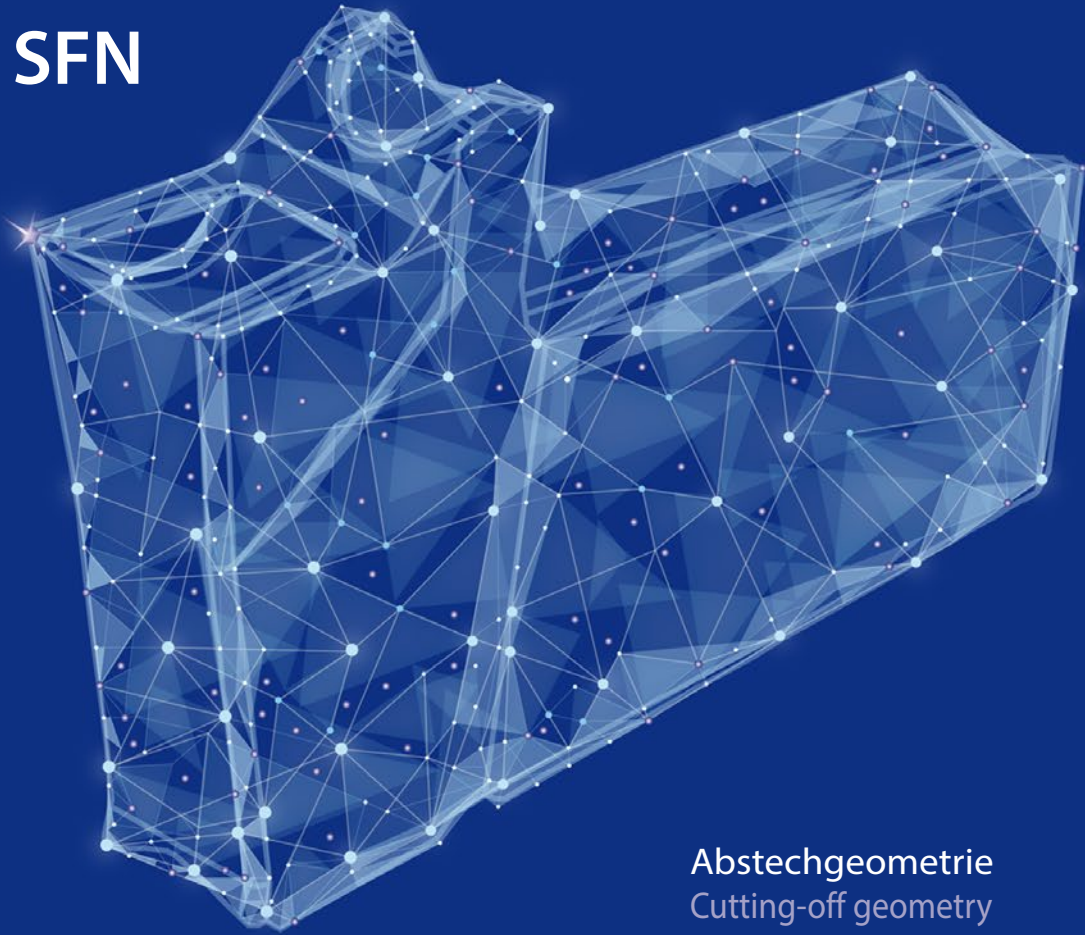



Abstechgeometrie
Cutting-off geometry



System Overview



p. 14

M92 Q – MULTICUT 4 | Grooving, parting off, threading, precision grooving, full radius grooving, hard material machining , internal cooling 

p. 25

GLRM92 MULTICUT | Circular milling

p. 47

P92 | Grooving, grooving and turning off, parting off, hard material machining , internal cooling 

p. 55

P92 2 and P92 90 | Face grooving

p. 109

P92 P | Precision grooving

p. 123

P92 S | Grooving, grooving and turning, parting off, threading, hard material working 

p. 141

One edge systems | Grooving, parting off, Internal cooling 

p. 157

GLM – GripLock Modular | Quick change tool system, internal cooling 

p. 185

F92 - Profil cutting

p. 203

Tailor made solutions

p. 207

Individual internal cooling with different connections 

p. 215

Spare parts and accessories

p. 224

Technical section, Explanations, product index

p. 229

1974 2020

History of the company

Klaus and Raimund Kemmer are proud of the 46 years of the company's history and its loyal companions throughout this period of time.

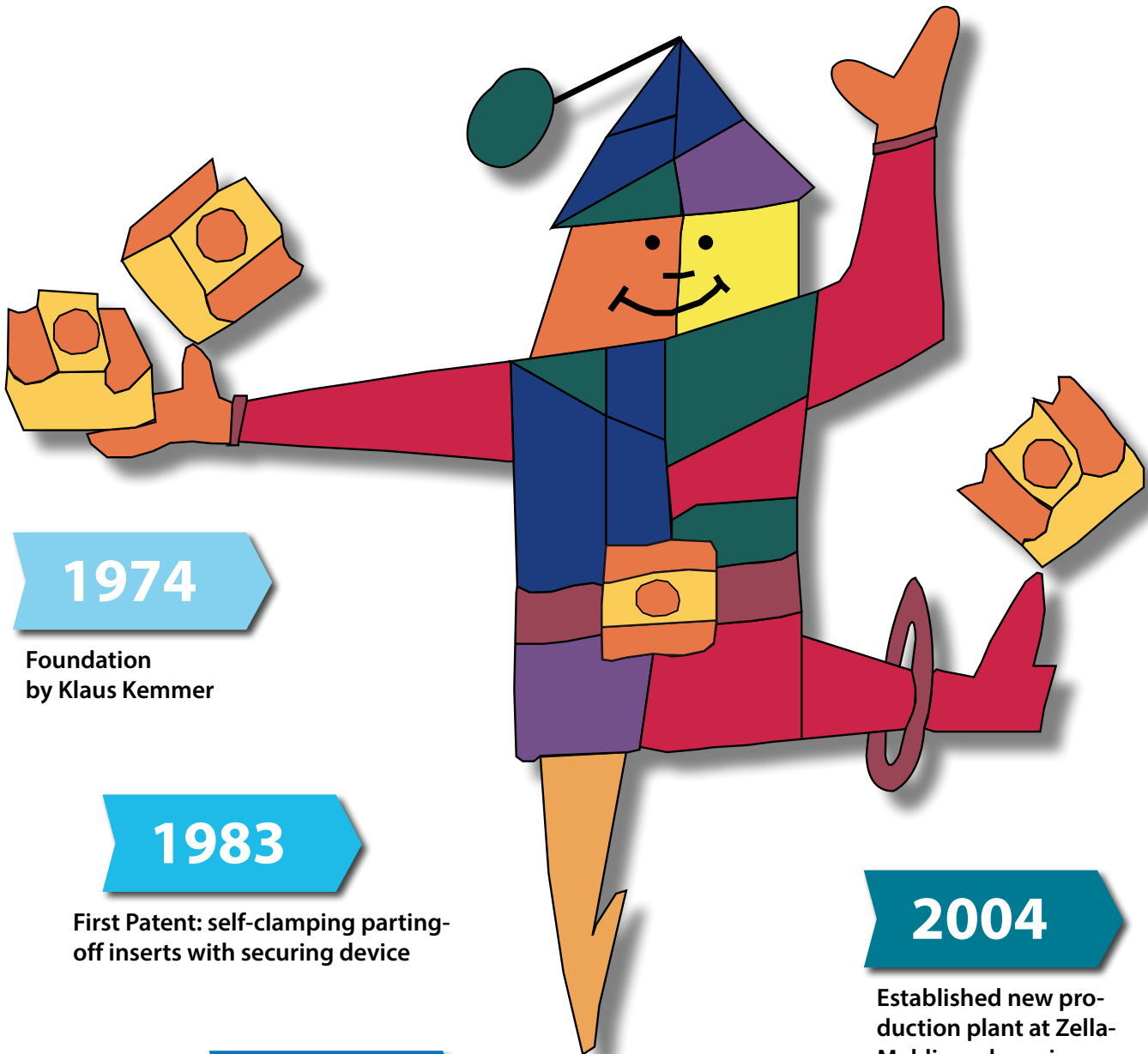

1974

Foundation
by Klaus Kemmer

1983

First Patent: self-clamping parting-
off inserts with securing device

1993

Taking over the Südthüringer
Präzisionsgewindewerkzeugfabrik
company and starting production
at Zella-Mehlis

1997

Established new administ-
ration building at Wildberg

2004

Established new pro-
duction plant at Zella-
Mehlis and moving
into the new site

1974 2020

More than 45 years, the Kemmer company is running as family business. Klaus Kemmer and Raimund Kemmer as General Managers together with an excellent staff are continuously developing and designing the unique GripLock System. The unique GripLock System includes systems for parting-off, precision grooving, face grooving, profile form cutting, GripLock Modular Quick-Change system and a variety of special tooling. Very specialties are cutting and turning and threading.



2009

First Certification



2016

Granted Trade Mark:
"Spirit of Perfection"

2017

Presentation vehicle
"Goldjoker" on tour visit-
ing business partners

2009

Developing a new product line
"Twin Plate" and "GripLock
Modular". Patent granted for
"FlexFix" inserts

2007

Patent granted for
Multicut 4 inserts.
Developing Monoblock
Axial System.

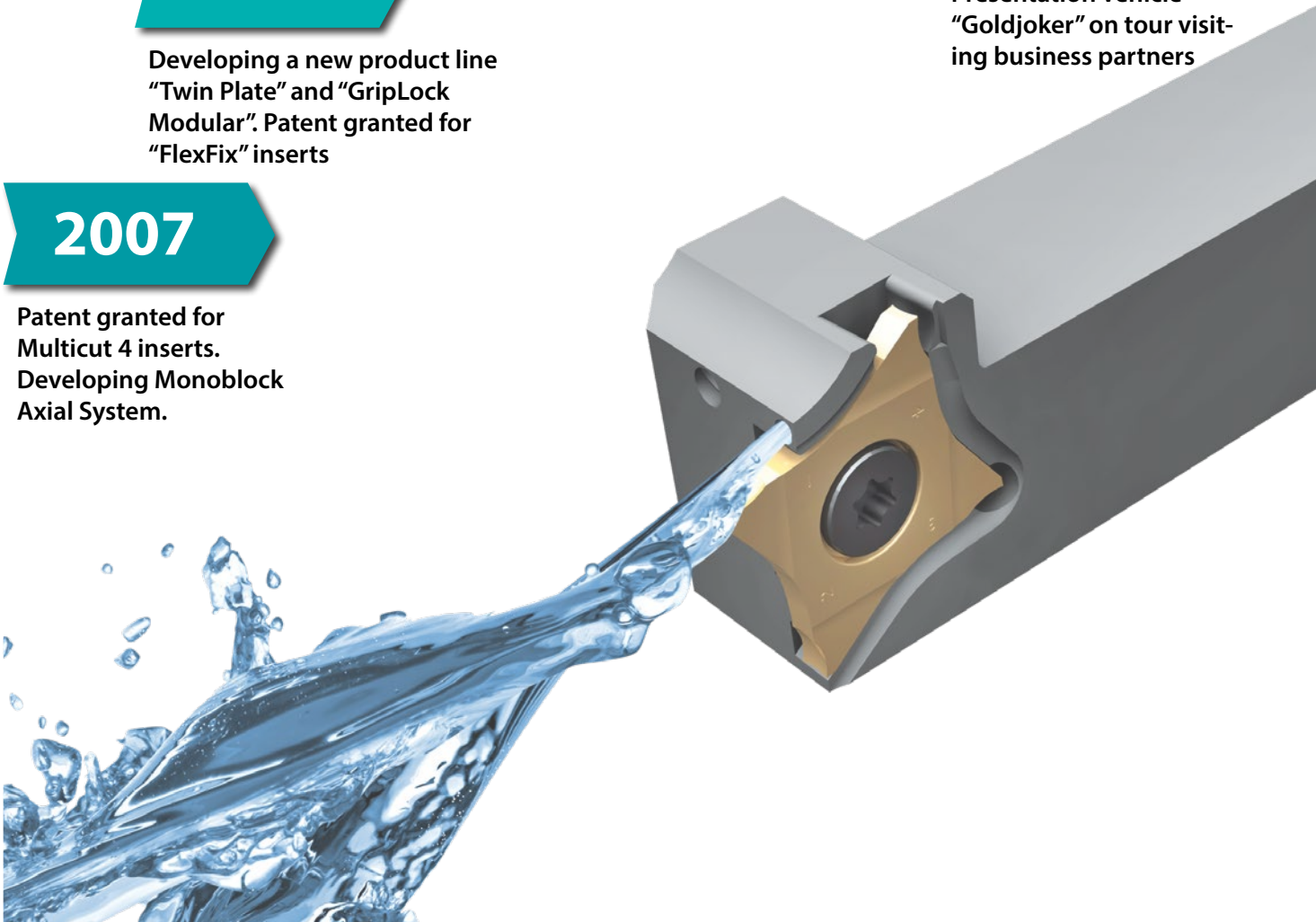

Trademark "Spirit of Perfection"

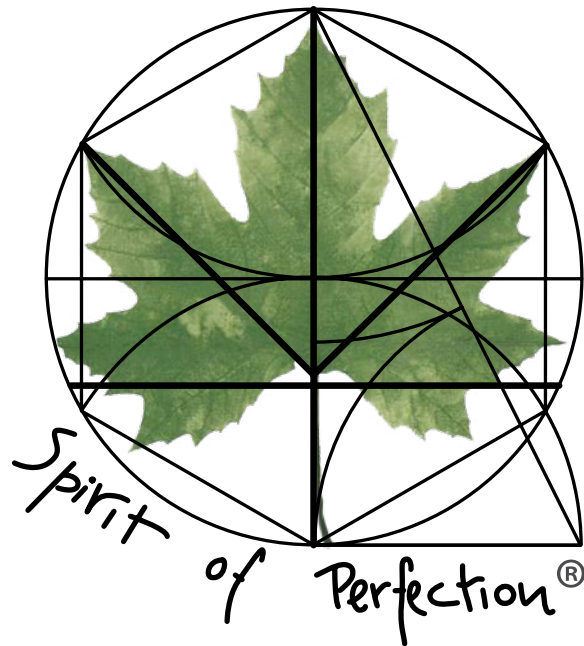

TRADEMARK AND LOGO
ARE SHOWING OUR DEDICATION
TO PERFECTION.

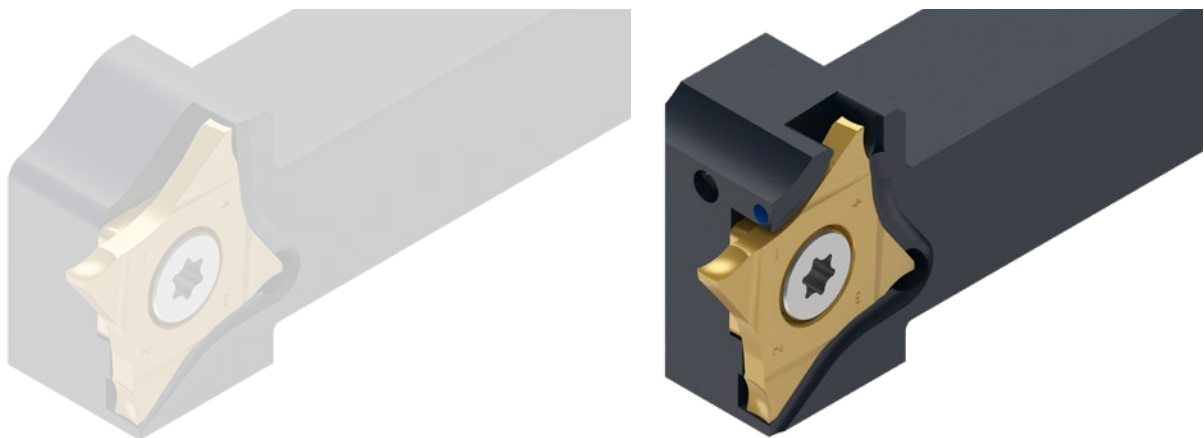

System Overview

page 3

Introduction

	page
▶ Our goal	11
▶ Cost controlling	12
▶ Important characteristics for a good result	13

Product overview

page 14

Parting off

4-edges	Starting page	
▶ Inserts	29	
▶ Holders	43	
▶ Blades	45	
2-edges		
▶ Inserts	74, 143	
▶ Holders	88, 152	
▶ Blades	101, 153	
1-edge		
▶ Inserts	160, 170, 176	
▶ Holders	163, 172, 179	
▶ Blades	166, 173, 181	

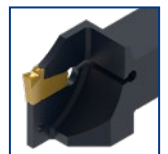

Cutting and turning

4-edges	Starting page	
▶ Inserts	29	
▶ Holders	43	
▶ Blades	45	
2-edges		
▶ Inserts	61, 125, 145	
▶ Holders	88, 133, 152	
▶ Boring bars	106, 135, 153	
1-edge		
▶ Inserts	107, 138, 154	
▶ Boring bars	108, 139, 155	

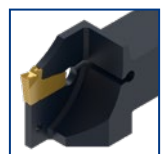

Thread machining

4-edges Starting page

- ▶ Inserts 35
- ▶ Holders 43
- ▶ Blades 45

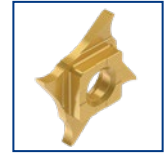

2-edges

- ▶ Inserts 131, 146
- ▶ Holders/blades 133, 152
- ▶ Boring bars 135, 153

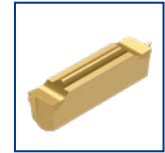

1-edge

- ▶ Inserts 139, 154
- ▶ Boring bars 139, 155

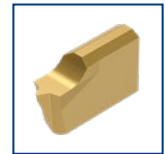

Circular milling

4-edges Starting page

- ▶ Inserts 49
- ▶ Shaft mills 53
- ▶ Heads 54



Face grooving

2-edges Starting page

- ▶ Inserts 61
- ▶ Holders + cartridges 113
- ▶ Holder Monoblock 118
- ▶ Blades 121



1-edge

- ▶ Inserts 174
- ▶ Blades 175



GLM - GripLock Modular System

Starting page

- ▶ Basic tool holder 189
- ▶ Cartridges 193
- ▶ Tailor made solutions 200

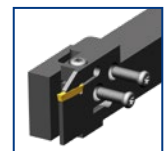

Profile cutting

- | | |
|-----------|------|
| | page |
| ▶ Inserts | 205 |
| ▶ Holders | 206 |



Tailor made solutions

page 207

Special solutions - when and why to be applied

page 208

Special inserts

page 209

Special tool holders

page 212



Hard material cutting

- | | |
|-------------------|---------------|
| | Starting page |
| ▶ 1-edge inserts | 108, 155 |
| ▶ 2-edges inserts | 83, 150 |
| ▶ 4-edges inserts | 39 |

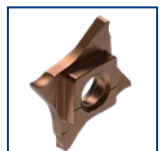
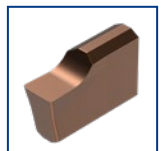

Internal cooling

	Starting page
▶ Introduction + Explanation	215
▶ Basic tool holder MC4	219
▶ Basic tool holder P92	219
▶ Basic tool holder P92A	220
▶ Basic tool holder F16	221



Spare parts and Accessories

	page
▶ Spare parts	224
▶ Torque wrench	226

Technical section

	page
▶ Symbols	230
▶ Abbreviations	230
▶ Selection of chip breaker	231
▶ List of available geometries for grooving, turning and parting off	232
▶ Selection of grades and speeds	234
▶ Selection of feeds	235
▶ Recommendations for parting off	236
▶ Hardness range of grades with principle recommendations	237
▶ Basics to select the right tools	238
▶ Tool application on the main and counter spindle	239
▶ Coatings	240
▶ Wear marks and tips	242
▶ Abrasion by cutting action	243
▶ Recommendation for cutting and turning	244
▶ Basics on threading	245
▶ Tool holder damages: cause, effect and solution	252
▶ Technical section GLRM MULTICUT circular milling	253
▶ Material comparison tables	254
▶ Product index	260

Informations about ISO-range, abbreviations and symbols please find at the inner part of the cover, on the back.



Our goal

To solve problems

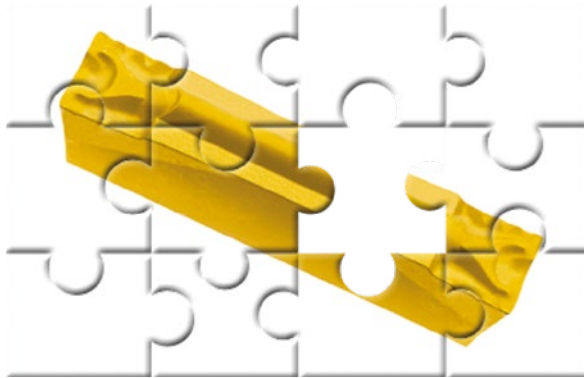

One must take into consideration the complexity of the work to be done. In order to manufacture a precise component, one needs aligned tools for each particular task. The varied selection of:

Tool holders, chipbreakers, cutting materials and coatings require a **great deal of „Know How“ of application technology**, in order to select the appropriate tool for the particular task.



Our skills



We have acquired a cast knowledge of application technology by means of continuous testing operations which enable us to do the analysis to provide a strong price performance ratio.



Our task and goal is ...



... to provide a strong price performance ratio in order to help you to solve the problem.

Cost controlling

- ▶ Cutting operations are far more expensive than turning or milling operations. For this reason the price performance ratio is essential.

Turning inserts



CNMG 1204
4 + 4 edges
~ 1 €/edge

Turning inserts



SNMG 1204
8 edges
~ 1 €/edge

Milling inserts



ODKT 1205
8 edges
~ 1 €/edge

Parting off inserts



ITN 4
1 edge
~ 9 €/edge

- ▶ The „perfect“ quality of insert grades is essential!
- ▶ It is one of our goals to provide the best possible price performance ratio and offer you the best service for your job.

The difficult way to the center

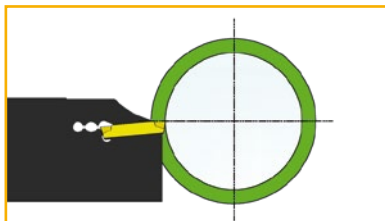

- ▶ The way towards the center isn't easy at all: When beginning the operation **all conditions are ideal**:
 - cutting speed (V_c)
 - cooling and
 - chip removal

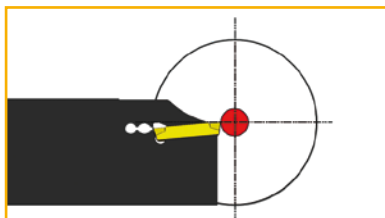

- ▶ The more the cutting edge arrives at the center the more conditions **deteriorate gradually**.
 - Cutting speed decreases to zero
 - cooling becomes inefficient
 - chip removal becomes very difficult.

- ▶ Parting off is a difficult and expensive operation. Therefore professional and **cash saving** applications are essential.

... an intelligent way to save a lot of money!!



Important characteristics for a good result

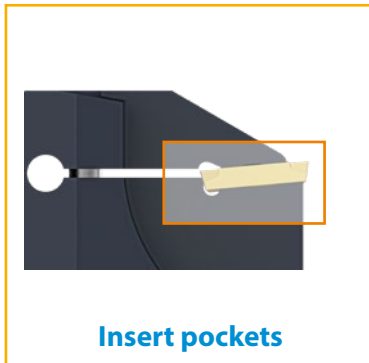

Insert pockets

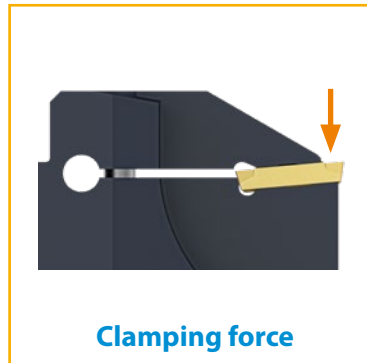

Clamping force

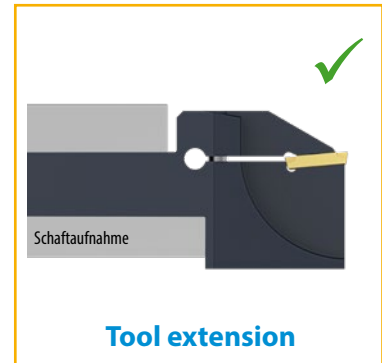

Tool extension

▶ Parting off:

The stronger the tool, the higher the gripping power, the better performance and result are, like:

- ✓ True and straight run
- ✓ Clean faces
- ✓ Plane parallel faces
- ✓ Tool life
- ✓ Perfect cooling

Premium tool choice:

Unique chip breaker

e.g.

- ▶ Cutting off geometry TWIN **BTNN**
- ▶ Cutting off geometry TWIN **SCTD**
- ▶ Stech-/Längsdrehgeometrie TWIN **MTNS**
- ▶ Cutting off geometry one edge **SFN**
- ▶ List of available geometrys page 232



Fitting tooling

e.g.

- ▶ TWIN blade **P92 TMS**
- ▶ Reinforced holder **P92 A CXCBL/L**
- ▶ Reinforced parting off blades **P92 CXCBL/L...X**
- ▶ Reinforced parting off blades **Flex Fix F16 R/L 65**
- ▶ High pressure cooling tools
- ▶ Product overview page 14



Typical weak points:

- ▶ Insufficient clamping force between tools and machine tool
- ▶ Insufficient clamping force between tool holders and inserts
- ▶ Insufficient chucking force

- ▶ **For parting off don't compromise!
Choose the tool with the best solidity.**



P92 A CXCBL

M92-System - MULTICUT 4 edges

Cutting inserts

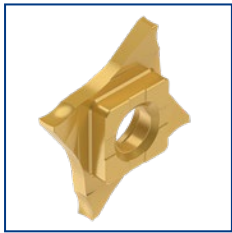

OFQ16R/L...N/R/L
p. 29 - 30

Part profile
threading insert

Precision cutting inserts

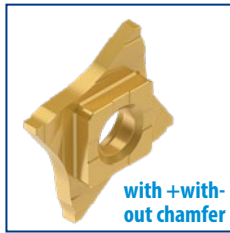

OFQ16R/L...N
p. 31

Inserts for hard
material machining

Axial-Stechplatten



OFQ16R/L...A
p. 33

Full radius inserts hard
material machining

Full radius inserts



OFQ16R/L...R...
p. 34

Precision inserts hard
material machining

Threading inserts

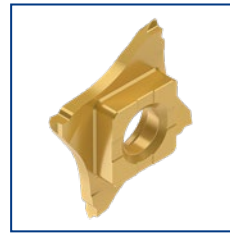

OFQ16R/L...EL
p. 35

Threading inserts hard
material machining

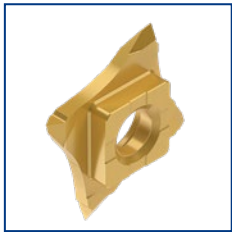

OFQ16R/L...EIR
p. 37

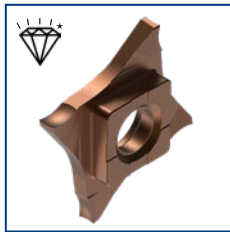

OFQ16 R/L...N00
p. 39

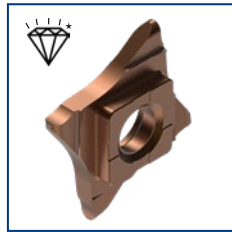

OFQ16R/L..R..N
p. 40

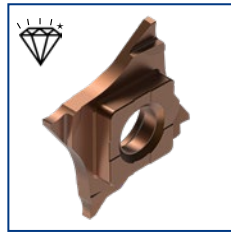

OFQ16 R/L...N
p. 41

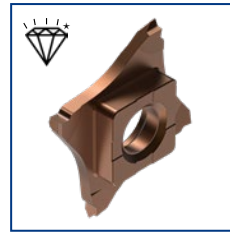

OFQ16R...ER
p. 42

Holder

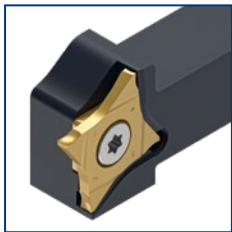

M92 Q FXCBR/L...K...
p. 43

Holder with internal cooling



M92Q...HP
p. 44

Holder for many different turning applications

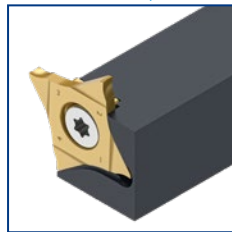

M92 Q 90FXCBR_L...
p. 45

Blades



M92 Q FXCBR/L...X...
p. 45

Cartridges

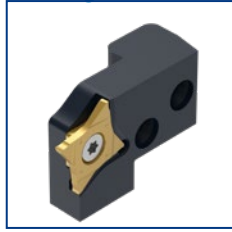

GLMC R/L M92 Q
p. 193

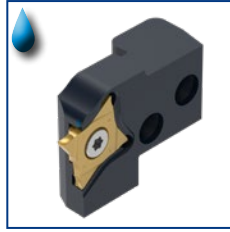

GLMCR/L M92 Q...HP
p. 193

GLRM92 MULTICUT Circular milling 4 edges

Inserts for shaft mills D28

Cutting inserts

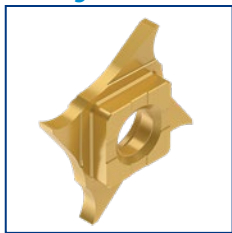

OFQ16L..P..S
p. 49

Full radius inserts



OFQ16L..R..P..S
p. 50

Precision cutting inserts



OFQ16L..P35S
p. 51

Precision cutting inserts

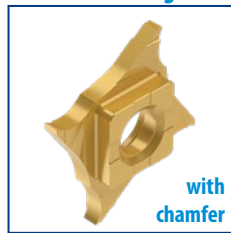

OFQ16L..P..S
p. 51

GLRM92 MULTICUT Circular milling **4 edges**

Cutting inserts for milling heads and shaft mills D 52-80

Milling heads and shaft mills



OFQ16L..P35S
p. 52

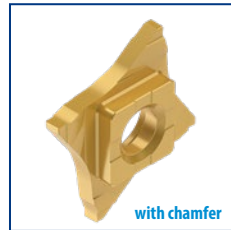

OFQ16L..P..S
p. 52

Shaft mill D28



GLRM92..28..SW
p. 53

Shaft mill D52



GLRM92..52..SW
p. 53

Milling head D52-80



GLRM92..M
p. 54

P92-System **2 edges**

Cutting and turning inserts



VTNS
p. 61



MTNS
p. 61



MTNSG
p. 62



STNZ / STNG
p. 63



CTDS
p. 63



ETNZ
p. 64



PTNSM
p. 65



MTNZ
p. 66



GTNS
p. 67



XTNS
p. 68



BTNG
p. 69



BTNX
p. 69

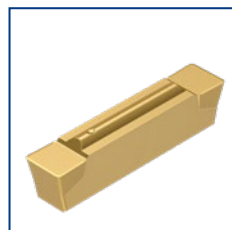

OTXC
p. 70

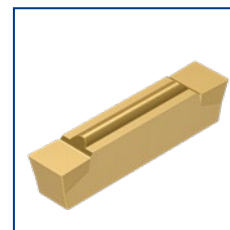

OTXS
p. 70



RTNG
p. 71



RTNX
p. 71

P92-System

2 edges

Parting off inserts

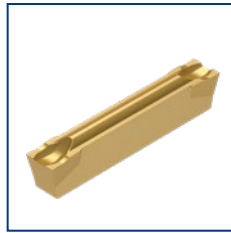
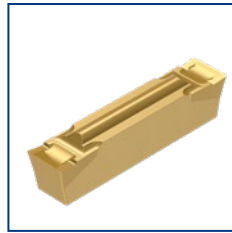
BTNN R/L
 p. 74 - 75

BTNNF
 p. 76

CTD ALU
 p. 77

CTD
 p. 78

SCTD
 p. 79

LTNN
 p. 80

Parting off inserts for large diameters

A GTNS
 p. 81

A BTNN
 p. 81

A CTD
 p. 81

A SCTD
 p. 82

Cutting and turning inserts for hard material machining

BTNG
 p. 84

MTNS
 p. 84

RTNG
 p. 85

Cutting and grooving inserts for hard machining

BTNN
 p. 85

CTD ALU
 p. 86

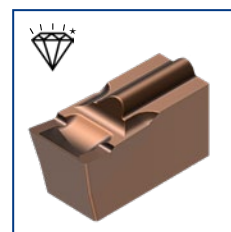
SCTD
 p. 86

KCTD
 p. 87

P92-System **2 edges**

Holders, boring bars, Cartridges and blades for cutting, grooving and turning

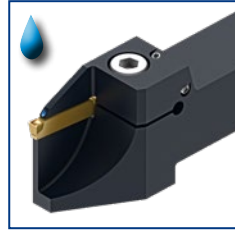

P92 CXCBL/L...
p. 88 - 93



P92 CXCBL/L HP
p. 94

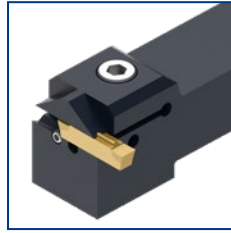

P92 90 UNI
p. 95

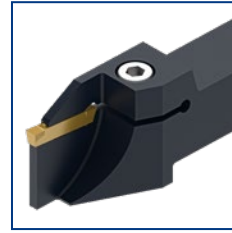

P92 A CXCBL/L...D42-56
p. 96

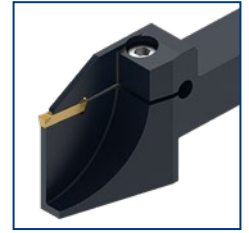

P92 A CXCBL/L...D65-80
p. 97

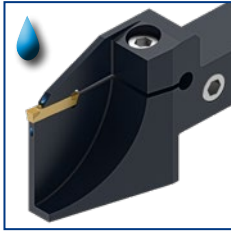

P92 A CXCBL HP
p. 98

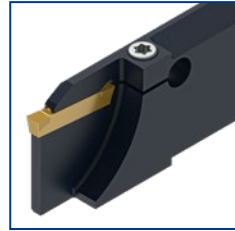

P92 CXCBL/L...R/L
p. 101



P92 A CXCBL HP
p. 102

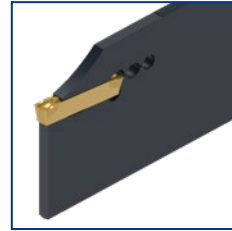

P92 TMS
p. 103

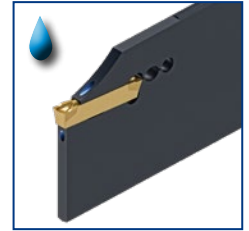

P92 TMS HP
p. 104

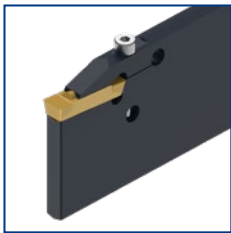

P92 TMS 52
p. 104



P92 CTR...HHPG1/8
p. 105



P92 CT HP
p. 105



P92 CGR/L
p. 106

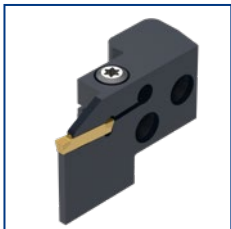

GLMCR/L P92
p. 194

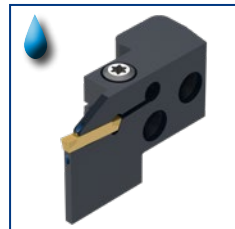

GLMCR/L P92 HP
p. 194

P92-System **1 edge**

Small boring bars and inserts for cutting, grooving and turning

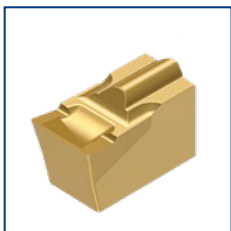

KCTD
p. 107



KCTDS
p. 107



KCTD
p. 108

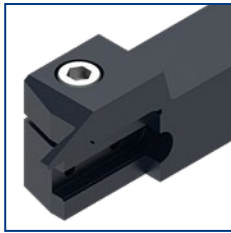
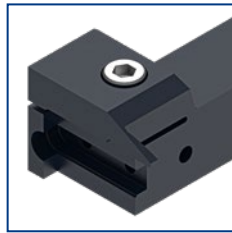
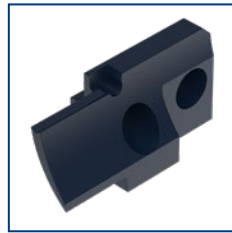
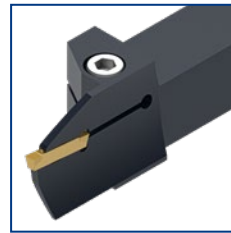

P92 CGR/L..30C
p. 108

P92 2 and P92 90
2 edges
Holder with cartridges for face grooving and -turning

P92 2 CXCRD/LD
p. 113

P92 90 CXCRD/LD
p. 115 + 116

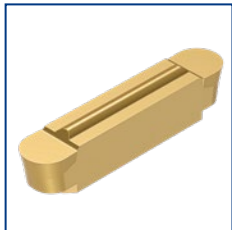
C92 LD/RD
p. 115 + 116

P92 2 CXCBRL/L
p. 118 - 120
Monoblock holder for face grooving & -turning
Blades for face grooving

P92 2 TMS
p. 121
P92 P-System
2 edges
Precision inserts

OTX...R/L
p. 125

OTXR...R/L
p. 126

OTXR...N
p. 127

OTXR...N R
p. 127
Precision inserts for longitudinal turning

STV R/L
p. 128

STD R/L
p. 129

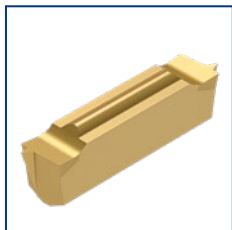
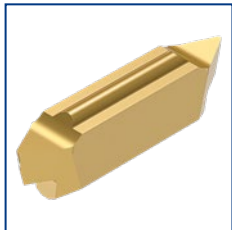
OTX DECO (Decolletage)
p. 130
ISO-threading inserts (internal and external)

OTX ER Full profile
p. 131

OTX IR Full profile
p. 131

OTX EIR Part profile
p. 132

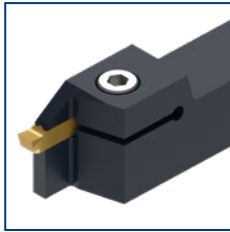
P92 P-System 2 edges

Precision holders, -boring bars and -cartridges for OTX inserts



P92 P CXCBR/L
p. 133



P92 P CXCBR/L..K4 11
p. 134



P92 P CGR/L
p. 135

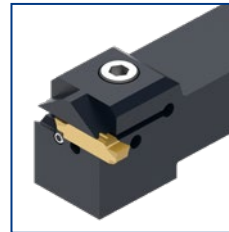

P92 P 90 uni
p. 136

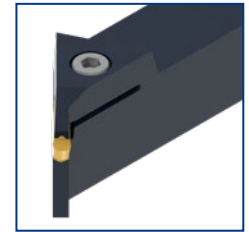

P92 P 45 CXCBR/L
p. 137

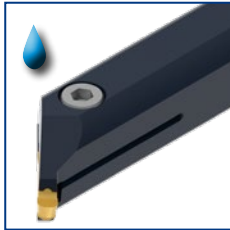

P92 P 45 CGR
p. 137

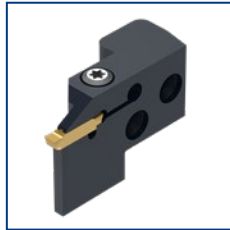

GLMCR/L P92 P
S. 195

P92 P-System 1 edge

Precision grooving and ISO threading inserts for internal machining

Fitting boring bars

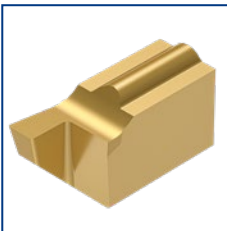

KOTX...R/L
p. 138

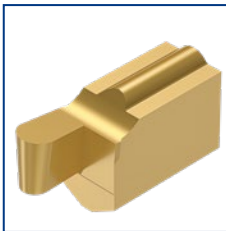

KOTX R...R/L
p. 138

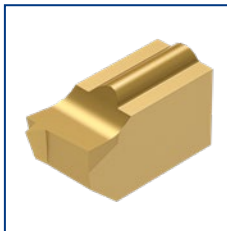

KOTX 4 IR Vollprofil
p. 139



P92 P CGR...4C
p. 139

P92 S-System (2 mm cutting width) 2 edges

Inserts for parting off and small ISO-threading inserts



BTNS
p. 143



ITNS
p. 143

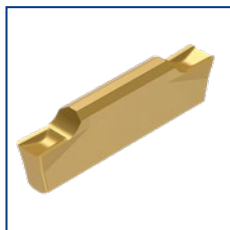

STNS
p. 144

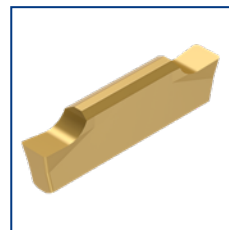

HTNS
p. 144



HTNST
p. 145

Cutting inserts for hard material machining



HTNG 2 ER / IR
p. 146-147



ITNS
p. 150

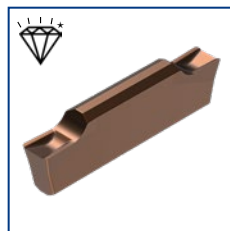

STNS
p. 150

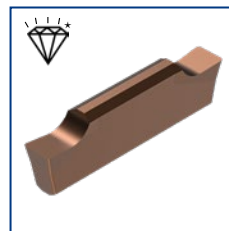

HTNS
p. 150

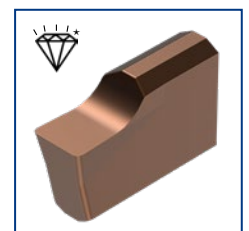

KHTNS
p. 151

P92 S-System (2 mm cutting width)
2 edges

Holders, blades and boring bars for cutting, grooving, turning and threading

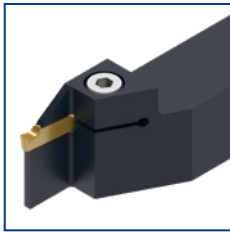
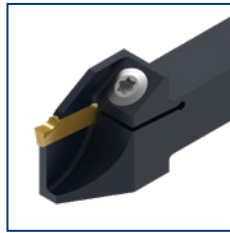

P92 S CXCBR/L
 p. 152

P92 S CXCBR/L..11
 p. 152

P92 S CXCBR/L...X
 p. 153

P92 S CGR/L
 p. 153

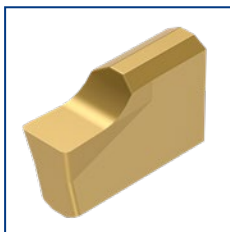
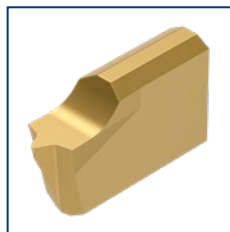
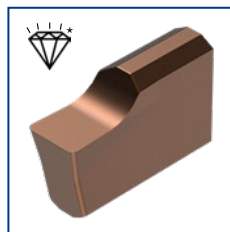
P92 S-System
1 edge

Inserts for cutting and threading



KHTNS 2
 p. 154

KHTNG 2 IR
 p. 154

KHTNS
 p. 155

fitting boring bars

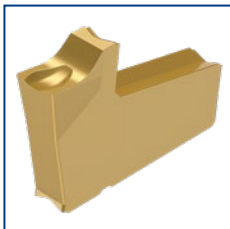
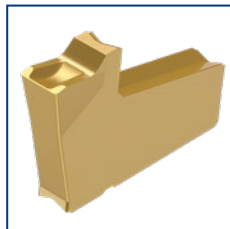
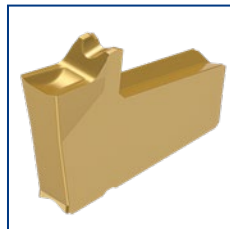
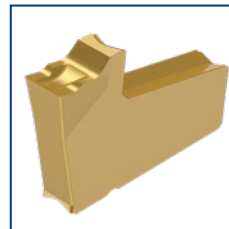

P92 S CGR/L M20C
 p. 155

FLEX FIX - System
1 edge

Parting off inserts

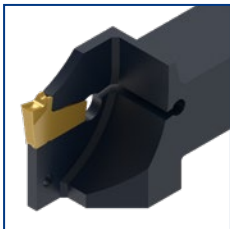
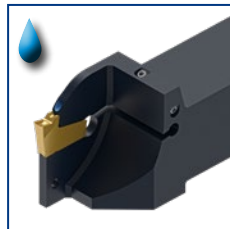
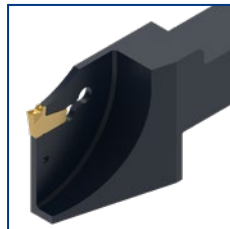

BFN
 p. 160

IFN
 p. 161

SFN
 p. 162

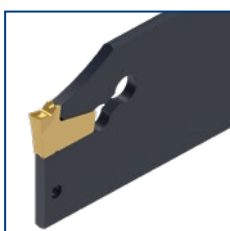
IFN ALU
 p. 162

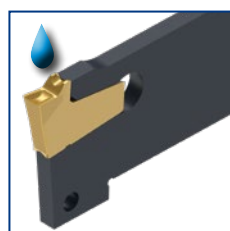
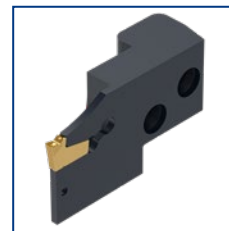
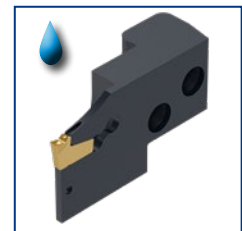
Holders, blades and cartridges for parting off

F16 R/L 42
 p. 163

F16 R/L 42 HP
 p. 163

F16 R/L 65
 p. 164

F16 R/L 65 HP
 p. 164

F16 R/L
 p. 165

F16 T
 p. 166

F16 T HP
 p. 166

F16 PM
 p. 167

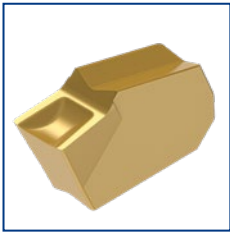
GLMCR/L F16
 p. 195

GLMCR/L F16 HP
 p. 196

passt perfekt-System (ground top guide) 1 edge

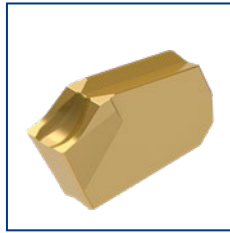
Parting off inserts



SNP
p. 170



BGP R/L
p. 171

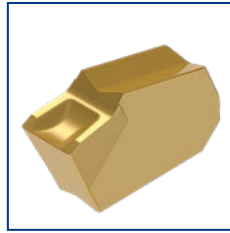

ITP
p. 171

HOLDERS and blades for parting off

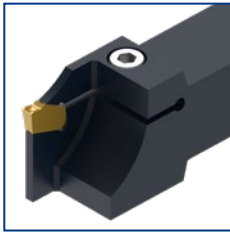

CLPP R/L
p. 172

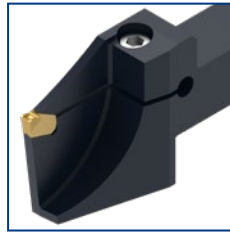

CLPP R/L...X65
p. 173

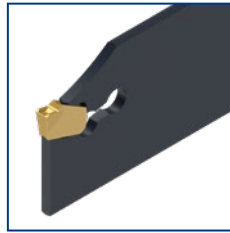

TMSPP
p. 173

Inserts and blades for face grooving and turning



PPTNR/L
p. 174



PPSMSR/L
p. 175

Standard Design-System (precision sintered) 1 edge

Parting off inserts



SNTN/R/L
p. 176



ITN/R/L
p. 177

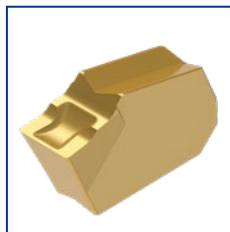

ITN/R/L ALU
p. 178



BGN/R/L
p. 178

HOLDERS and blades for parting off

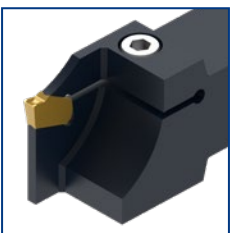

CLCBR/L
p. 179

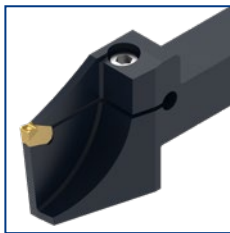

CLCBR/L...X
p. 180

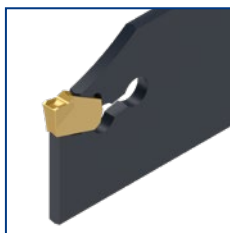

TMS
p. 181

Tool blocks



TS
p. 182

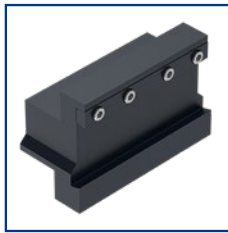

KL 52
p. 183

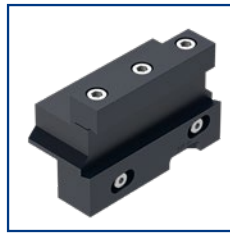

KLV
p. 183

GLM - GripLock Modular System

Basic tool holders

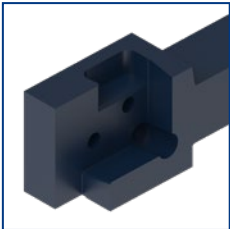

GLM HR/L
p. 189



GLM PSC..R/L 0
p. 190



GLM PSC..R/L 90
p. 190



GLM HSK63T..R/L 0
p. 191



GLM HSK63T..R/L 10
p. 191



GLM HSK63T..R/L 45
p. 191



GLM HSK63T..R/L 90
p. 192

GLM - GripLock Modular System

Cartridges

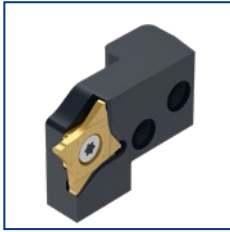

GLMC R/L M92 Q
p. 193

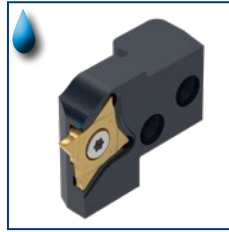

GLMCR/L M92 Q...HP
p. 193

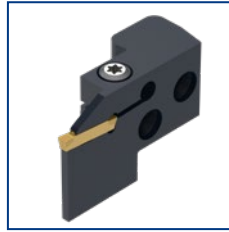

GLMCR/L P92
p. 194

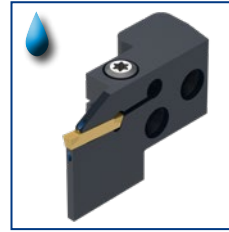

GLMCR/L P92 HP
p. 194



GLMCR/L P92 P
p. 195

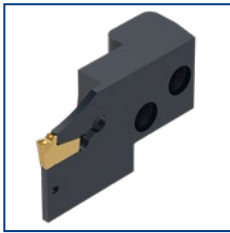

GLMCR/L F16
p. 195

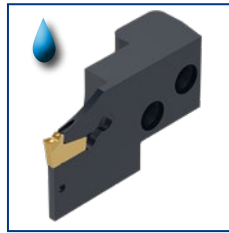

GLMCR/L F16 HP
p. 196

ISO-Cartridges

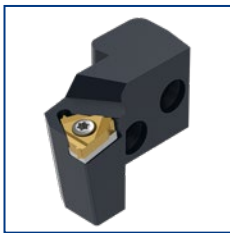

GLMCR/L 16EL/R ISO
p. 197

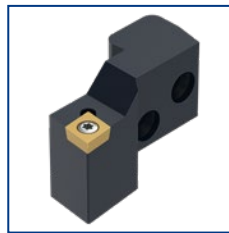

GLMCR/L CC09T3
p. 198

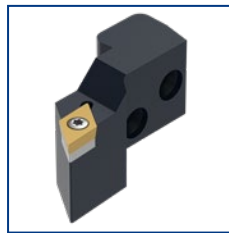

GLMCR/L DC11T3
p. 198

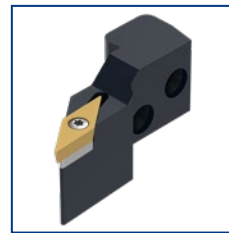

GLMCR/L VC1604
p. 198

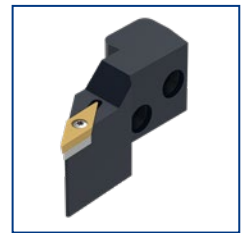

GLMCR/L VC1303
p. 198

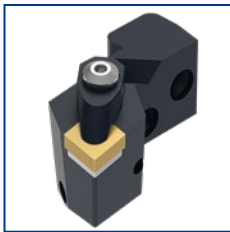

GLMCR/L CN1204
p. 199

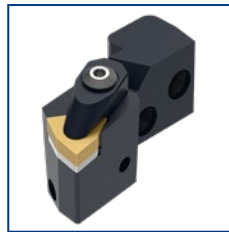

GLMCR/L WN0804
p. 199

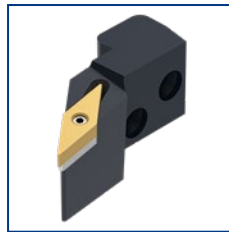

GLMCR/L VN1604
p. 199



GLMCR/L DN1506
p. 199

F92 Profiling tool system

Inserts and holders for profile cutting

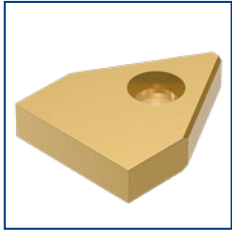

F 00000
p. 205

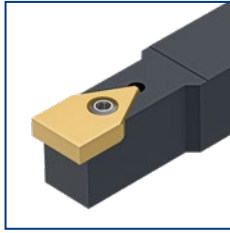

F92 SFCCN
p. 206

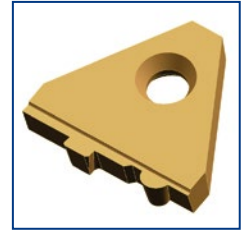

e.g. Profile insert
p. 205, 211

Internal cooling (IC) with individual connections

Basic tool holders



M92 Q FXCB R/L...HP
p. 219

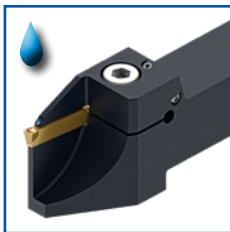

P92 CXCB R/L...HP
p. 219



P92 A CXCB R/L...HP
p. 220



F16 R/L...HP
p. 221

Spare parts and accessories

Spare parts



Screws + Wrenches
p. 224

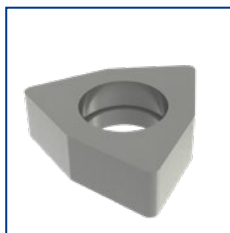

Spare parts for ISO
p. 225

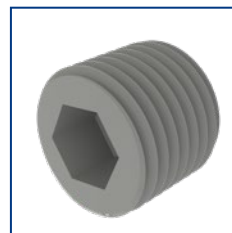

Spare parts for IC
p. 225

Torque tools



Torque VARIO ST plus
p. 226



Torque Vario-S
p. 226

Torque interchangeable blades



WT/F Torx
p. 226



WS/F Sechskant
p. 226

Screwdriver with interchangeable blades for MULTICUT holders



TX 25 10
p. 227

M92 Q MULTICUT 4

*The perfect grooving and cutting system
for many applications*

- ▶ *Parting off and grooving*
- ▶ *Threading*
- ▶ *Precision grooving*
- ▶ *Full radius grooving*
- ▶ *Special profiles*

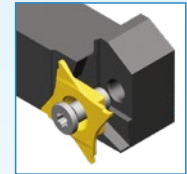

↑
Perfect
assembly

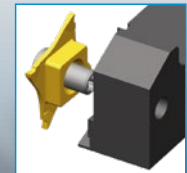

M92 Q MULTICUT 4

The perfect grooving and cutting system for many applications

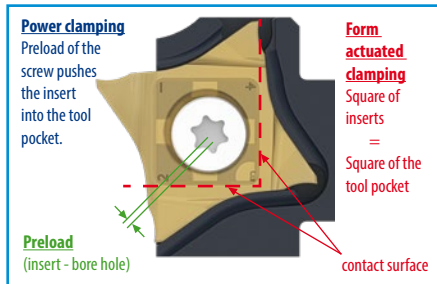

Vertical positioned inserts are well known. However, the segmented MULTICUT 4 inserts represent the new state of art technology. This improved development features a lot of advantages:



Perfect power and form actuated clamping.



Reinforced solidity of inserts suppresses vibrations. Achieves high and constant tool life. Maintains reliability on cutting operations.

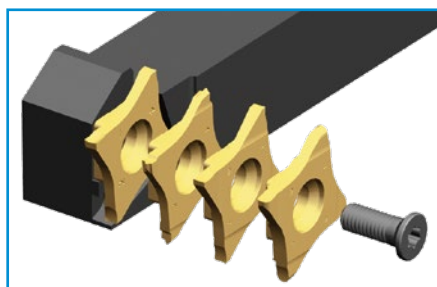

Reinforced area of the cutting edge grants stability.



In case a cutting edge is damaged all other edges can be used independently.

Precise re-positioning when changing cutting edges.

Fast and safe fixing in pocket.

Only one insert pocket for many inserts for different cutting operations.

Positive top rake with mould-shaped chip breaker starting from width $S = 1,5$ mm.

MULTICUT 4 - Insert designation code

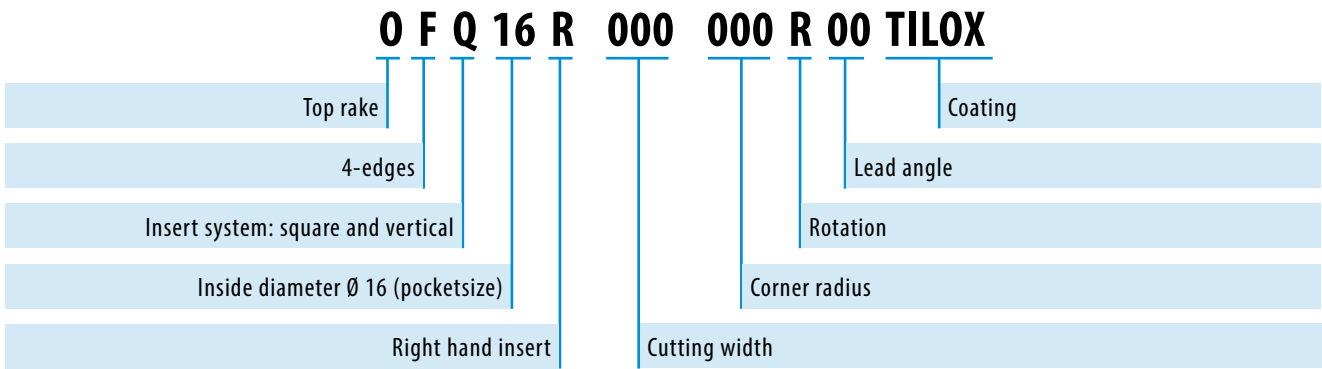

MULTICUT 4
sharp teeth - sharp edges



Threading



Cutting



Precision grooving



Selections

MULTICUT 4 - Designation code for tool holders and blades

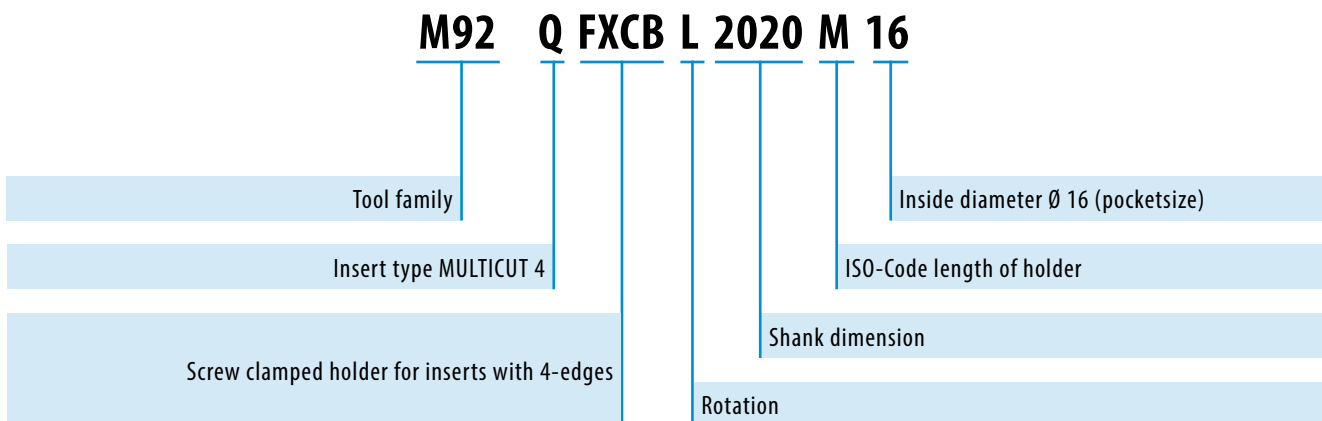

Optimal clamping and releasing - Special screwdriver for MULTICUT 4 holders and blades (incl. in orderextensive)

Special screwdriver and torx screws with interchangeable blade to change Multicut 4 inserts in confined space.

Rotation!

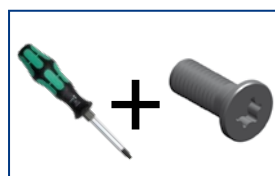
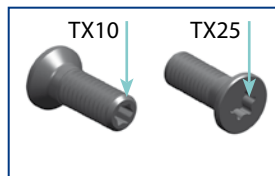

ET-Nr.	WG355 Ref.	ID-Nr.	Item	Recommended torque max. [Nm]
33	TXM5x14 10 25	44641	Torx screw L=14	4,5
34	TXM5x10 10 25	44817	Torx screw L=10	4,5

Bestelldaten

WG355 Ref.	ID-Nr.	Item
TX25 10 1	45131	Set content: spare part numbers 39 + 40 + 33
TX25 10 2	45132	Set content: spare part numbers 39 + 40 + 34

Detailed description on page 227

Coatings

ALOX

Coating type:
Supernitrid



Description: Ideal coating for interrupted cuts and crusts with high wear resistance.
Application: cast iron, free cutting steel.
Layer thickness: 6 µm
Layer composition: Nanocomposite, TiAlN

AluSpeed

Coating type:
Borid



Description: High performance coating for smooth surfaces and easy chip flow.
Application: Aluminium, aluminium alloys, Titanium and non ferrous material.
Layer thickness: 2 µm
Layer composition: Monolayer

CARBOSPEED

Coating type:
Powernitrid

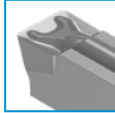

Description: Dense and hard coating layer with low residual stress. Excellent adhesive force and fine smooth surface.
Application: low and high alloy steel.
Layer thickness: 3 µm
Layer composition: Nanocomposite, TiAlCrN

CASTSPEED

Coating type:
MT-CVD
Gasphasen-
deposition

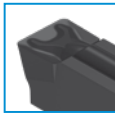

Description: Perfectly connected to the lower layers. Extremely smooth surface. Suitable for dry machining.
Application: gray cast iron, alloy gray iron, spheroidal iron and malleable cast iron.
Layer thickness: 8 µm
Layer composition: AlTiN

CASTSPEED PLUS

Coating type:
MT-CVD
Chemical
vapour deposition

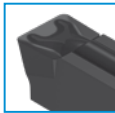

Description: very thick, smooth and wear resistant coating.
Application: gray cast iron, alloy gray iron, spheroidal iron and malleable cast iron.
Layer thickness: 22 µm
Layer composition: TiCN

Hardlox 2

Coating type:
Supernitrid



Description: Micro crystalline structure of the coating layer. Hardlox2 has been developed for hard materials with a hardness of more than 60HRC (Rockwell hardness)
Application: hardened materials.
Layer thickness: 3 µm
Layer composition: Nanocomposite AlTiN

HARDSPEED

Coating type:
Supernitrid



Description: Micro crystalline structure of the coating layer provides smooth surfaces. For machining heat resistant materials with a hardness of more than 50HRC (Rockwell hardness).
Application: heat developing materials and difficult to cut materials.
Layer thickness: 3 µm
Layer composition: Nanocomposite, AlTiN

HYPERSPEED

Coating type:
Supernitrid



Description: Extremely fine and hard layer surface. Especially suitable for machining without coolant and difficult to cut materials.
Application: difficult to cut materials and titanium.
Layer thickness: 3 µm | **Layer composition:** Nanocomposite, AlTiN

NANOSPEED

Coating type:
Supernitrid



Description: This TiN ALOX coating combines extreme hardness with high toughness. Owing to the golden colour of the coating, wearmarks can be identified more easily.
Application: tool steels and stainless steels
Layer thickness: 3 µm
Layer composition: Nanocomposite, TiAlN

TILOX

Coating type:
Supernitrid

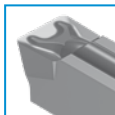

Description: The Tilox coating combines extreme hardness with high toughness and is suitable for a wide range of materials from steel to cast iron.
Application: steel, stainless steel and cast iron.
Layer thickness: 3 µm
Layer composition: Nanocomposite, TiAlN

MULTICUT 4 - Cutting inserts with 4 edges for grooving and parting off

OFQ16L..N/L
System M92-Q

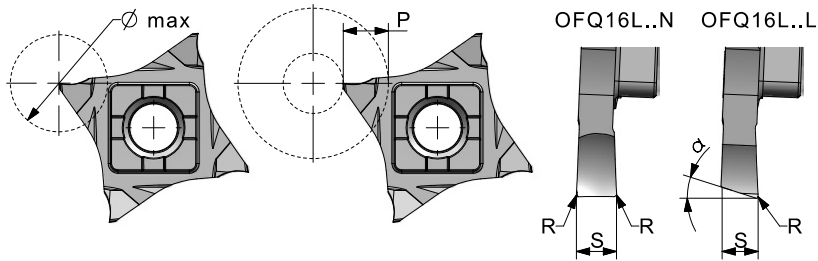
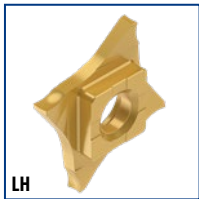

WG400 Ref.	FM NANOSPEED ID-Nr.	FM TILOX ID-Nr.	pocket size	⌀	P	R	S ^{+0.05}	α	Ømax.
OFQ16L 050 000 N 00	31019	31020	16	N	2,5	0,00	0,50	0	5,0
OFQ16L 100 000 N 00	31021	31022	16	N	3,5	0,00	1,00	0	7,0
OFQ16L 120 000 N 00	35046	38719	16	N	6,5	0,00	1,20	0	13,0
OFQ16L 150 010 N 00	31239	31238	16	N	6,5	0,10	1,50	0	13,0
OFQ16L 200 010 N 00	31026	31027	16	N	6,5	0,10	2,00	0	13,0
OFQ16L 200 020 N 00	43669	43670	16	N	6,5	0,20	2,00	0	13,0
OFQ16L 250 010 N 00	30946	31028	16	N	6,5	0,10	2,50	0	13,0
OFQ16L 250 020 N 00	43671	43672	16	N	6,5	0,20	2,50	0	13,0
OFQ16L 300 010 N 00	31029	31030	16	N	6,5	0,10	3,00	0	13,0
OFQ16L 300 020 N 00	43673	43674	16	N	6,5	0,20	3,00	0	13,0
OFQ16L 100 000 L 06	31031	31032	16	L	3,5	0,00	1,00	6	7,0
OFQ16L 100 000 L 15	31033	31034	16	L	3,5	0,00	1,00	15	7,0
OFQ16L 120 000 L 06	38720	38721	16	L	6,5	0,00	1,20	6	13,0
OFQ16L 150 010 L 06	37813	26738	16	L	6,5	0,10	1,50	6	13,0
OFQ16L 150 010 L 15	31266	31265	16	L	6,5	0,10	1,50	15	13,0
OFQ16L 200 010 L 06	31039	31040	16	L	6,5	0,10	2,00	6	13,0
OFQ16L 200 020 L 06	43675	43676	16	L	6,5	0,20	2,00	6	13,0
OFQ16L 200 010 L 15	31041	31042	16	L	6,5	0,10	2,00	15	13,0
OFQ16L 200 020 L 15	43677	43678	16	L	6,5	0,20	2,00	15	13,0

Comment:

Segmented and ground micrograin insert.
Positive top-rake with **chipforming** groove, beginning with 1,5 mm width to 3mm.

Fitting tools

p. 44, 193	p. 229	p. 230	p. 232	p. 43, 44	p. 45	p. 45	p. 53 - 54	p. 193

MULTICUT 4 - Cutting insert with 4 edges for grooving and parting off

OFQ16R...N/R
System M92-Q

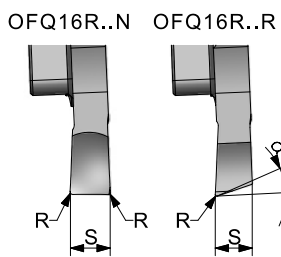
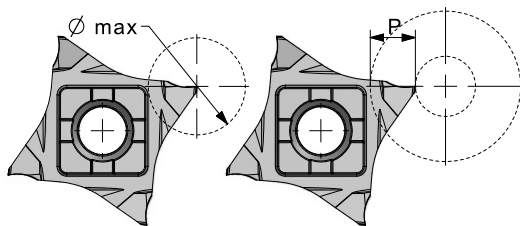

WG 400 Ref.	FM NANOSPEED ID-Nr.	FM TILOX ID-Nr.	pocket size	()	P	R	S ^{+0,05}	α	Ømax.
OFQ16R 050 000 N 00	30971	30972	16	N	2,5	0,00	0,50	0	5,0
OFQ16R 100 000 N 00	30973	30974	16	N	3,5	0,00	1,00	0	7,0
OFQ16R 120 000 N 00	35044	38722	16	N	6,5	0,00	1,20	0	13,0
OFQ16R 150 010 N 00	31257	31237	16	N	6,5	0,10	1,50	0	13,0
OFQ16R 200 010 N 00	30977	30978	16	N	6,5	0,10	2,00	0	13,0
OFQ16R 200 020 N 00	43679	43680	16	N	6,5	0,20	2,00	0	13,0
OFQ16R 250 010 N 00	30945	30979	16	N	6,5	0,10	2,50	0	13,0
OFQ16R 250 020 N 00	43681	43682	16	N	6,5	0,20	2,50	0	13,0
OFQ16R 300 010 N 00	30980	30981	16	N	6,5	0,10	3,00	0	13,0
OFQ16R 300 020 N 00	43683	43684	16	N	6,5	0,20	3,00	0	13,0
OFQ16R 100 000 R 06	30982	30983	16	R	3,5	0,00	1,00	6	7,0
OFQ16R 100 000 R 15	30984	30985	16	R	3,5	0,00	1,00	15	7,0
OFQ16R 120 000 R 06	38723	38724	16	R	6,5	0,00	1,20	6	13,0
OFQ16R 150 010 R 06	31262	31261	16	R	6,5	0,10	1,50	6	13,0
OFQ16R 150 010 R 15	31264	31263	16	R	6,5	0,10	1,50	15	13,0
OFQ16R 200 010 R 06	30990	30991	16	R	6,5	0,10	2,00	6	13,0
OFQ16R 200 020 R 06	43685	43686	16	R	6,5	0,20	2,00	6	13,0
OFQ16R 200 010 R 15	30992	30993	16	R	6,5	0,10	2,00	15	13,0
OFQ16R 200 020 R 15	43687	43688	16	R	6,5	0,20	2,00	15	13,0

Comment:

Segmented and ground micro-grain insert.
Positive top-rake with **chipforming** groove,
beginning with 1,5 mm width to 3mm.

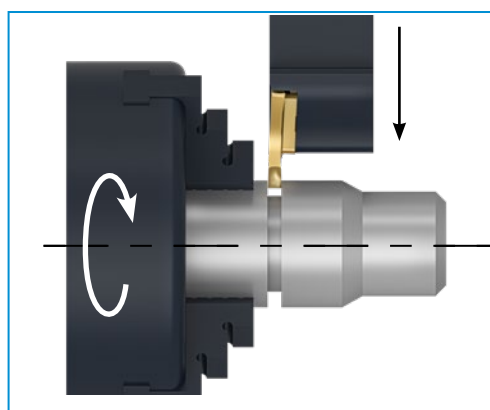

MULTICUT 4

Only one insert pocket for many different applications.

- Parting off and grooving
- Threading
- Precision grooving
- Full radius grooving
- Special profiles

Fitting tools



MULTICUT 4 - Precision grooving inserts according to DIN 471

OFQ16L...N

System M92-Q



LH

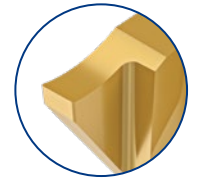
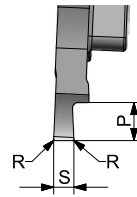
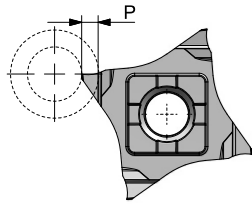

Enlarged view

WG400 Ref.	FM NANOSPEED ID-Nr.	FM TILOX ID-Nr.	pocket size	()	P	R	width	S ^{-0,05}
OFQ16L 050 000 N	31152	31153	16	L	1,0	0,00	0,50	0,57
OFQ16L 060 000 N	31154	31155	16	L	1,0	0,00	0,60	0,67
OFQ16L 070 000 N	31156	31157	16	L	1,5	0,00	0,70	0,77
OFQ16L 080 000 N	31158	31159	16	L	1,5	0,00	0,80	0,87
OFQ16L 090 000 N	31160	31161	16	L	1,5	0,00	0,90	0,97
OFQ16L 100 000 N	38725	38727	16	L	1,5	0,00	1,00	1,07
OFQ16L 110 010 N	31162	31163	16	L	1,5	0,10	1,10	1,24
OFQ16L 130 010 N	31164	31165	16	L	1,5	0,10	1,30	1,44
OFQ16L 160 010 N	31172	31173	16	L	2,0	0,10	1,60	1,74
OFQ16L 185 010 N	31174	31175	16	L	2,0	0,10	1,85	1,99
OFQ16L 215 010 N	31176	31177	16	L	2,5	0,10	2,15	2,29
OFQ16L 265 010 N	31178	31179	16	L	2,5	0,10	2,65	2,79
OFQ16L 315 010 N	31180	31181	16	L	2,5	0,10	3,15	3,29

OFQ16R...N

System M92-Q



RH

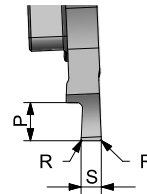
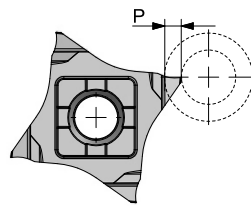

Enlarged view

WG400 Ref.	FM NANOSPEED ID-Nr.	FM TILOX ID-Nr.	pocket size	()	P	R	width	S ^{-0,05}
OFQ16R 050 000 N	31127	31128	16	R	1,0	0,00	0,50	0,57
OFQ16R 060 000 N	31129	31130	16	R	1,0	0,00	0,60	0,67
OFQ16R 070 000 N	31131	31132	16	R	1,5	0,00	0,70	0,77
OFQ16R 080 000 N	31133	31134	16	R	1,5	0,00	0,80	0,87
OFQ16R 090 000 N	31136	31137	16	R	1,5	0,00	0,90	0,97
OFQ16R 100 000 N	38726	38728	16	R	1,5	0,00	1,00	1,07
OFQ16R 110 010 N	31138	31139	16	R	1,5	0,10	1,10	1,24
OFQ16R 130 010 N	31140	31141	16	R	1,5	0,10	1,30	1,44
OFQ16R 160 010 N	31142	31143	16	R	2,0	0,10	1,60	1,74
OFQ16R 185 010 N	31144	31145	16	R	2,0	0,10	1,85	1,99
OFQ16R 215 010 N	31146	31147	16	R	2,5	0,10	2,15	2,29
OFQ16R 265 010 N	31148	31149	16	R	2,5	0,10	2,65	2,79
OFQ16R 315 010 N	31150	31151	16	R	2,5	0,10	3,15	3,29

Comment: Segmented and ground micrograin insert.
Horizontal cutting edge and positive top rake.



p. 44, 193



p. 229



p. 230



p. 232



p. 43, 44



p. 45



p. 45



p. 53 - 54



p. 193

Fitting tools

MULTICUT 4 - Precision grooving inserts according to DIN 471 with chamfer

OFQ16L..P..M

System M92-Q

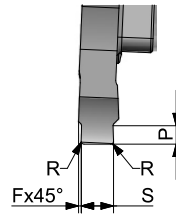
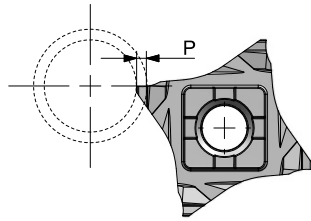
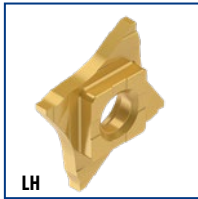

Enlarged view

WG400 Ref.	KM NANOSPEED ID-Nr.	pocket size	(C)	F	P	R		S ^{-0,05}
OFQ16L 110 010 P050 M	43103	16	L	0,15	0,50	0,10	1,10	1,24
OFQ16L 130 010 P067 M	43104	16	L	0,15	0,67	0,10	1,30	1,44
OFQ16L 160 010 P100 M	43105	16	L	0,15	1,00	0,10	1,60	1,74
OFQ16L 185 015 P125 M	43106	16	L	0,20	1,25	0,15	1,85	1,99
OFQ16L 215 015 P150 M	43107	16	L	0,20	1,50	0,15	2,15	2,29
OFQ16L 265 015 P150 M	43108	16	L	0,20	1,50	0,15	2,65	2,79
OFQ16L 265 015 P175 M	43109	16	L	0,20	1,75	0,15	2,65	2,79

Comment: Segmented and ground micrograin insert.
Horizontal cutting edge and positive top rake.

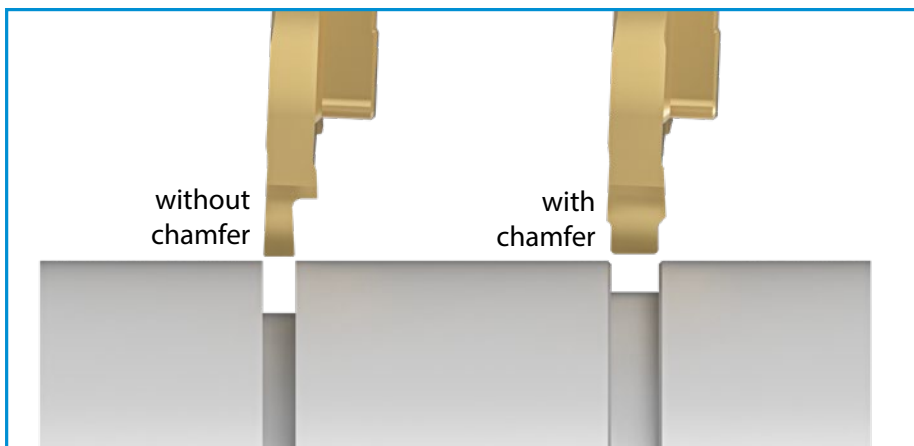

Execution Multicut with and without chamfer

Pro

Flexible cutting depth (until dimension P)

Contra

An additional insert for machining the chamfer necessary

Pro

No additional insert for chamfering necessary

Contra

Fix cutting depth P

Fitting tools



p. 44, 193



p. 229



p. 230



p. 232



p. 43, 44



p. 45



p. 45



p. 53 - 54



p. 54



p. 193

MULTICUT 4 - Inserts for face grooving



OFQ16L...A 50
System M92-Q

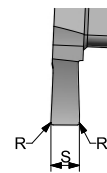
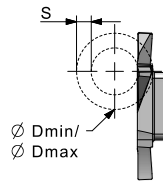
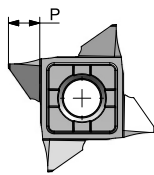

Enlarged view

WG400 Ref.	KM ID-Nr.	KM NANO-SPEED ID-Nr.	KM CARBO-SPEED ID-Nr.	pocket size	()	D min	D max	P	R	S +0.05
OFQ16L 150 010 A 50	55336	55344	55351	16	R	15	∞	5,0	0,10	1,50
OFQ16L 200 010 A 50	55337	55345	55352	16	R	20	∞	5,0	0,10	2,00
OFQ16L 250 020 A 50	55338	55346	55353	16	R	20	∞	5,0	0,20	2,50
OFQ16L 300 020 A 50	55339	55322	55354	16	R	20	∞	5,0	0,20	3,00



OFQ16R...A 50
System M92-Q

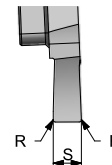
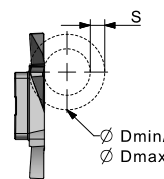
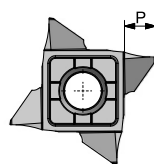

Enlarged view

WG400 Ref.	KM ID-Nr.	KM NANO-SPEED ID-Nr.	KM CARBO-SPEED ID-Nr.	pocket size	()	D min	D max	P	R	S +0.05
OFQ16R 150 010 A 50	55340	55347	55355	16	L	15	∞	5,0	0,10	1,50
OFQ16R 200 010 A 50	55341	55348	55356	16	L	20	∞	5,0	0,10	2,00
OFQ16R 250 020 A 50	55342	55349	55357	16	L	20	∞	5,0	0,20	2,50
OFQ16R 300 020 A 50	55343	55350	55358	16	L	20	∞	5,0	0,20	3,00

Comment: The first groove must not be smaller than \varnothing D min.

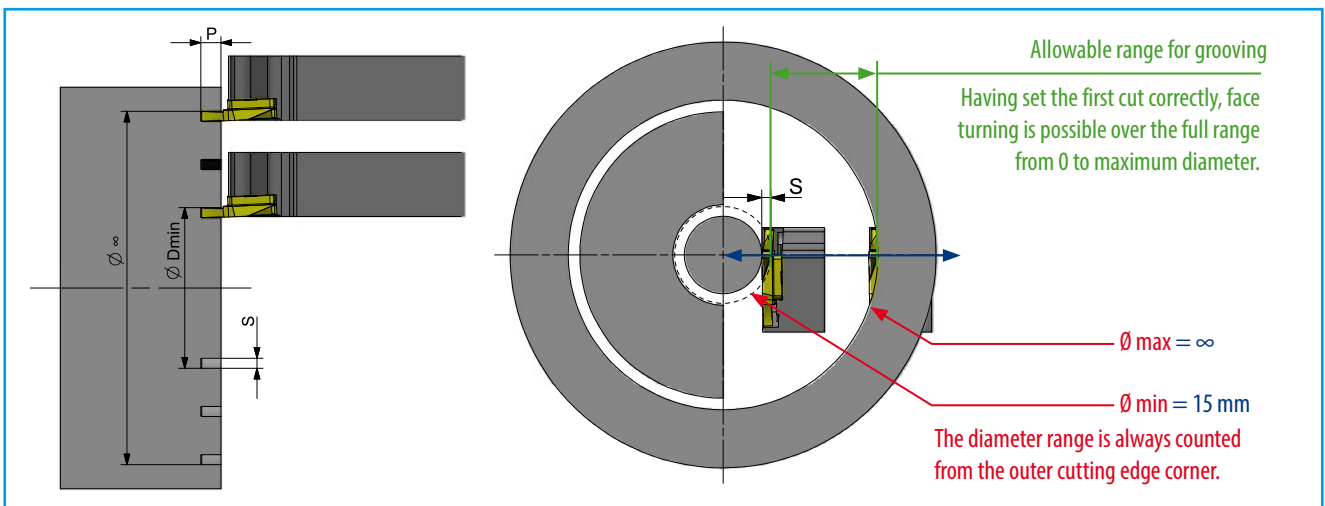

- Fitting tools**
- Internal cooling p. 44, 193
 - Tech. Section p. 229
 - pocket size p. 230
 - Intersection (main cutting edge) p. 232
 - p. 43, 44
 - p. 45
 - p. 45
 - p. 193

MULTICUT 4 - Full radius insert for grooving and copying

OFQ16L..R..N

System M92-Q

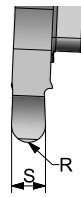
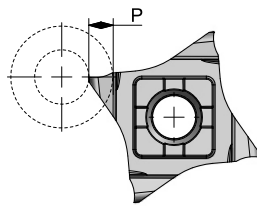

Enlarged view

WG400 Ref.	FM NANOSPEED ID-Nr.	FM TILOX ID-Nr.	pocket size	(C)	P	R	S +0,05
OFQ16L 100 R050 N	31202	31203	16	L	1,0	0,50	1,00
OFQ16L 150 R075 N	31204	31205	16	L	1,5	0,75	1,50
OFQ16L 200 R100 N	31206	31207	16	L	2,0	1,00	2,00
OFQ16L 250 R125 N	31208	31209	16	L	2,5	1,25	2,50
OFQ16L 300 R150 N	31210	31211	16	L	3,0	1,50	3,00

OFQ16R..R..N

System M92-Q

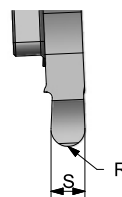
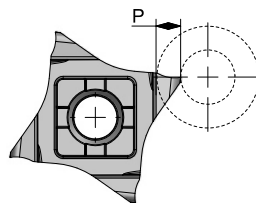

Enlarged view

WG400 Ref.	FM NANOSPEED ID-Nr.	FM TILOX ID-Nr.	pocket size	(C)	P	R	S +0,05
OFQ16R 100 R050 N	31187	31188	16	R	1,0	0,50	1,00
OFQ16R 150 R075 N	31189	31190	16	R	1,5	0,75	1,50
OFQ16R 200 R100 N	31191	31192	16	R	2,0	1,00	2,00
OFQ16R 250 R125 N	31193	31194	16	R	2,5	1,25	2,50
OFQ16R 300 R150 N	31195	31196	16	R	3,0	1,50	3,00

Comment: Segmented and ground micrograin insert.
Horizontal cutting edge and positive top rake.

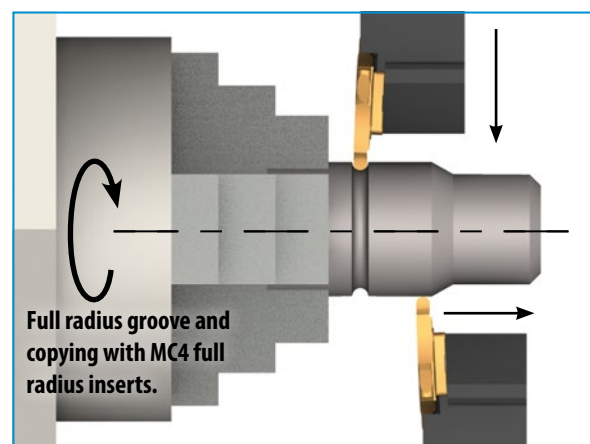

Fitting tools

- 

Internal cooling
p. 44, 193
- 

Tech. Section
p. 229
- 

pocket size
p. 230
- 

Intersection (main cutting edge)
p. 232
- 

p. 43, 44
- 

p. 45
- 

p. 45
- 

p. 53 - 54
- 

p. 193

MULTICUT 4 - Precision threading inserts external for ISO- and withworth full profile

OFQ16L...EL
System M92-Q

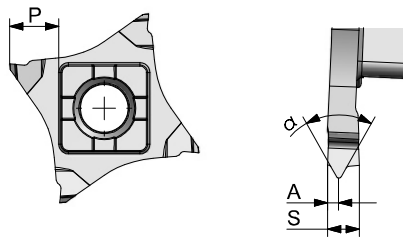
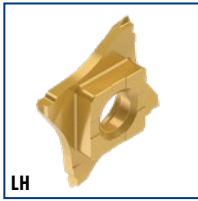

Enlarged view

WG400 Ref.	FM NANOSPEED ID-Nr.	FM TILOX ID-Nr.	pocket size	()		A	P	S	α°
OFQ16L 200 050 EL ISO	31418	31419	16	L	0,50	0,5	6,5	2,0	60
OFQ16L 200 070 EL ISO	31420	31421	16	L	0,70	0,5	6,5	2,0	60
OFQ16L 200 075 EL ISO	31422	31423	16	L	0,75	0,5	6,5	2,0	60
OFQ16L 200 080 EL ISO	31424	31425	16	L	0,80	0,7	6,5	2,0	60
OFQ16L 200 100 EL ISO	31426	31427	16	L	1,00	0,7	6,5	2,0	60
OFQ16L 200 125 EL ISO	31428	31429	16	L	1,25	0,7	6,5	2,0	60
OFQ16L 200 28W EL	31430	31431	16	L	28 G/inch	1,0	6,5	2,0	55
OFQ16L 200 19W EL	31432	31433	16	L	19 G/inch	1,0	6,5	2,0	55
OFQ16L 350 14W EL	31434	31435	16	L	14 G/inch	1,3	6,5	3,5	55
OFQ16L 350 11W EL	31436	31437	16	L	11 G/inch	1,5	6,5	3,5	55
OFQ16L 350 150 EL ISO	31438	31439	16	L	1,50	0,8	6,5	3,5	60
OFQ16L 350 175 EL ISO	31440	31441	16	L	1,75	0,9	6,5	3,5	60
OFQ16L 350 200 EL ISO	31442	31443	16	L	2,00	1,0	6,5	3,5	60
OFQ16L 350 250 EL ISO	37451	34994	16	L	2,50	1,3	6,5	3,5	60
OFQ16L 350 300 EL ISO	37452	34995	16	L	3,00	1,8	6,5	3,5	60

Delivery time and price on request, minimum purchase 3 pieces.

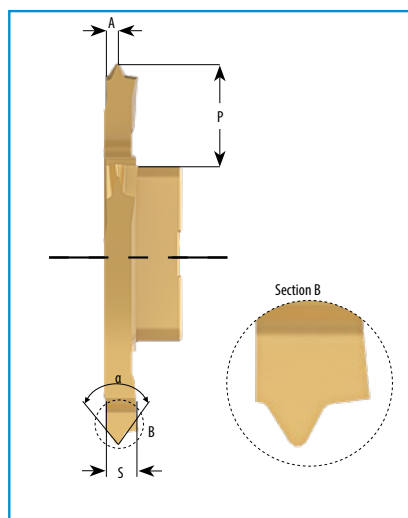

Precision ground threading inserts for external threads:

The vertical position of the insert, its positive top rake, large chip chambers, large front clearance and coated micrograin carbide together create perfect conditions for difficult threading operations.

Fitting tools

- Internal cooling
p. 44, 193
- Tech. Section
p. 229
- pocket size
p. 230
- Intersection (main cutting edge)
p. 232
- p. 43, 44
- p. 45
- p. 45
- p. 193

MULTICUT 4 - Precision threading inserts external for ISO- and Withworth full profile

OFQ16R...ER
System M92-Q

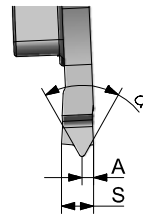
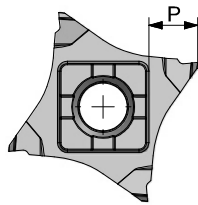
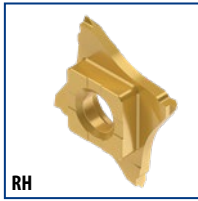

Enlarged view

WG400 Ref.	FM NANOSPEED ID-Nr.	FM TILOX ID-Nr.	pocket size	()		A	P	S	α°
OFQ16R 200 050 ER ISO	31294	31297	16	R	0,50	0,5	6,5	2,0	60
OFQ16R 200 070 ER ISO	31298	31299	16	R	0,70	0,5	6,5	2,0	60
OFQ16R 200 075 ER ISO	31393	31394	16	R	0,75	0,5	6,5	2,0	60
OFQ16R 200 080 ER ISO	31395	31396	16	R	0,80	0,7	6,5	2,0	60
OFQ16R 200 100 ER ISO	31397	31400	16	R	1,00	0,7	6,5	2,0	60
OFQ16R 200 125 ER ISO	31401	31402	16	R	1,25	0,7	6,5	2,0	60
OFQ16R 200 28W ER	31403	31404	16	R	28 G/inch	1,0	6,5	2,0	55
OFQ16R 200 19W ER	31405	31406	16	R	19 G/inch	1,0	6,5	2,0	55
OFQ16R 350 14W ER	31407	31408	16	R	14 G/inch	1,3	6,5	3,5	55
OFQ16R 350 11W ER	31409	31410	16	R	11 G/inch	1,5	6,5	3,5	55
OFQ16R 350 150 ER ISO	31411	31412	16	R	1,50	0,8	6,5	3,5	60
OFQ16R 350 175 ER ISO	31413	31414	16	R	1,75	0,9	6,5	3,5	60
OFQ16R 350 200 ER ISO	31415	31417	16	R	2,00	1,0	6,5	3,5	60
OFQ16R 350 250 ER ISO	37450	34992	16	R	2,50	1,3	6,5	3,5	60
OFQ16R 350 300 ER ISO	34130	34993	16	R	3,00	1,8	6,5	3,5	60

Precision ground threading inserts for external threads:

The vertical position of the insert, its positive top rake, large chip chambers, large front clearance and coated micrograin carbide together create perfect conditions for difficult threading operations.

Fitting tools

- Internal cooling
 p. 44, 193
- Tech. Section
 p. 229
- pocket size
 p. 230
- Intersection (main cutting edge)
 p. 232
- p. 43, 44
- p. 45
- p. 45
- p. 193

MULTICUT 4 - Precision threading inserts external for ISO- and Withworth full profile

OFQ16L...EIR

System M92-Q

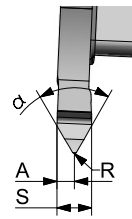
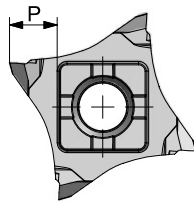

Enlarged view

WG400 Ref.	FM NANOSPEED ID-Nr.	FM TILOX ID-Nr.	pocket size	()		A	P	R	S	α°
OFQ16L 200 EIR55 28 W	43128	43129	16	L	28-20 G/inch	0,9	6,5	0,1	2,0	55
OFQ16L 200 EIR60 050	43130	43131	16	L	0,5-1,00	0,9	6,5	0,1	2,0	60
OFQ16L 250 EIR55 19 W	43132	43133	16	L	19-14 G/inch	1,2	6,5	0,2	2,5	55
OFQ16L 250 EIR60 125	43134	43135	16	L	1,25-1,75	1,2	6,5	0,2	2,5	60
OFQ16L 350 EIR55 12 W	43136	43137	16	L	12-10 G/inch	1,8	6,5	0,3	3,5	55
OFQ16L 350 EIR60 200	43138	43139	16	L	2,00-3,00	1,8	6,5	0,3	3,5	60

Delivery time and price on request, minimum purchase 3 pieces.

OFQ16R...EIR

System M92-Q

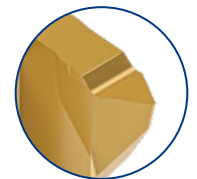
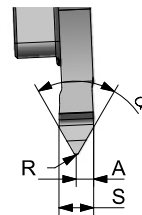
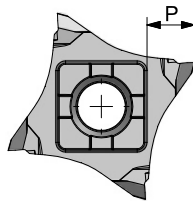

Enlarged view

WG400 Ref.	FM NANOSPEED ID-Nr.	FM TILOX ID-Nr.	pocket size	()		A	P	R	S	α°
OFQ16R 200 EIR55 28 W	43140	43141	16	R	28-20 G/inch	0,9	6,5	0,1	2,0	55
OFQ16R 200 EIR60 050	43142	43143	16	R	0,5-1,00	0,9	6,5	0,1	2,0	60
OFQ16R 250 EIR55 19 W	43144	43145	16	R	19-14 G/inch	1,2	6,5	0,2	2,5	55
OFQ16R 250 EIR60 125	43146	43147	16	R	1,25-1,75	1,2	6,5	0,2	2,5	60
OFQ16R 350 EIR55 12 W	43148	43149	16	R	12-10 G/inch	1,8	6,5	0,3	3,5	55
OFQ16R 350 EIR60 200	43150	43151	16	R	2,00-3,00	1,8	6,5	0,3	3,5	60



p. 44, 193



p. 229



p. 230



p. 232



p. 43, 44



p. 45



p. 45



p. 193

Fitting tools

Hard material machining



*Inserts, coating and tool holders
for parting off, grooving and turning*

Inserts with efficient chip breakers and special coating HARDLOX 2[®] for:

- ▶ *hardened materials*
- ▶ *machining hardened materials*
- ▶ *exotic and tempered materials*

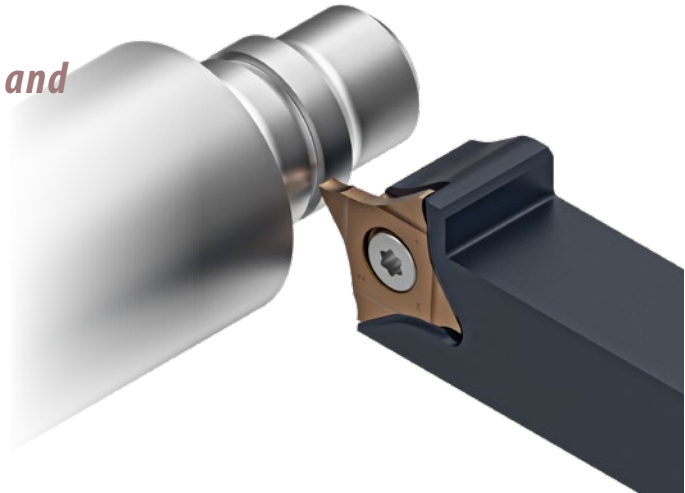

Machining materials with a Rockwell hardness of 54 and more. Inserts and holders are stressed heavily on such operations. Therefore starting-up speeds, feeds and depths should be low graded.

HARDLOX 2[®]

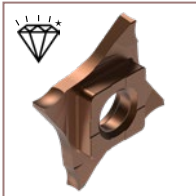

- Polished edges and surfaces
- Low price alternative compared with CBN tipped inserts
- To be used on unhardened steels as well
- Multi edge inserts available
- Constant performance when cutting from hard layer into soft core

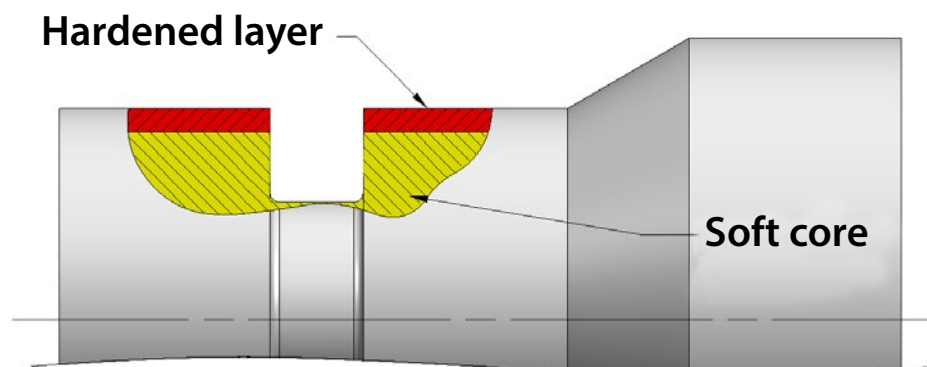

Remark: Other inserts with HARDLOX 2[®] on request.

MULTICUT 4 Inserts for grooving and parting off | Hard material machining

OFQ16 L...N00

System M92 Q

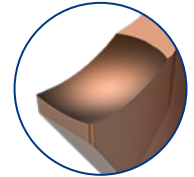
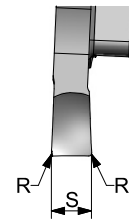
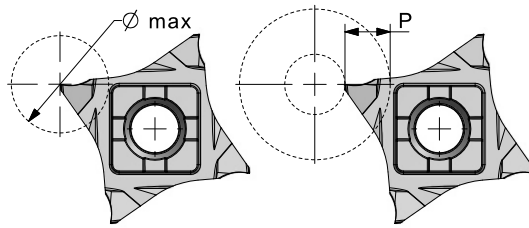
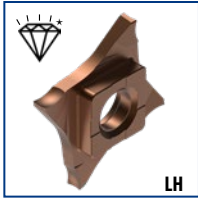

Enlarged view

WG404 Ref.	FM Hardlox2	pocket size	(C)	P	R	S ± 0,05	Ømax.
	ID-Nr.						
OFQ16L 100 000 N 00	44788	16	N	3,5	0,00	1,00	7,0
OFQ16L 120 000 N 00	38771	16	N	6,5	0,00	1,20	13,0
OFQ16L 150 010 N 00	38772	16	N	6,5	0,10	1,50	13,0
OFQ16L 200 010 N 00	38773	16	N	6,5	0,10	2,00	13,0
OFQ16L 200 020 N 00	43689	16	N	6,5	0,20	2,00	13,0
OFQ16L 250 010 N 00	55005	16	N	6,5	0,10	2,50	13,0
OFQ16L 250 020 N 00	55006	16	N	6,5	0,20	2,50	13,0
OFQ16L 300 010 N 00	55008	16	N	6,5	0,10	3,00	13,0
OFQ16L 300 020 N 00	55010	16	N	6,5	0,20	3,00	13,0

OFQ16 R...N00

System M92 Q

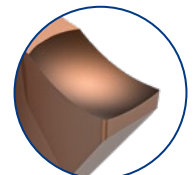
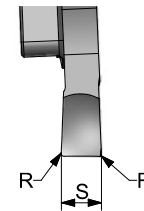
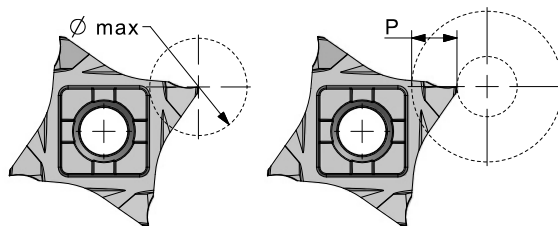

Enlarged view

WG404 Ref.	FM Hardlox2	pocket size	(C)	P	R	S ± 0,05	Ømax.
	ID-Nr.						
OFQ16R 100 000 N 00	56208	16	N	3,5	0,00	1,00	7,0
OFQ16R 120 000 N 00	38774	16	N	6,5	0,00	1,20	13,0
OFQ16R 150 010 N 00	38775	16	N	6,5	0,10	1,50	13,0
OFQ16R 200 010 N 00	38776	16	N	6,5	0,10	2,00	13,0
OFQ16R 200 020 N 00	43690	16	N	6,5	0,20	2,00	13,0
OFQ16R 250 010 N 00	55012	16	N	6,5	0,10	2,50	13,0
OFQ16R 250 020 N 00	55013	16	N	6,5	0,20	2,50	13,0
OFQ16R 300 010 N 00	55014	16	N	6,5	0,10	3,00	13,0
OFQ16R 300 020 N 00	55015	16	N	6,5	0,20	3,00	13,0

Fitting tools



p. 44, 193



p. 229



p. 230



p. 232



p. 43, 44



p. 45



p. 45



p. 53 - 54



p. 193

MULTICUT 4 - Full radius insert for grooving and copying | Hard material machining

OFQ16L..R..N

System M92-Q

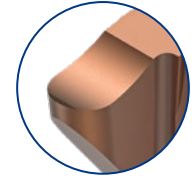
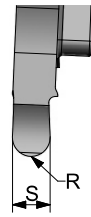
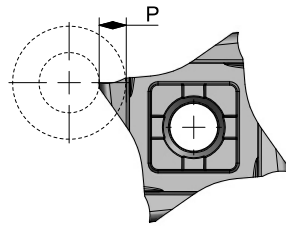
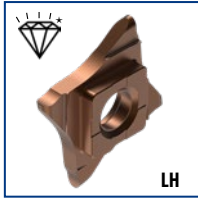

Enlarged view

WG404 Ref.	FM Hardlox 2 ID-Nr.	pocket size	()	P	R	S +0,05
OFQ16L 100 R050 N	55031	16	L	1,0	0,50	1,00
OFQ16L 150 R075 N	43481	16	L	1,5	0,75	1,50
OFQ16L 200 R100 N	55032	16	L	2,0	1,00	2,00
OFQ16L 250 R125 N	55033	16	L	2,5	1,25	2,50
OFQ16L 300 R150 N	55034	16	L	3,0	1,50	3,00

Comment: Segmented and ground micrograin insert. Horizontal cutting edge and positive top rake.

OFQ16R..R..N

System M92-Q

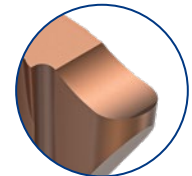
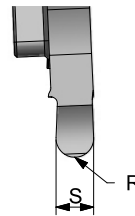
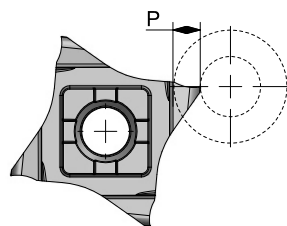

Enlarged view

WG404 Ref.	FM Hardlox 2 ID-Nr.	pocket size	()	P	R	S +0,05
OFQ16R 100 R050 N	55035	16	R	1,0	0,50	1,00
OFQ16R 150 R075 N	55039	16	R	1,5	0,75	1,50
OFQ16R 200 R100 N	55036	16	R	2,0	1,00	2,00
OFQ16R 250 R125 N	55037	16	R	2,5	1,25	2,50
OFQ16R 300 R150 N	55038	16	R	3,0	1,50	3,00

Comment: Segmented and ground micrograin insert. Horizontal cutting edge and positive top rake.

Fitting tools



p. 44, 193



p. 229



p. 230



p. 232



p. 43, 44



p. 45



p. 45



p. 53 - 54



p. 193

MULTICUT 4 - Precision grooving inserts according to DIN 471 | Hard material machining

OFQ16 L...N
System M92 Q

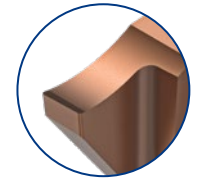
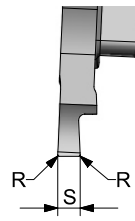
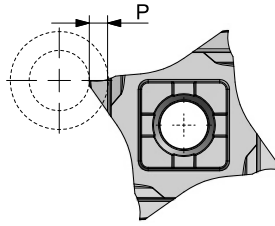
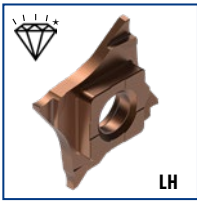

Enlarged view

WG404 Ref.	FM Hardlox 2	pocket size	(C)	P	R		S ^{-0,05}
	ID-Nr.						
OFQ16L 050 000 N	38781	16	L	1,0	0,00	0,50	0,57
OFQ16L 060 000 N	55004	16	L	1,0	0,00	0,60	0,67
OFQ16L 070 000 N	55007	16	L	1,5	0,00	0,70	0,77
OFQ16L 080 000 N	55009	16	L	1,5	0,00	0,80	0,87
OFQ16L 090 000 N	55011	16	L	1,5	0,00	0,90	0,97
OFQ16L 100 000 N	38782	16	L	1,5	0,00	1,00	1,07
OFQ16L 110 010 N	55016	16	L	1,5	0,10	1,10	1,24
OFQ16L 130 010 N	55017	16	L	1,5	0,10	1,30	1,44
OFQ16L 160 010 N	38783	16	L	2,0	0,10	1,60	1,74
OFQ16L 185 010 N	55019	16	L	2,0	0,10	1,85	1,99
OFQ16L 215 010 N	38784	16	L	2,5	0,10	2,15	2,29
OFQ16L 265 010 N	55020	16	L	2,5	0,10	2,65	2,79
OFQ16L 315 010 N	55021	16	L	2,5	0,10	3,15	3,29

OFQ16 R...N
System M92 Q

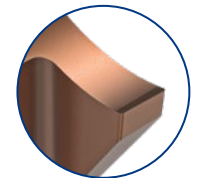
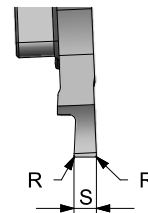
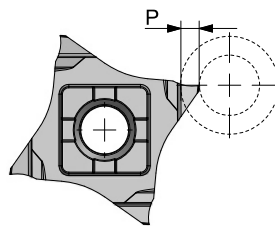

Enlarged view

WG404 Ref.	FM Hardlox 2	pocket size	(C)	P	R		S ^{-0,05}
	ID-Nr.						
OFQ16R 050 000 N	38777	16	R	1,0	0,00	0,50	0,57
OFQ16R 060 000 N	55022	16	R	1,0	0,00	0,60	0,67
OFQ16R 070 000 N	55023	16	R	1,5	0,00	0,70	0,77
OFQ16R 080 000 N	55024	16	R	1,5	0,00	0,80	0,87
OFQ16R 090 000 N	55025	16	R	1,5	0,00	0,90	0,97
OFQ16R 100 000 N	38778	16	R	1,5	0,00	1,00	1,07
OFQ16R 110 010 N	55026	16	R	1,5	0,10	1,10	1,24
OFQ16R 130 010 N	55027	16	R	1,5	0,10	1,30	1,44
OFQ16R 160 010 N	38779	16	R	2,0	0,10	1,60	1,74
OFQ16R 185 010 N	55028	16	R	2,0	0,10	1,85	1,99
OFQ16R 215 010 N	38780	16	R	2,5	0,10	2,15	2,29
OFQ16R 265 010 N	47854	16	R	2,5	0,10	2,65	2,79
OFQ16R 315 010 N	55029	16	R	2,5	0,10	3,15	3,29



MULTICUT 4 - Precision threading inserts external for ISO - & Whitworth full profile | hard material machining

OFQ16R...ER
System M92-Q

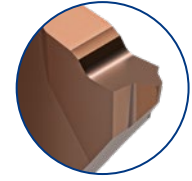
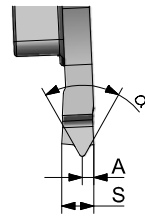
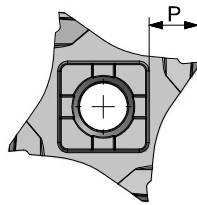
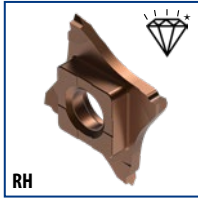

Enlarged view

WG404 Ref.	FM Hardlox 2 ID-Nr.	pocket size	()		A	P	S	α
OFQ16R 200 050 ER ISO	54985	16	R	0,50	0,5	6,5	2,0	60
OFQ16R 200 070 ER ISO	54961	16	R	0,70	0,5	6,5	2,0	60
OFQ16R 200 075 ER ISO	54962	16	R	0,75	0,5	6,5	2,0	60
OFQ16R 200 080 ER ISO	54987	16	R	0,80	0,7	6,5	2,0	60
OFQ16R 200 100 ER ISO	54988	16	R	1,00	0,7	6,5	2,0	60
OFQ16R 200 125 ER ISO	45201	16	R	1,25	0,7	6,5	2,0	60
OFQ16R 200 28W ER	54996	16	R	28 G/Zoll	1,0	6,5	2,0	55
OFQ16R 200 19W ER	54997	16	R	19 G/Zoll	1,0	6,5	2,0	55
OFQ16R 350 14W ER	54998	16	R	14 G/Zoll	1,3	6,5	3,5	55
OFQ16R 350 11W ER	54999	16	R	11 G/Zoll	1,5	6,5	3,5	55
OFQ16R 350 150 ER ISO	50333	16	R	1,50	0,8	6,5	3,5	60
OFQ16R 350 175 ER ISO	55000	16	R	1,75	0,9	6,5	3,5	60
OFQ16R 350 200 ER ISO	55001	16	R	2,00	1,0	6,5	3,5	60
OFQ16R 350 250 ER ISO	55002	16	R	2,50	1,3	6,5	3,5	60
OFQ16R 350 300 ER ISO	55003	16	R	3,00	1,8	6,5	3,5	60

Remark: LH inserts on request.



p. 44, 193



p. 229



p. 230



p. 232



p. 43, 44



p. 45



p. 45



p. 53 - 54



p. 54



p. 193

Fitting tools

MULTICUT 4 - holders for cutting, threading and precision grooving inserts

M92 Q FXCB L
System M92-Q



LH holders
for LH inserts

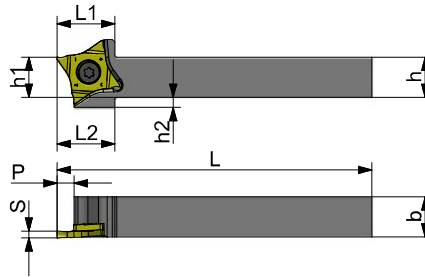

M92 Q FXCB R
System M92-Q

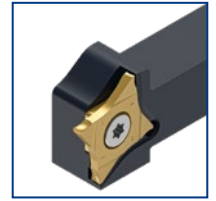

RH holders
for RH inserts

WG402 Ref.	ID-Nr.	pocket size	()	h	h1	h2	b	f	P	L	L1	L2	
M92 Q FXCBL 1012 K16	30306	16	L	10	10	10	12	12,3	6,5	125	23	27	34+39+40
M92 Q FXCBL 1212 K16	30312	16	L	12	12	8	12	12,3	6,5	125	23	27	34+39+40
M92 Q FXCBL 1616 K16	30316	16	L	16	16	4	16	16,3	6,5	125	23	23	33+39+40
M92 Q FXCBL 2020 K16	29120	16	L	20	20	-	20	20,3	6,5	125	23	-	33+39+40
M92 Q FXCBL 2525 M16	30320	16	L	25	25	-	25	25,3	6,5	150	23	-	33+39+40
M92 Q FXCBR 1012 K16	30324	16	R	10	10	10	12	12,3	6,5	125	23	27	34+39+40
M92 Q FXCBR 1212 K16	30328	16	R	12	12	8	12	12,3	6,5	125	23	27	34+39+40
M92 Q FXCBR 1616 K16	30332	16	R	16	16	4	16	16,3	6,5	125	23	23	33+39+40
M92 Q FXCBR 2020 K16	30302	16	R	20	20	-	20	20,3	6,5	125	23	-	33+39+40
M92 Q FXCBR 2525 M16	30336	16	R	25	25	-	25	25,3	6,5	150	23	-	33+39+40

Remark: 
Only RH inserts will fit into RH tool holders and blades. Only RH inserts will fit into RH tool holders and blades.

How to write an order:

1 pc. M92 Q FXCB**R** 1012 K16 or: **1 pc. ID-Nr. 30324** **recommended**

5 pcs. OFQ 16**R** 050 000N FM TILOX or: **5 pcs. ID-Nr. 31128**

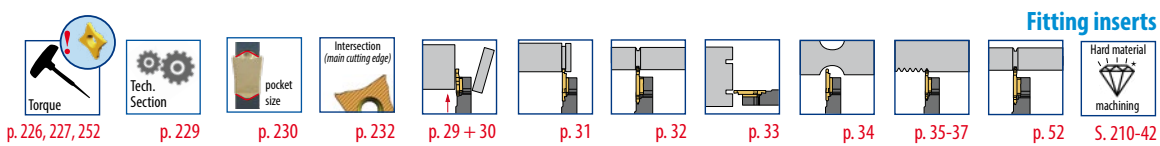

MULTICUT 4 - Holder with internal cooling for grooving, threading and precision grooving

M92 Q FXCB L HP
System M92-Q

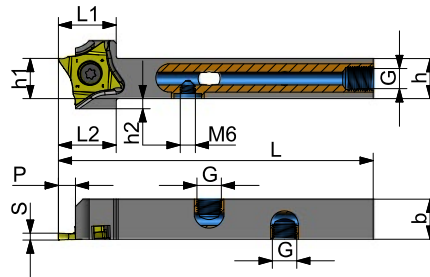

M92 Q FXCB R HP
System M92-Q

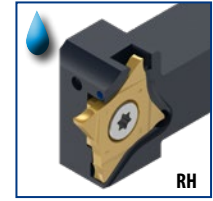

WG4020 Ref.	ID-Nr.	pocket size	(C)	G	h	h1	h2	b	f	P	L	L1	L2	
M92 Q FXCBL 1212 K16HPM8x1	56581	16	L	M8x1	12	12	8	12	12,3	6,5	125	23,0	27	34+39+40
M92 Q FXCBL 1616 K16HPG1/8	56585	16	L	G1/8	16	16	4	16	16,3	6,5	125	23,0	19,5	33+39+40
M92 Q FXCBL 2020 K16HPG1/8	56587	16	L	G1/8	20	20	-	20	20,3	6,5	125	23,0	-	33+39+40
M92 Q FXCBL 2525 M16HPG1/8	56590	16	L	G1/8	25	25	-	25	25,3	6,5	150	23,0	-	33+39+40
M92 Q FXCBR 1212 K16HPM8x1	56584	16	R	M8x1	12	12	8	12	12,3	6,5	125	23,0	27	34+39+40
M92 Q FXCBR 1616 K16HPG1/8	56586	16	R	G1/8	16	16	4	16	16,3	6,5	125	23,0	19,5	33+39+40
M92 Q FXCBR 2020 K16HPG1/8	56588	16	R	G1/8	20	20	-	20	20,3	6,5	125	23,0	-	33+39+40
M92 Q FXCBR 2525 M16HPG1/8	56591	16	R	G1/8	25	25	-	25	25,3	6,5	150	23,0	-	33+39+40

Remark:

Only RH inserts will fit into RH tool holders and blades. Only RH inserts will fit into RH tool holders and blades.

Fitting inserts

Torque p. 226, 227, 252
 Tech. Section p. 229
 pocket size p. 230
 Intersection (main cutting edge) p. 232
 p. 29 + 30
 p. 31
 p. 32
 p. 33
 p. 34
 p. 35-37
 p. 52
 Hard material machining S. 210-42

MULTICUT 4 - 90° holders for many different turning applications

M92 Q 90 FXCBL
System M92-Q

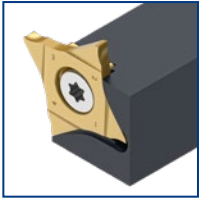

LH holder
for RH inserts

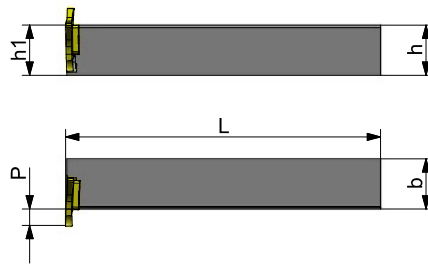

M92 Q 90 FXCBR
System M92-Q

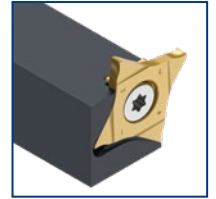

RH holder
for LH inserts

WG402 Ref.	ID-Nr.	pocket size	()	h	h1	b	P	L	
M92 Q 90 FXCBL 2020 K16	43343	16	L	20	20	20	6,5	125	33+39+40
M92 Q 90 FXCBR 2020 K16	43342	16	R	20	20	20	6,5	125	33+39+40

Remark: Only RH inserts will fit into RH tool holders and blades.
Only RH inserts will fit into RH tool holders and blades.



Fitting inserts

Torque p. 226, 227, 252 Tech. Section p. 229 pocket size p. 230 Intersection (main cutting edge) p. 232 p. 29 + 30 p. 31 p. 32 p. 33 p. 34 p. 35-37 p. 52

MULTICUT 4 - Blades for cutting, threading and precision grooving inserts

M92 Q...X..L
System M92-Q



LH blades
for LH inserts

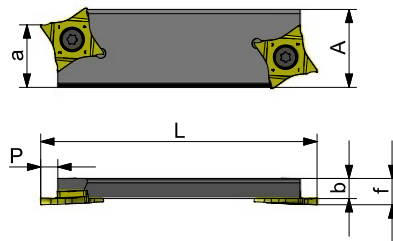

M92 Q...X..R
System M92-Q



RH blades
for RH inserts

WG401 Ref.	ID-Nr.	pocket size	()	A	a	b	f	P	L	
M92 Q FXCBL 2608 X16L	30349	16	L	26	21,4	8	10,5	6,5	110	34+39+40
M92 Q FXCBL 3208 X16L	29116	16	L	32	25,0	8	10,5	6,5	110	34+39+40
M92 Q FXCBR 2608 X16R	30353	16	R	26	21,4	8	10,5	6,5	110	34+39+40
M92 Q FXCBR 3208 X16R	30345	16	R	32	25,0	8	10,5	6,5	110	34+39+40

Remark: Each blade has got **2 insert pockets**.



Only RH inserts will fit into RH tool holders and blades. Only RH inserts will fit into RH tool holders and blades.

How to write an order:

recommended

1 pc. M92 Q FXCBR 2608 X16R or: **1 pc. ID-Nr. 30353**
5 pcs. OFQ 16R 050 000N FM TILOX or: **5 pcs. ID-Nr. 31128**

Fitting inserts

Torque p. 226, 227, 252 Tech. Section p. 229 pocket size p. 230 Intersection (main cutting edge) p. 232 p. 29 + 30 p. 31 p. 32 p. 33 p. 34 p. 35-37 p. 52 Hard material machining S. 210-42

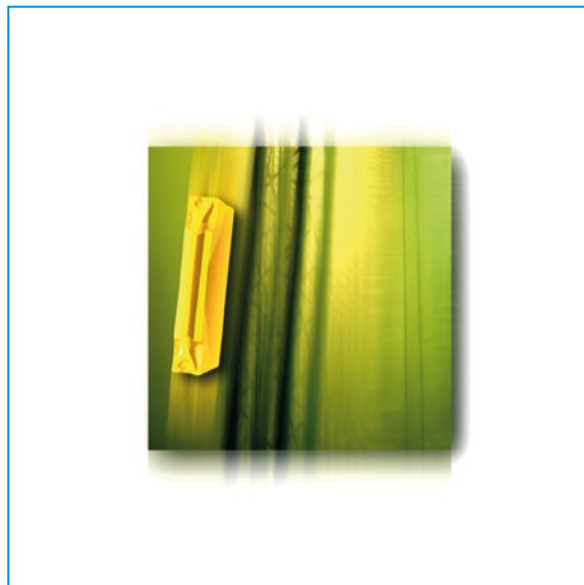

GLRM92 MULTICUT

Circular milling cutter

*The advantages of Multicut 4 system
combined with the applications on rotary tools*

▶ **Shank end mills**

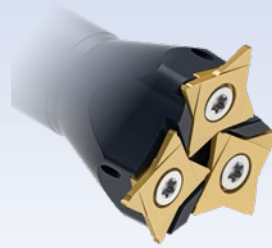

▶ **Milling heads**

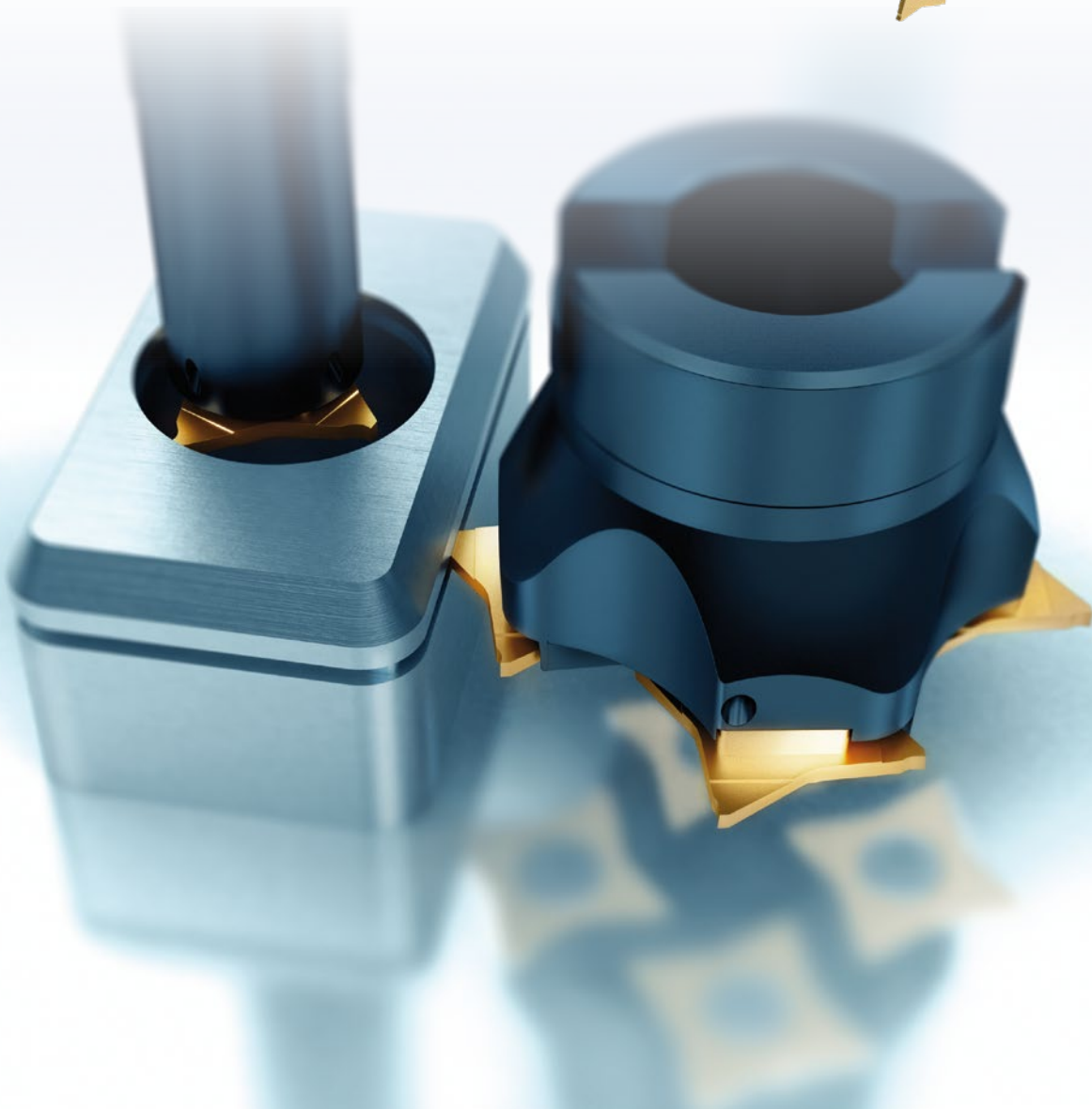





GLRM92 MULTICUT Circular milling cutter

The advantages of Multicut 4 System combined with the applications of rotary tools

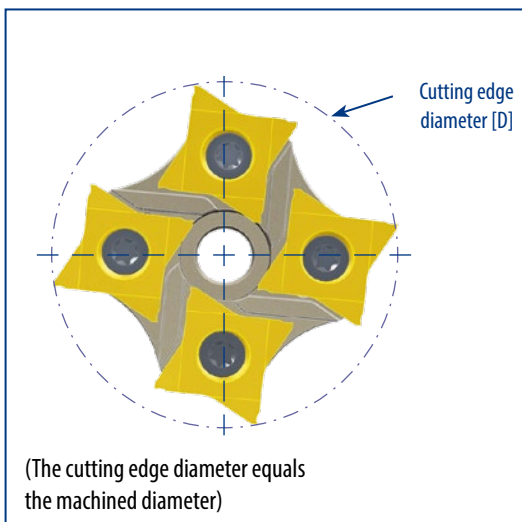
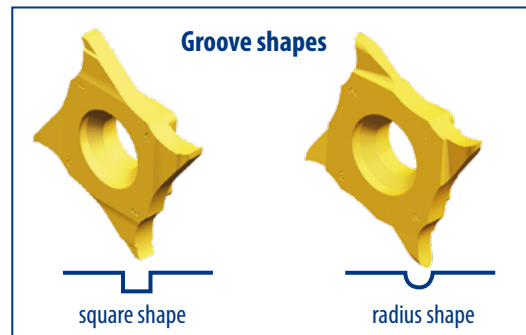
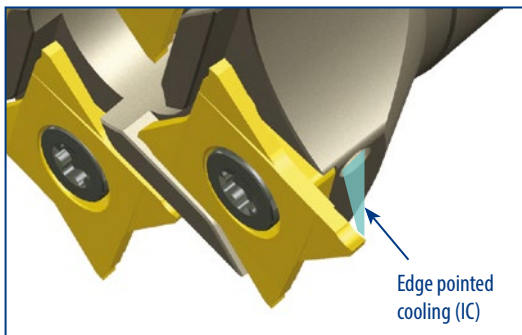
Advantages of the MULTICUT 4 System:

- ▶ Perfect power and form actuated clamping
- ▶ Reinforced insert
- ▶ Reinforced cutting edges
- ▶ High efficiency (in case, a cutting edge is damaged, all other edges can be used independently)
- ▶ Only one insert pocket size for many different cutting and turning operations

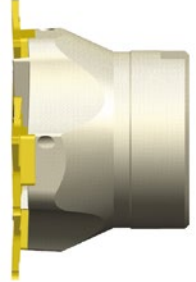

Milling heads	Shank end mills
 <p>Cutting edges (Z): 3-5 Cutting edge diameter Ø: 52 mm - 80 mm</p>	 <p>With one pocket size Cutting edges (Z): 4 Cutting edge diameter Ø: 28 mm</p>
	 <p>More than one pocket Cutting edges (Z): 3 Cutting edge diameter Ø: 52 mm</p>
<p><i>Dimension Z describes the amount of cutting edges in action. Z does not describe the amount of inserts on a milling cutter.</i></p>	

<p>Shank end mill with 1 insert All 4 cutting edges are engaged.</p> 	<p>Shank end mills D52 and milling heads D52-80 with 3-5 inserts Only one cutting edge of each insert is engaged.</p> 
---	--

Cutting inserts for shank end mills with D = 28 mm



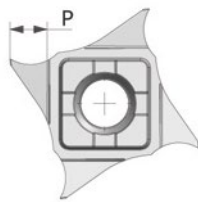
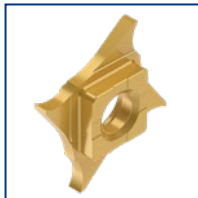

OFQ16L..P.S
Circular



Enlarged view

WG400 Ref.	KM NANOSPEED	pocket size	↻	P	R	S ±0,05
	ID-Nr.					
OFQ16L 050 010 P25 S	43091	S16	L	2,5	0,10	0,50
OFQ16L 100 010 P35 S	43092	S16	L	3,5	0,10	1,00
OFQ16L 150 015 P35 S	43093	S16	L	3,5	0,15	1,50
OFQ16L 200 015 P35 S	43094	S16	L	3,5	0,15	2,00
OFQ16L 250 015 P35 S	43095	S16	L	3,5	0,15	2,50
OFQ16L 300 015 P35 S	43096	S16	L	3,5	0,15	3,00

Fitting tools

 <p>Tech. Section</p>	 <p>pocket size</p>	 <p>Intersection (main cutting edge)</p>	 <p>Fitting tools</p>
p. 229	p. 230	p. 232	p. 53

Full radius inserts for shank end mills with D = 28 mm

OFQ16L..R..P..S

Circular

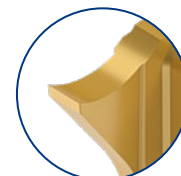
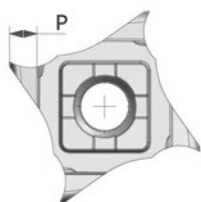





Enlarged view

WG400 Ref.	KM NANOSPEED	pocket size	()	P	R	S +0.05
	ID-Nr.					
OFQ16L 100 R050 P35 S	43110	S16	L	3,5	0,50	1,00
OFQ16L 150 R075 P35 S	43111	S16	L	3,5	0,75	1,50
OFQ16L 200 R100 P35 S	43112	S16	L	3,5	1,00	2,00
OFQ16L 250 R125 P35 S	43113	S16	L	3,5	1,25	2,50
OFQ16L 300 R150 P35 S	43114	S16	L	3,5	1,50	3,00



Application: left hand insert
Only left hand inserts fit in milling heads and shank end mills.

Fitting tools

 Tech. Section	 pocket size	 Intersection (main cutting edge)	
p. 229	p. 230	p. 232	p. 53

Precision grooving inserts for shank end mills DIN 471 D =28 mm without chamfer

OFQ16L..P..S

Circular

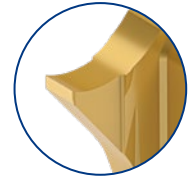
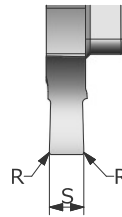
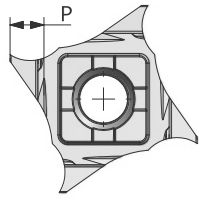
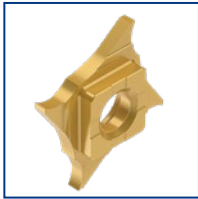

Enlarged view

WG400 Ref.	KM NANOSPEED	pocket size	(C)	P	R		S ^{-0,05}
	ID-Nr.						
OFQ16L 130 010 P35 S	43115	S16	L	3,5	0,10	1,30	1,44
OFQ16L 160 010 P35 S	43116	S16	L	3,5	0,10	1,60	1,74
OFQ16L 185 015 P35 S	43117	S16	L	3,5	0,15	1,85	1,99
OFQ16L 215 015 P35 S	43118	S16	L	3,5	0,15	2,15	2,29
OFQ16L 265 015 P35 S	43119	S16	L	3,5	0,15	2,65	2,79
OFQ16L 315 015 P35 S	43120	S16	L	3,5	0,15	3,15	3,29

Remark

Recommended for grooves to DIN 471 (external) and DIN 472 (internal).

Fitting tools



p. 229



p. 230



p. 232



p. 53

Precision grooving inserts for shank end mills DIN 471 D =28 mm with chamfer

OFQ16L..P..S

Circular

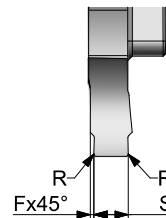
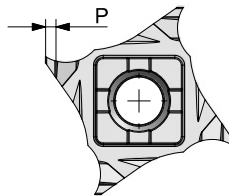
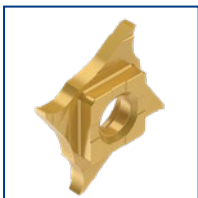

Enlarged view

WG400 Ref.	KM NANOSPEED	pocket size	(C)	F	P	R		S ^{-0,05}
	ID-Nr.							
OFQ16L 110 010 P050 S	43121	S16	L	0,15	0,50	0,10	1,10	1,24
OFQ16L 130 010 P067 S	43122	S16	L	0,15	0,67	0,10	1,30	1,44
OFQ16L 160 010 P100 S	43123	S16	L	0,15	1,00	0,10	1,60	1,74
OFQ16L 185 015 P125 S	43124	S16	L	0,20	1,25	0,15	1,85	1,99
OFQ16L 215 015 P150 S	43125	S16	L	0,20	1,50	0,15	2,15	2,29
OFQ16L 265 015 P150 S	43126	S16	L	0,20	1,50	0,15	2,65	2,79
OFQ16L 265 015 P175 S	43127	S16	L	0,20	1,75	0,15	2,65	2,79

Fitting tools



p. 229



p. 230



p. 232



p. 53

Precision inserts for milling heads and shank end mills without chamfer

OFQ16L..P..M

Circular

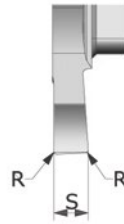
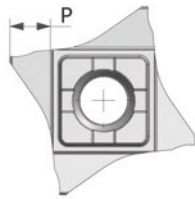

Enlarged view

WG400 Ref.	KM NANOSPEED	pocket size	(C)	P	R		S ^{-0,05}
	ID-Nr.						
OFQ16L 130 010 P55 M	43097	16	L	5,5	0,10	1,30	1,44
OFQ16L 160 010 P55 M	43098	16	L	5,5	0,10	1,60	1,74
OFQ16L 185 015 P55 M	43099	16	L	5,5	0,15	1,85	1,99
OFQ16L 215 015 P55 M	43100	16	L	5,5	0,15	2,15	2,29
OFQ16L 265 015 P55 M	43101	16	L	5,5	0,15	2,65	2,79
OFQ16L 315 015 P55 M	43102	16	L	5,5	0,15	3,15	3,29

Remark:

These inserts may as well be used with the MULTICUT 4 cutting tool holders as displayed in the GripLock catalogue.

Recommended for grooves to DIN 471 (out-side) and DIN 472 (inside).



p. 229



p. 230



p. 232



p. 43, 44



p. 45



p. 45



p. 53 - 54



p. 54



p. 193

Fitting tools

Precision inserts for milling heads and shank end mills with chamfer

OFQ16L..P..M

Circular

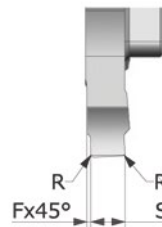
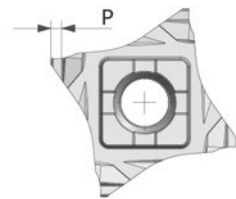

Enlarged view

WG400 Ref.	KM NANOSPEED	pocket size	(C)	F	P	R		S ^{-0,05}
	ID-Nr.							
OFQ16L 110 010 P050 M	43103	16	L	0,15	0,50	0,10	1,10	1,24
OFQ16L 130 010 P067 M	43104	16	L	0,15	0,67	0,10	1,30	1,44
OFQ16L 160 010 P100 M	43105	16	L	0,15	1,00	0,10	1,60	1,74
OFQ16L 185 015 P125 M	43106	16	L	0,20	1,25	0,15	1,85	1,99
OFQ16L 215 015 P150 M	43107	16	L	0,20	1,50	0,15	2,15	2,29
OFQ16L 265 015 P150 M	43108	16	L	0,20	1,50	0,15	2,65	2,79
OFQ16L 265 015 P175 M	43109	16	L	0,20	1,75	0,15	2,65	2,79

Remark: These inserts may as well be used with the MULTICUT 4 cutting tool holders as displayed in the GripLock catalogue. Special inserts to machine grooves to DIN 471 or DIN 472.



p. 229



p. 230



p. 232



p. 53 - 54



p. 54



p. 43, 44



p. 45



p. 45



p. 193

Fitting tools

MULTICUT 4 - Designation code for shank end mills and milling heads

System designation for GripLock rotary tools: **GLR M92 28 20 SW 16 3 04** amount of edges in action

Clamping system M92

edge diameter

shaft diameter/location whole diameter

max. cutting depth = P

Insert Type Ø 16 (pocket size)

Type of milling cutter: Slot cutter = T, milling head = M, shank end mills = S. (Additional for Weldon clamping = W) e.g.: SW = shank end mill with Weldon attachment.

Shank end mills

GLRM92 28..SW...

Circular

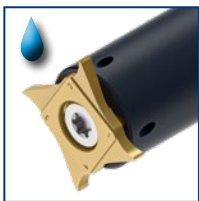

Shank end mill with one insert pocket

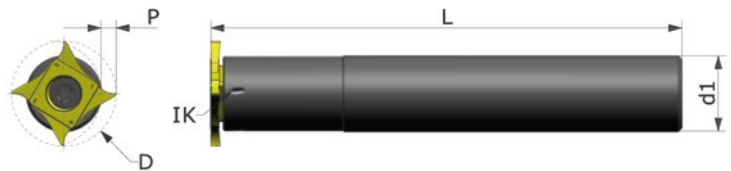

WG600 Ref.	ID-Nr.	pocket size	D	d1	Plattensitze	P	Z	d	L	
GLR M92 28 20 SW 16 3.5 04	41052	S16	28	20	1	3.5	4	-	125	35

Attention please!

On the shank end mill diameter = 28 mm only the inserts, described on page 49 - 51 will fit.

Only LH inserts fits on shank end mills and milling heads.



p. 229



p. 230



p. 49



p. 50



p. 51

Fitting inserts

GLRM92 52..SW...

Circular



Shank end mill with more than one insert pocket

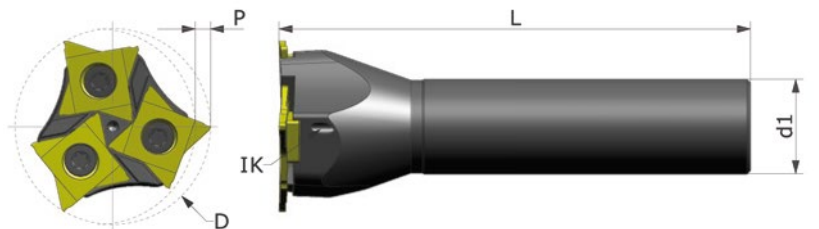

WG600 Ref.	ID-Nr.	pocket size	D	d1	Plattensitze	P	Z	d	L	
GLR M92 52 25 SW 16 3.5 03	41053	16	52	25	3	3.5	3	-	125	35



p. 229



p. 230



p. 29 - 30



p. 31



p. 32



p. 34



p. 51

Fitting inserts

Milling heads

GLRM92..M...
Circular



Milling head with 3 insert pockets

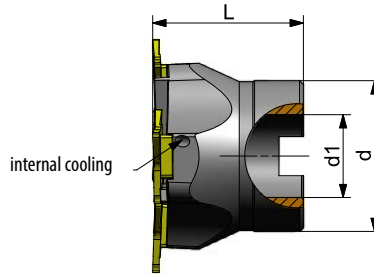
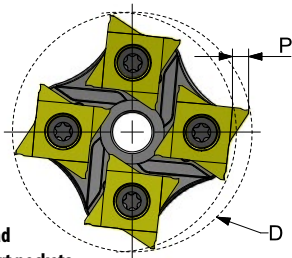

Milling head with 5 insert pockets

GLRM92..M...
Circular

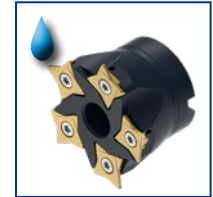

WG600 Ref.	ID-Nr.	pocket size	D	d1	Plattensitze	Pmax	Z	d	L	
GLR M92 52 16 M 16 3.5 03	41054	16	52	16	3	3.5	3	32	40	32+35
GLR M92 63 22 M 16 4.5 04	41055	16	63	22	4	4.5	4	40	40	35
GLR M92 80 27 M 16 5.5 05	41056	16	80	27	5	5.5	5	55	50	35

Example of use:
Internal milling with MC4 milling head

- 1 Milling head fixture (e.g. HSK)
- 2 Milling head MC4
- 3 Component

Attention please!

For internal milling operations, the milling head (equipped with inserts) diameter has got to be smaller than the diameter of the component.

Attention please!
Only LH inserts will fit on shank end mills and milling heads.

Fitting inserts

p. 229	p. 230	p. 29 - 30	p. 31	p. 32	p. 34	p. 51

P92 - Parting off, grooving and turning

A great variety of applications

- ▶ *Grooving*
- ▶ *Turning*
- ▶ *Parting off*
- ▶ *Hard material machining* 
- ▶ *Internal cooling* 

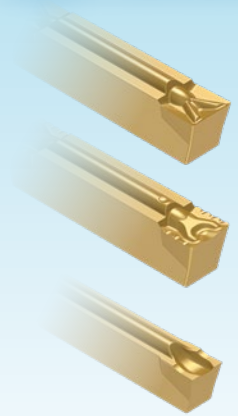

P92 - Parting off, grooving and turning

A great variety of applications

Cutting and turning machining

The major cutting edge cuts a groove and then the minor edge turns in longitudinal direction.

Different methods of cutting and turning

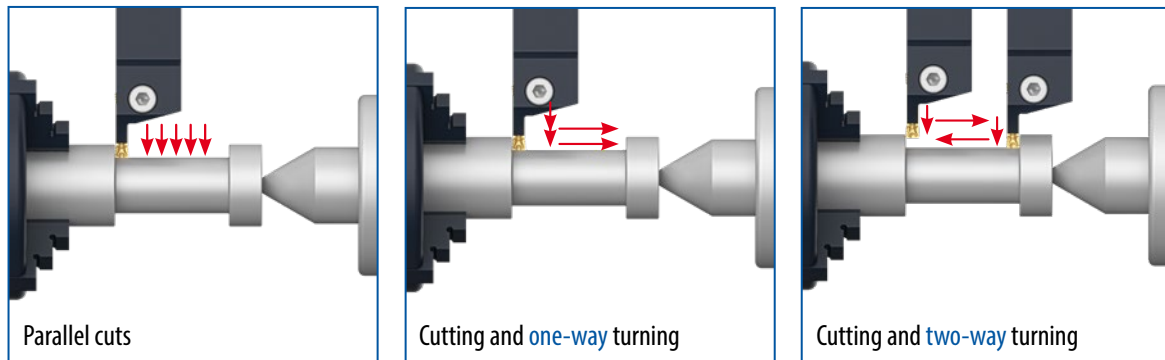

Major cutting edge

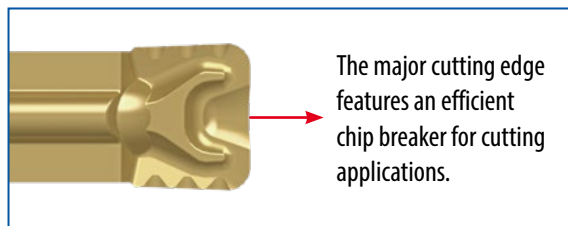

Minor cutting edge

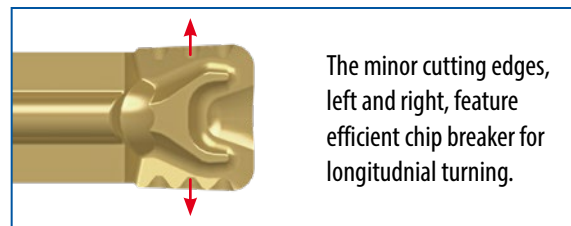

Grooving

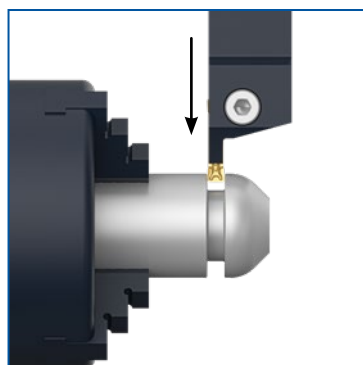

Grooving MTNS
insert with solid and rounded cutting edge.

The major cutting edge cuts a groove.

Parting off

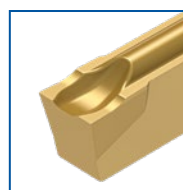

Parting off BTNN
Insert featuring a large and efficient chip breaker.

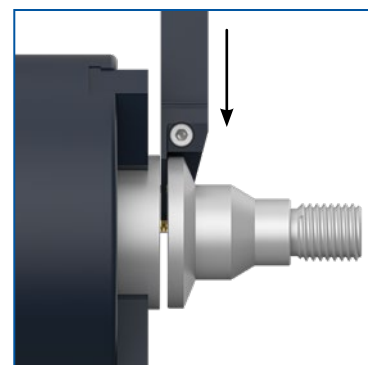

The major edge parts off a component from the bar.

P92 - Parting off, grooving and turning

A great variety of applications

The absolutely rigid clamping system

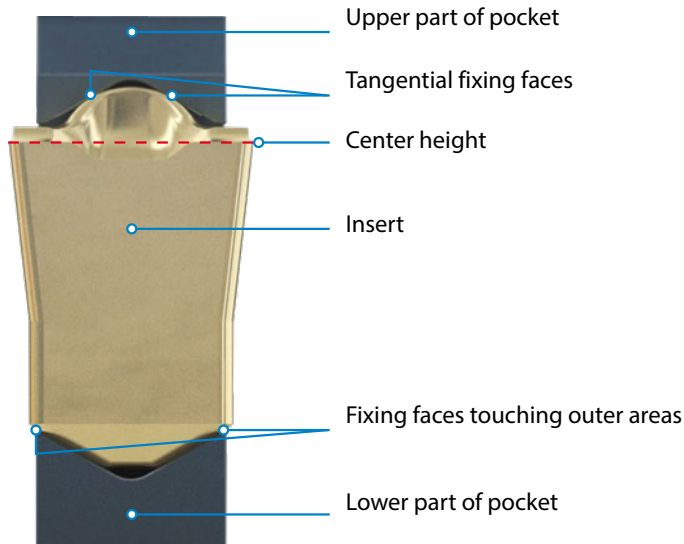

TWIN blade P92-TMS

on page 103

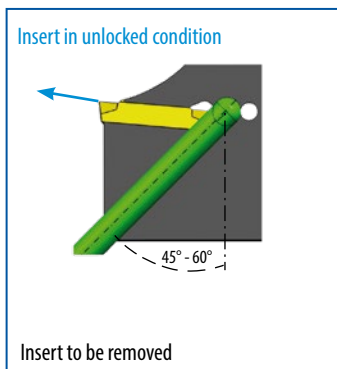
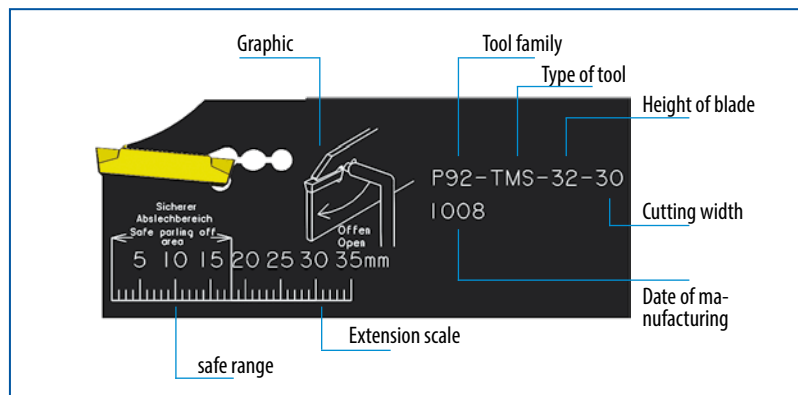
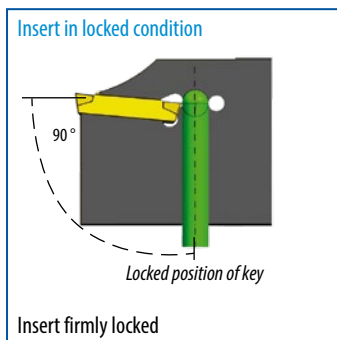

Advantages

- ✓ Increased profitability compared to blades holding 1-edge inserts
- ✓ Reinforced solidity
- ✓ Perfect clamping
- ✓ Easy handling
- ✓ Marking for easy understanding
- ✓ Excellent tool life together with parting off inserts BTNN and A BTNN
- ✓ Steady run

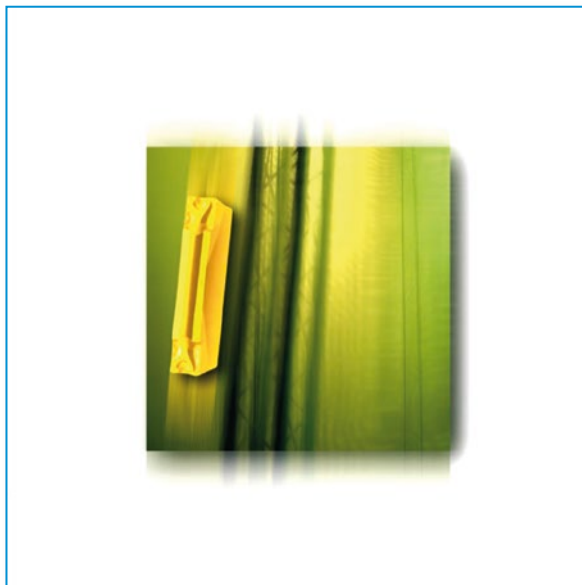

P92 - Grooving and turning

A variety of applications

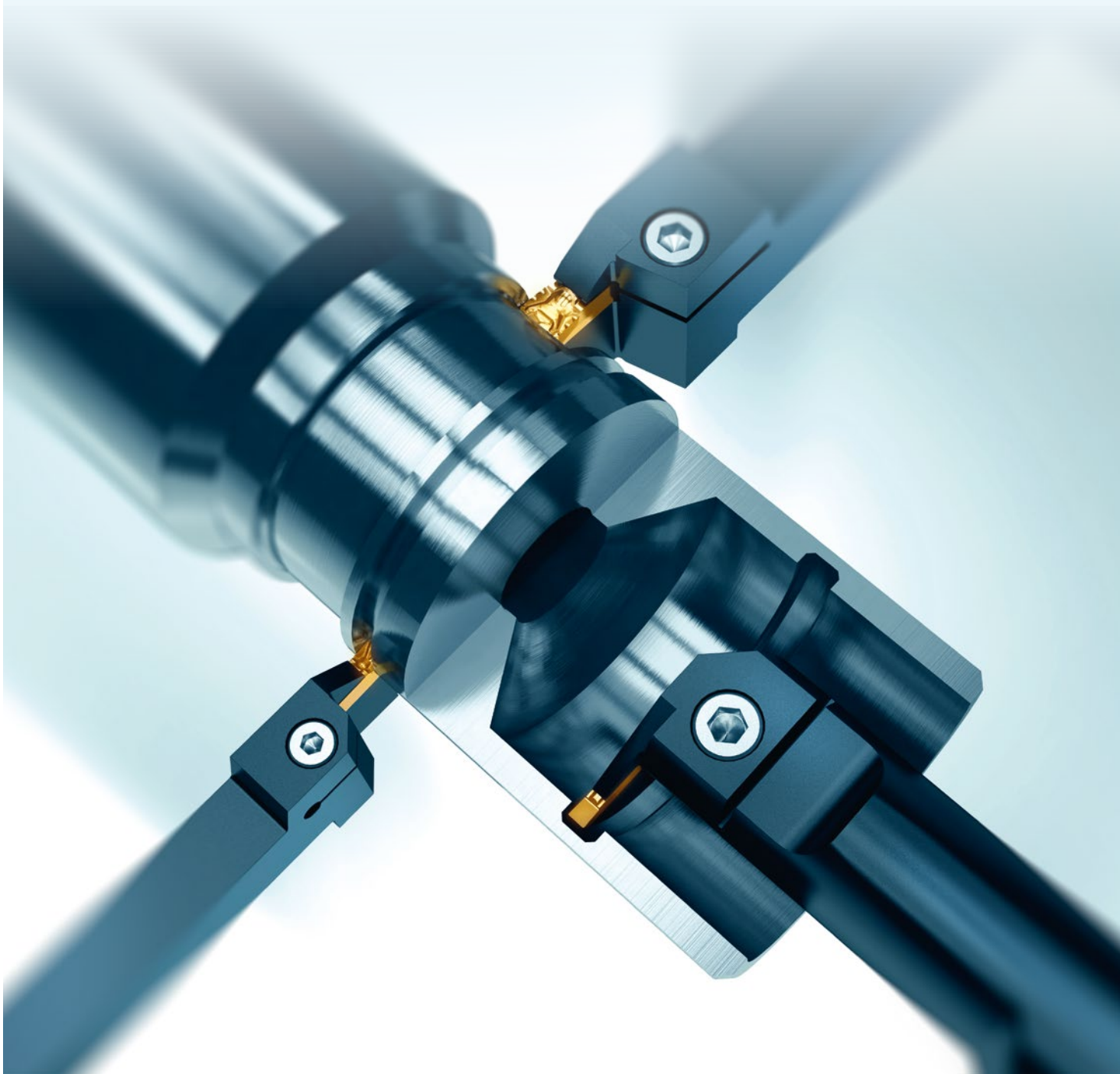

Coatings

ALOX

Coating type:
Supernitrid

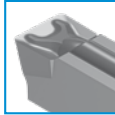

Description: Ideal coating for interrupted cuts and crusts with high wear resistance.
Application: cast iron, free cutting steel.
Layer thickness: 6 µm
Layer composition: Nanocomposite, TiAlN

AluSpeed

Coating type:
Borid



Description: High performance coating for smooth surfaces and easy chip flow.
Application: Aluminium, aluminium alloys, Titanium and non ferrous material.
Layer thickness: 2 µm
Layer composition: Monolayer

CARBOSPEED

Coating type:
Powernitrid

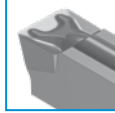

Description: Dense and hard coating layer with low residual stress. Excellent adhesive force and fine smooth surface.
Application: low and high alloy steel.
Layer thickness: 3 µm
Layer composition: Nanocomposite, TiAlCrN

CASTSPEED

Coating type:
MT-CVD
Gasphasen-
deposition

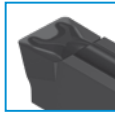

Description: Perfectly connected to the lower layers. Extremely smooth surface. Suitable for dry machining.
Application: gray cast iron, alloy gray iron, spheroidal iron and malleable cast iron.
Layer thickness: 8 µm
Layer composition: AlTiN

CASTSPEED

Coating type: **PLUS**
MT-CVD
Gasphasen-
deposition

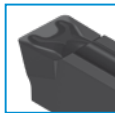

Description: very thick, smooth and wear resistant coating.
Application: gray cast iron, alloy gray iron, spheroidal iron and malleable cast iron.
Layer thickness: 22 µm
Layer composition: TiCN

Hardlox 2

Coating type:
Supernitrid



Description: Micro crystalline structure of the coating layer. Hardlox2 has been developed for hard materials with a hardness of more than 60HRC (Rockwell hardness)
Application: hardened materials.
Layer thickness: 3 µm
Layer composition: Nanocomposite AlTiN

HARDSPEED

Coating type:
Supernitrid



Description: Micro crystalline structure of the coating layer provides smooth surfaces. For machining heat resistant materials with a hardness of more than 50HRC (Rockwell hardness).
Application: heat developing materials and difficult to cut materials.
Layer thickness: 3 µm
Layer composition: Nanocomposite, AlTiN

HYPERSPEED

Coating type:
Supernitrid



Description: Extremely fine and hard layer surface. Especially suitable for machining without coolant and difficult to cut materials.
Application: difficult to cut materials and titanium.
Layer thickness: 3 µm | **Layer composition:** Nanocomposite, AlTiN

NANOSPEED

Coating type:
Supernitrid



Description: This TiN ALOX coating combines extreme hardness with high toughness. Owing to the golden colour of the coating, wearmarks can be identified more easily.
Application: tool steels and stainless steels
Layer thickness: 3 µm
Layer composition: Nanocomposite, TiAlN

TILOX

Coating type:
Supernitrid

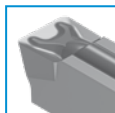

Description: The Tilox coating combines extreme hardness with high toughness and is suitable for a wide range of materials from steel to cast iron.
Application: steel, stainless steel and cast iron.
Layer thickness: 3 µm
Layer composition: Nanocomposite, TiAlN

Inserts for grooving, turning and parting off

VTNS

System P92

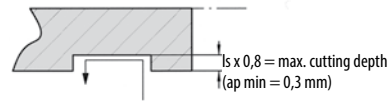
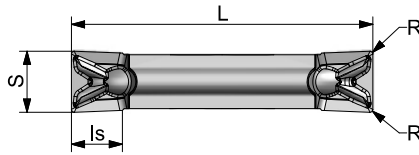

Enlarged view

WG300 Ref.	PM NANOSPEED	PM ALOX	PM TILOX	GF110 TILOX	KM TILOX	pocket size	()	L	ls	R	S
	ID-Nr.	ID-Nr.	ID-Nr.	ID-Nr.	ID-Nr.						
VTNS 302	11445	11442	11444	54743	30668	30	N	20	3,0	0,2	3,0 ^{+0,15}
VTNS 3,5	11449	11446	11448	54686	54674	40	N	20	3,0	0,2	3,55 ^{±0,035}
VTNS 402	11453	11450	11452	54689	54677	40	N	20	3,5	0,2	4,0 ^{+0,20}
VTNS 502	11457	11454	11456	54692	54682	50	N	25	4,2	0,2	5,0 ^{+0,25}

VTNS-Roughing to finishing Horizontal cutting edge with V-shaped chip breaker. Horizontal turning edges with large chip spaces to allow deep cuts. Especially recommended for carbon steels, low alloy steels and free cutting materials.

MTNS

System P92

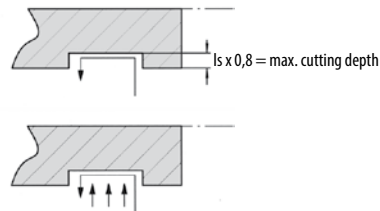
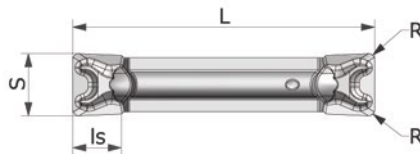

Enlarged view

WG300 Ref.	PM NANOSPEED	KM NANOSPEED	PM ALOX	KM TILOX	PM TILOX	GF110 NANOSPEED	GF110 ALOX	pocket size	()	L	ls	R	S
	ID-Nr.	ID-Nr.	ID-Nr.	ID-Nr.	ID-Nr.	ID-Nr.	ID-Nr.						
MTNS 202	54647	33879	54917	33878	54918	56957	54929	20	N	20,10	2,0	0,2	2,05 ^{+0,10}
MTNS 2,5	54649	33889	54916	33888	54919	56958	54928	20	N	20,10	2,0	0,2	2,62 ^{+0,10}
MTNS 302	11011	54618	11008	38482	11010	56959	44290	30	N	20,00	3,5	0,2	3,0 ^{+0,15}
MTNS 304	11015	54619	11012	38541	11014	44195	36063	30	N	20,00	3,5	0,4	3,0 ^{+0,15}
MTNS 402	11019	54620	11016	38542	11018	56960	44291	40	N	20,00	3,5	0,2	4,0 ^{+0,20}
MTNS 404	11023	54621	11020	38543	11022	56961	44275	40	N	20,00	3,5	0,4	4,0 ^{+0,20}
MTNS 408	21555	54622	21344	13170	43814	56962	44292	40	N	20,00	3,5	0,8	4,0 ^{+0,15}
MTNS 504	11031	54623	11028	38544	11030	56963	39451	50	N	25,00	4,2	0,4	5,0 ^{+0,25}
MTNS 508	43821	54624	43822	13413	43823	56611	44293	50	N	25,00	4,2	0,8	5,05 ^{+0,25}
MTNS 604	43827	54625	43828	19268	43829	56964	44294	60	N	30,00	4,9	0,4	6,05 ^{+0,25}
MTNS 608	21557	54626	32197	19269	40340	56965	21022	60	N	30,00	4,9	0,8	6,05 ^{+0,25}
MTNS 612	54651	54642	54912	19270	54920	56966	54930	60	N	30,00	4,9	1,2	6,05 ^{+0,25}
MTNS 808	21559	54627	28346	19271	29875	56967	54927	80	N	30,00	6,4	0,8	8,05 ^{+0,25}
MTNS 812	54653	54643	54915	19272	54921	56968	54931	80	N	30,00	6,4	1,2	8,05 ^{+0,25}
MTNS 1008	54655	54644	54913	19274	54922	56969	54932	100	N	30,00	8,1	0,8	10,05 ^{+0,25}
MTNS 1012	54657	54645	54914	19275	54923	56970	54933	100	N	30,00	8,1	1,2	10,05 ^{+0,25}

MTNS-Roughing Cutting edge with large parting off chip breakers. Excellent chip control in the range ls x 0,8. Especially recommended for carbon steels, low and high alloy steels.



Fitting tools:

Inserts for grooving and turning

MTNSG
System P92

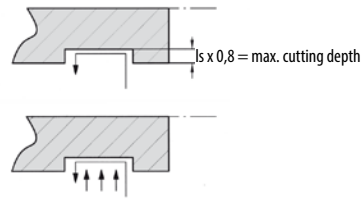
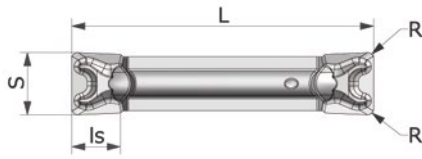

Enlarged view

WG300 Ref.	KM TILOX	pocket size	()	L	Is	R	$S_{\pm 0,025}$
MTNSG 202	49957	20	N	20,00	2,0	0,2	1,95
MTNSG 2,5	49958	20	N	20,10	2,0	0,2	2,45
MTNSG 302	49959	30	N	19,95	3,5	0,2	2,95
MTNSG 304	49960	30	N	19,95	3,5	0,4	2,95
MTNSG 402	49961	40	N	19,85	3,5	0,2	3,95
MTNSG 404	49962	40	N	19,85	3,5	0,4	3,95
MTNSG 408	49963	40	N	19,85	3,5	0,8	3,95
MTNSG 504	49964	50	N	24,85	4,2	0,4	5,00
MTNSG 508	49965	50	N	24,85	4,2	0,8	5,00
MTNSG 604	49966	60	N	29,80	4,9	0,4	6,00
MTNSG 608	49967	60	N	29,80	4,9	0,8	6,00
MTNSG 612	49968	60	N	29,80	4,9	1,2	6,00
MTNSG 808	49969	80	N	29,65	6,4	0,8	7,95
MTNSG 812	49970	80	N	29,65	6,4	1,2	7,95
MTNSG 1008	49971	100	N	29,70	8,1	0,8	9,95
MTNSG 1012	49972	100	N	29,70	8,1	1,2	9,95

MTNSG Cutting and turning chip breaker...

Circumferentially ground cutting edges slightly honed with polished top-rake.
Recommended for stainless steels, titanium, nickel alloys and aluminium alloy steels.

Easy chip flow

Low heat built-up reduces wear on the cutting edges.





Internal cooling
p. 94-106, 194



Tech. Section
p. 229



pocket size
p. 230



p. 89



p. 90 - 95



p. 96 - 98



p. 101-104



p. 105



p. 106



p. 113-116



p. 118-120



p. 121



p. 194



p. 220

Fitting tools

62 **GRIPLOCK®**

Inserts for grooving and turning

STNZ / STNG

System P92

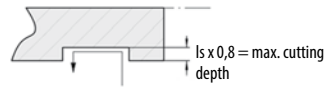
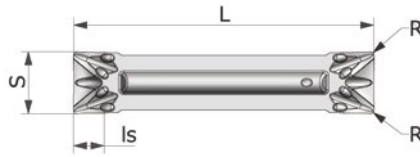

Enlarged view

WG300 Ref.	KM	KM Aluspeed	KM HYPERSPEED	KM TILOX	pocket size	(C)	L	Is	R	S
	ID-Nr.	ID-Nr.	ID-Nr.	ID-Nr.						
STNZ 504		45003	45009	45117	50	N	25,0	2,5	0,4	5,25 ±0,075
STNG 502	45014	45004	45010	45118	50	N	25,0	2,5	0,2	5,10 -0,050
STNG 504	45015	45005	45011	45119	50	N	25,0	2,5	0,4	5,10 -0,050

Comment:

STNZ/STNG has been developed, to machine materials, which are difficult to cut, like:

- nonferrous heavy metals
- nickel alloys
- plastic materials
- composite materials
- aluminium alloys

STNZ = polished surfaces, honed edges
STNG = polished surfaces, sharp cutting edges

Fitting tools

p. 94-106, 194
 p. 229
 p. 230
 p. 232
 p. 92
 p. 97
 p. 106
 p. 120
 p. 121
 p. 194

CTDS

System P92

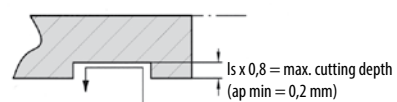
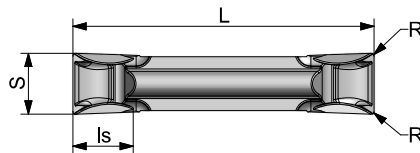

Enlarged view

WG300 Ref.	PM NANOSPEED	PM TILOX	KM TILOX	pocket size	(C)	L	Is	R	S ±0,10
	ID-Nr.	ID-Nr.	ID-Nr.						
CTDS 302	10418	10417	15318	30	N	20 ±0,15	3,0	0,2	3,075
CTDS 402	10422	10421	21412	40	N	20 ±0,15	3,0	0,2	4,075
CTDS 502	10426	10425	60278	50	N	25 ±0,20	3,0	0,2	5,125

CTDS-Super finishing

Chamfered cutting edge and sharply ground turning edges. Excellent chip control even on turning with small cutting depths.

Fitting tools

p. 94-106, 194
 p. 229
 p. 230
 p. 232
 p. 91-95
 p. 96-98
 p. 101-104
 p. 105
 p. 106
 p. 113-116
 p. 118-120
 p. 121
 p. 194
 p. 220

Inserts for grooving and turning

ETNZ
System P92

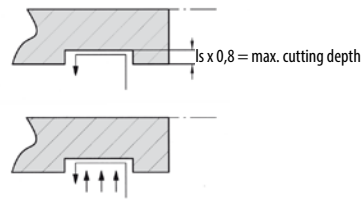
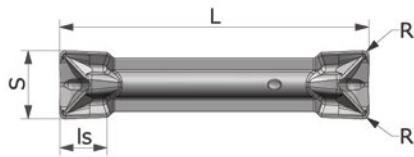

Enlarged view

WG 300 Ref.	GF110 TILOX	GF110 Hardspeed	pocket size	()	application	L ^{+/-0,20}	ls	R	S
ETNZ 3.504	54198	54199	30	N	R	20,50	3,5	0,4	3,50 ±0,075
ETNZW 3.304	54190	54193	30	N	M	20,30	3,5	0,4W	3,30 ±0,05
ETNZG 3.002	54195	54196	30	N	F	20,00	3,5	0,2	3,00 ±0,05
ETNZ 4.504	50594	50596	40	N	R	20,50	3,5	0,4	4,50 ±0,075
ETNZW 4.304	50605	50607	40	N	M	20,30	3,5	0,4W	4,30 ±0,05
ETNZG 4.002	50599	50601	40	N	F	20,00	3,5	0,2	4,00 ±0,05
ETNZ 5.504	59038	59218	50	N	R	25,50	4,2	0,4	5,50 ±0,075
ETNZW 5.304	59040	59219	50	N	M	25,30	4,2	0,4W	5,30 ±0,05
ETNZG 5.002	59042	59220	50	N	F	25,00	4,2	0,2	5,00 ±0,05
ETNZ 6.504	59039	59221	60	N	R	30,50	4,9	0,4	6,50 ±0,075
ETNZW 6.304	59041	59222	60	N	M	30,30	4,9	0,4W	6,30 ±0,05
ETNZG 6.002	59043	59223	60	N	F	30,00	4,9	0,2	6,00 ±0,05

Application comments			Profile of minor cutting edges A - A
R	Grooving, turning and parting off for difficult to cut materials.	The minor cutting edges and the radius area are marked through a zero degree chamfer x 0,2 mm. Crater wear will be reduced significantly.	
M	Grooving, turning and parting off for difficult to cut materials.	The minor cutting edges and the WIPER Edge are sharp and are marked by a stabil zero degree chamfer x 0,1 mm. The polished geometry reduce heat development and crater wear.	
F	Grooving, turning and parting off for difficult to cut materials, also for Titanium and nonferrous materials.	The minor cutting edges and the radius area are sharp. The polished geometry reduce heat development, crater wear and built-up edges.	

WIPER Geometrie

ETNZW 3.304 GF 110 TILOX and
ETNZW 4.304 GF 110 HARDSPEED

are new products in grooving and turning.

The **WIPER** geometry generates excellent surfaces in finishing quality even if you use high cutting parameters. This component was machined with $V_c = 150$ m/min and $f = 0,2 - 0,5$ mm/rev.

Economy Line products
Excellent quality at attractive prices.
Achieved with most modern manufacturing methods.

Fitting tools



Inserts for profiling

PTNSM
System P92

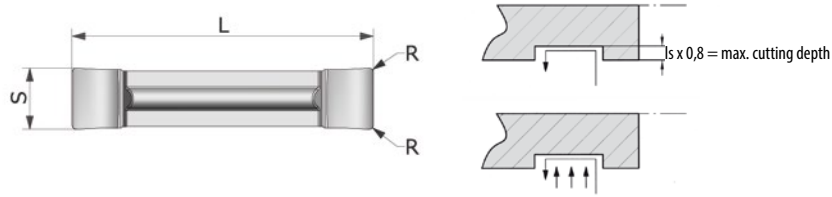

Enlarged view

WG300 Bezeichnung	GF110 TILOX ID-Nr.	pocket size	()	L	ls	R	S ±0,10
PTNSM 202	57184	20	N	20 ±0,15	0,6	0,2	2,075
PTNSM 2.502	57185	20	N	20 ±0,15	0,6	0,2	2,575
PTNSM 304	57186	30	N	20 ±0,15	0,6	0,4	3,075
PTNSM 402	57187	40	N	20 ±0,15	0,6	0,2	4,075
PTNSM 404	57188	40	N	20 ±0,15	0,6	0,4	4,075
PTNSM 504	57189	50	N	25 ±0,20	0,6	0,4	5,125
PTNSM 508	57190	50	N	25 ±0,20	0,6	0,8	5,125
PTNSM 604	57191	60	N	30 ±0,20	0,6	0,4	6,125
PTNSM 608	57192	60	N	30 ±0,20	0,6	0,8	6,125
PTNSM 808	57193	80	N	30 ±0,20	0,6	0,8	8,125
PTNSM 812	57194	80	N	30 ±0,20	0,6	1,2	8,125

High positive parting off geometry

Ground top rake with 0,1 mm chamfer on the major cutting edge for stabilisation.
Especially recommended for: NE materials and difficult to cut materials. Application: profiling.

PTNSM application

Finishing and super-finishing operation with an offset $a_p=0,2-0,5\text{mm}$ in NE- and difficult to cut materials.

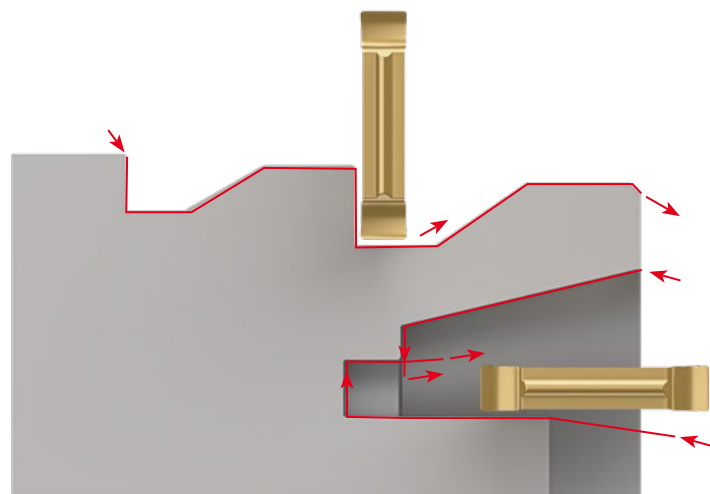

Fitting tools

p. 94-106, 194	p. 229	p. 230	p. 89	p. 90 - 95	p. 96 - 98	p. 101-104	p. 105	p. 106	p. 113-116	p. 118-120	p. 121	p. 194	p. 220

Inserts for grooving and turning

MTNZ
System P92

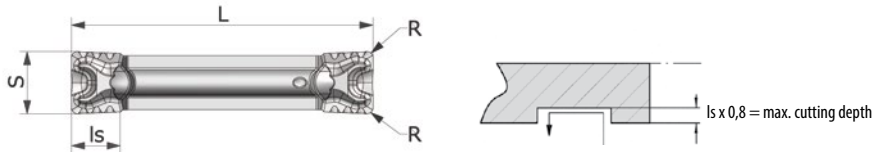

Enlarged view

WG300 Ref.	PM NANOSPEED ID-Nr.	KM NANOSPEED ID-Nr.	PM ALOX ID-Nr.	PM TILOX ID-Nr.	KM TILOX ID-Nr.	pocket size	(°)	L	Is	R	S
MTNZ 304	42791	42790	42793	42792	41018	30	N	20,00	3,5	0,4	3,075 ±0,075
MTNZ 3,5	11035	-	11032	11034	-	40	N	20,00	3,5	0,2	3,550 ±0,080
MTNZ 402	11039	15723	11036	11038	15724	40	N	20,00	3,5	0,2	4,000 ±0,200
MTNZ 404	42797	42796	42799	42798	41017	40	N	20,00	3,5	0,4	4,100 ±0,100
MTNZ 504	11043	54667	11040	11042	54668	50	N	25,00	4,2	0,4	5,000 ±0,250
MTNZ 508	42801	42800	42803	42802	41000	50	N	25,00	4,2	0,8	5,125 ±0,125
MTNZ 604	42805	42804	42807	42806	41019	60	N	30,00	4,9	0,4	6,125 ±0,125
MTNZ 608	42809	42808	42811	42810	41196	60	N	30,00	4,9	0,8	6,125 ±0,125
MTNZ 808	42814	42813	42816	42815	42812	80	N	30,00	6,4	0,8	8,125 ±0,125
MTNZ 812	42818	42817	42820	42819	41197	80	N	30,00	6,4	1,2	8,125 ±0,125

MTNZ-Roughing

Grooved cutting edge and wave shaped turning edges. Chip control even when machining high alloy steels and stainless steels.

... all operations with 1 tool holder and 1 insert ...

- Face turning
- Profiling
- Grooving
- Large groove cutting
- Roughing
- Finishing
- Chamfering
- Parting-off

How to write an order:

1 pc. P92 CXCBL 1212 K30 10 or: **1 pc. ID-Nr. 28189** **recommended**

10 pcs. MTNZ 304 PM NANOSPEED or: **10 pcs. ID-Nr. 42791**



Inserts for face grooving and parting off

GTNS
System P92

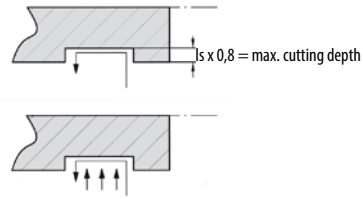
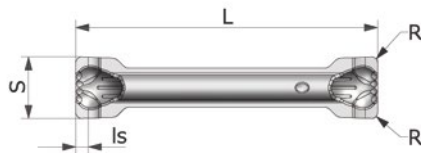

Enlarged view

WG300 Ref.	GF110 TILOX	PM TILOX	GF110 CARBOSPEED	PM CARBOSPEED	pocket size	⌀	Ls	L	R	S±0,1
	ID-Nr.	ID-Nr.	ID-Nr.	ID-Nr.						
GTNS 302	57238	57239	57240	57241	30	N	1,5	20±0,15	0,2	3,075
GTNS 404	55940	57242	57243	57244	40	N	1,5	20±0,15	0,4	4,075
GTNS 504	40195	40194	48309	48310	50	N	1,5	25±0,2	0,4	5,125

Chip breaker:

Especially developed for effective chip flow when face grooving.

Insert:

Developed for machining of stainless and alloyed steels.

Clearance:

Especially for face grooving.

Remark:

To be used as well for radial grooving and **parting off**.

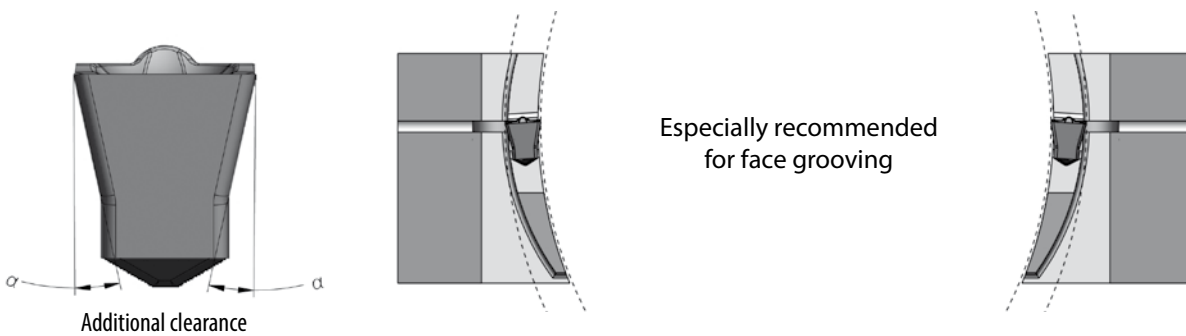

Face grooving



Grooving



Parting off

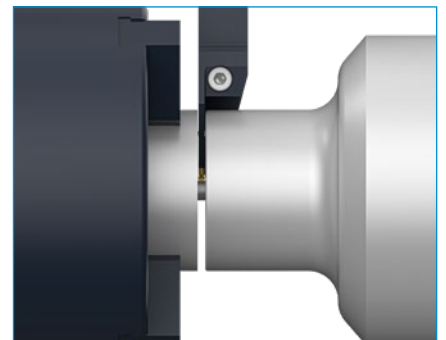

Economy Line products
Excellent quality at attractive prices.
Achieved with most modern manufacturing methods.

Fitting tools

p. 94-106, 194	p. 229	p. 230	p. 232	p. 91-95	p. 96-98	p. 101-104	p. 105	p. 106	p. 113-116	p. 118-120	p. 121	p. 194	p. 220

Inserts for copying and turning

XTNS
System P92

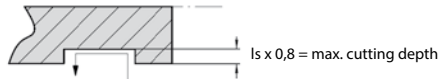
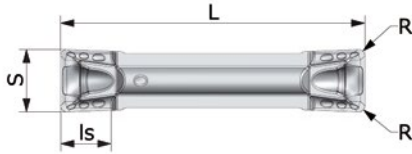

Enlarged view

WG300 Ref.	Economy Line products		GF110 TILOX ID-Nr.	pocket size	⌀	L	Is	R	S
	KM TILOX ID-Nr.	PM Nanospeed ID-Nr.							
XTNS 202	14268	60205*	38917	20	N	20,15	2,00	0,2	2,05 +0,10
XTNS 302	14055	60206*	38918	30	N	20,15	3,00	0,2	3,05 +0,15
XTNS 304	14053	60207*	38919	30	N	20,15	3,00	0,4	3,05 +0,15
XTNS 404	38903	60208*	38920	40	N	20,15	3,40	0,4	4,05 +0,15
XTNS 408	38904	60209*	38921	40	N	20,15	3,40	0,8	4,05 +0,15
XTNS 504	38905	60210*	54696	50	N	25,15	4,20	0,4	5,05 +0,25
XTNS 508	38906	60211*	54699	50	N	25,15	4,20	0,8	5,05 +0,25
XTNS 604	38910	60212*	54701	60	N	30,10	4,50	0,4	6,05 +0,25
XTNS 608	38911	60213*	54702	60	N	30,10	4,50	0,8	6,05 +0,25
XTNS 612	38912	60214*	54703	60	N	30,10	4,50	1,2	6,05 +0,25
XTNS 808	38913	60215*	54704	80	N	30,10	6,00	0,8	8,05 +0,25
XTNS 812	38914	60216*	54705	80	N	30,10	6,00	1,2	8,05 +0,25
XTNS 1008	38915	60217*	54706	100	N	30,10	6,00	0,8	10,05 +0,25
XTNS 1012	38916	60218*	54669	100	N	30,10	6,10	1,2	10,05 +0,25

*Available from 01.06.2020

XTNS - Roughing to finishing

A 9° declining major cutting edge with a reinforcing chamfer and a 24° positive entry to the chip former, achieve excellent chip control especially on difficult to cut materials. The minor cutting edges with 16° positive entry angle achieve efficient profile turning creating clean surfaces. Although the insert has been developed for universal cutting and turning, parting off tests with KM TILOX proved excellent tool life on stainless steels, e.g. 1.4404 (X2 CrNiMo1810). Therefore the insert is also recommended for stainless steel parting off. The best tool life on parting off hexagon material 1.4571 Ø 38 has been 409 pcs so far. This could be increased to an amazing 678 pcs with the same speeds. (Vc: 60 m/min; f: 0,05 mm/Rev.)



Economy Line products

Excellent quality at attractive prices.
Achieved with most modern manufacturing methods.



p. 94-106, 194 p. 229 p. 230 p. 89 p. 90 - 95 p. 96 - 98 p. 101-104 p. 105 p. 106 p. 113-116 p. 118-120 p. 121 p. 194 p. 220

Inserts for grooving and turning

BTNG

System P92

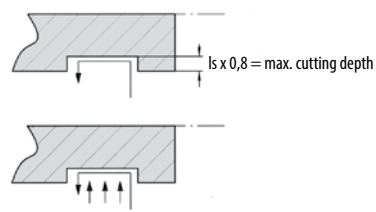

Enlarged view

WG260 Ref.	GF110 ID-Nr.	GF110 NANOSPEED ID-Nr.	GF110 TILOX ID-Nr.	pocket size	(C)	L	ls	R	S ±0,025
BTNG 202	32649	34264	34263	20	N	20,00	2,00	0,2	2,00
BTNG 2,5	32652	34005	34004	20	N	20,00	2,00	0,2	2,50
BTNG 302	13403	13404	-	30	N	20,00	3,50	0,2	3,00
BTNG 304	13405	13406	-	30	N	20,00	3,50	0,4	3,00
BTNG 402	13407	13408	-	40	N	20,00	3,50	0,2	4,00
BTNG 404	13409	13410	-	40	N	20,00	3,50	0,4	4,00
BTNG 408	13411	13412	-	40	N	20,00	3,50	0,8	4,00
BTNG 504	13402	13124	-	50	N	25,00	4,20	0,4	5,00
BTNG 508	13396	13395	-	50	N	25,00	4,20	0,8	5,00
BTNG 604	19292	20502	-	60	N	30,00	4,90	0,4	6,00
BTNG 608	19293	20503	-	60	N	30,00	4,90	0,8	6,00
BTNG 808	19294	20504	-	80	N	30,00	6,40	0,8	8,00
BTNG 812	19295	20505	-	80	N	30,00	6,40	1,2	8,00
BTNG 1008	19296	20506	-	100	N	30,00	8,10	0,8	10,00
BTNG 1012	19297	20507	-	100	N	30,00	8,10	1,2	10,00

BTNG-Finishing Grooved cutting edge. Horizontal turning edges with parallel chip breakers. The **precision ground micrograin insert** is recommended especially for heat resistant alloys.

Fitting tools, see below

BTNX

System P92

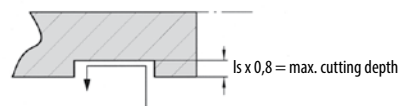
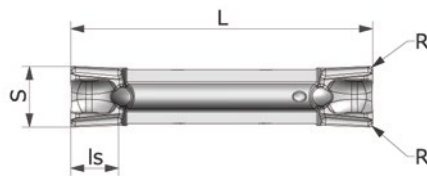

Enlarged view

WG300 Ref.	GS 530 NANOSPEED ID-Nr.	KM TILOX ID-Nr.	pocket size	(C)	L	ls	R	S
BTNX 202	32658	38825	20	N	20,10	2,00	0,2	2,05 +0,10
BTNX 2,5	32661	38824	20	N	20,10	2,00	0,2	2,62 +0,10
BTNX 302	12669	38826	30	N	20,00	3,50	0,2	3,05 +0,15
BTNX 304	12687	38827	30	N	20,00	3,50	0,4	3,05 +0,15
BTNX 404	12691	38828	40	N	20,00	3,50	0,4	4,05 +0,15
BTNX 408	12686	38829	40	N	20,00	3,50	0,8	4,05 +0,15
BTNX 504	12692	38830	50	N	25,00	4,20	0,4	5,05 +0,25
BTNX 508	12685	38831	50	N	25,00	4,20	0,8	5,05 +0,25

BTNX-Semi finishing

Grooved cutting edge. Horizontal turning edges with parallel chip breakers. The **TIN-coated cermet insert** is recommended for high speed finishing. The insert can be used universally. The grade **KM TILOX** is recommended for semi finishing to roughing machining.

Fitting tools



Inserts for grooving and turning

OTXC
System P92

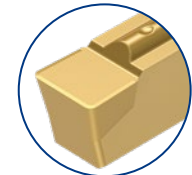
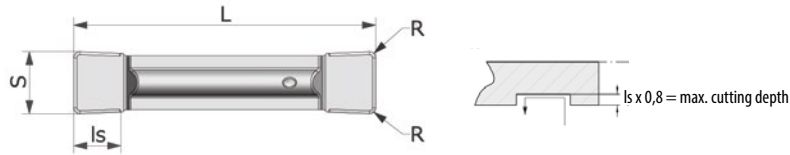

Enlarged view

WG300 Ref.	GF110 CASTSPEED plus	KM CASTSPEED	pocket size	(C)	L	ls	R	S ±0,10
	ID-Nr.	ID-Nr.						
OTXC 304	56299	52919	30	N	20 ±0,15	3,5	0,4	3,08
OTXC 402	56298	52920	40	N	20 ±0,15	3,5	0,2	4,08
OTXC 404	56297	52921	40	N	20 ±0,15	3,5	0,4	4,08
OTXC 504	56296	52922	50	N	25 ±0,20	4,2	0,4	5,13
OTXC 508	56295	52923	50	N	25 ±0,20	4,2	0,8	5,13
OTXC 604	56294	52924	60	N	30 ±0,20	6,4	0,4	6,13
OTXC 608	56293	52925	60	N	30 ±0,20	6,4	0,8	6,13
OTXC 808	54290	52926	80	N	30 ±0,20	6,4	0,8	8,13
OTXC 812	54291	52927	80	N	30 ±0,20	6,4	1,2	8,13

OTXC ... KM Castspeed

This insert has a ground top rake, a ground negative chamfer on the cutting edge and a slightly honed cutting edge. The insert has a CVD thin layer (10-12µm) and is especially recommended for unstable cast materials with interrupted cuts.

OTXC ... GF110 Castspeed plus

Precision sintered insert with negative chamfer. The insert has a CVD thick layer (20-22µm) and is especially recommended for cast materials with interrupted cuts.



Economy Line products
Excellent quality at attractive prices.
Achieved with modern manufacturing methods.

Inserts for grooving and turning

OTXS
System P92

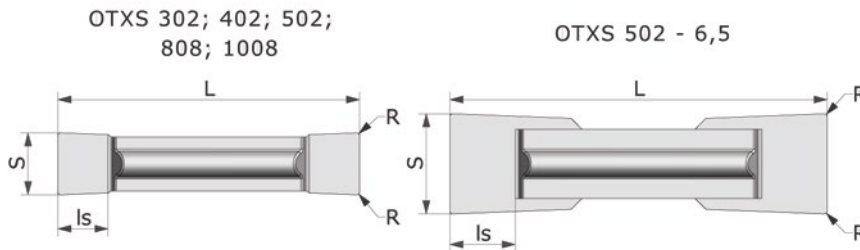
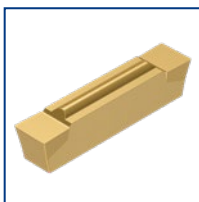

Enlarged view

WG300 Ref.	PM	KM	pocket size	(C)	L	ls	R	S
	ID-Nr.	ID-Nr.						
OTXS 302	11199	11198	30	N	20	3,5	0,2	3,0 ^{+0,15}
OTXS 402	11201	11200	40	N	20	3,5	0,2	4,0 ^{+0,20}
OTXS 502	11203	11202	50	N	25	4,2	0,2	5,0 ^{+0,25}
OTXS 502 6,5	11205	11204	50	N	25	4,9	0,2	6,5 ^{+0,25}
OTXS 808	-	20544	80	N	30	6,4	0,8	8,05 ^{+0,25}
OTXS 1008	-	20543	100	N	30	8,1	0,8	10,05 ^{+0,25}

OTXS-Semi finishing

Ground top rake with 0° rake angle. Recommended for cast materials and for **customers applications**.



Inserts for copying and turning

RTNG

System P92

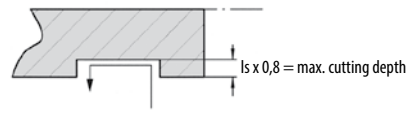
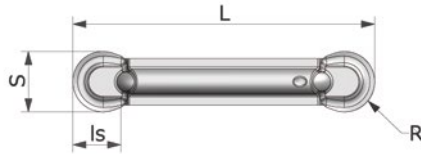

Enlarged view

WG260 Ref.	GF 110 ID-Nr.	GF 110 NANOSPEED ID-Nr.	pocket size	(C)	L	ls	R	S ±0,025
RTNG 210	34649	34650	20	N	20,00	1,71	1,0	2,00
RTNG 315	19302	20471	30	N	20,00	2,60	1,5	3,00
RTNG 420	13415	12681	40	N	20,00	3,40	2,0	4,00
RTNG 525	13416	13417	50	N	25,00	4,10	2,5	5,00
RTNG 630	19303	20508	60	N	30,00	4,90	3,0	6,00
RTNG 840	19304	20509	80	N	30,00	6,50	4,0	8,00
RTNG 1050	19310	20510	100	N	30,00	8,10	5,0	10,00

RTNG-Finishing

Precision ground full radius insert. Horizontal cutting edge with parallel chip breaker. The **micrograin** insert is especially recommended for heat resistant alloys.



Fitting tools

RTNX

System P92

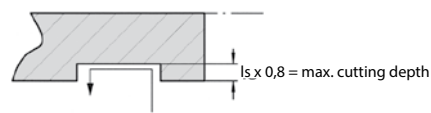
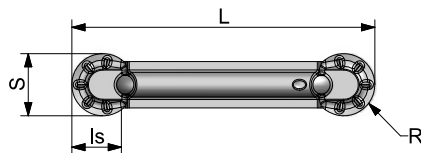

Enlarged view

WG300 Ref.	KM TILOX ID-Nr.	pocket size	(C)	L	ls	R	S
RTNX 210	31706	20	N	20,10	1,76	1,1	2,05 +0,10
RTNX 315	19298	30	N	20,00	2,60	1,5	3,05 +0,15
RTNX 420	13067	40	N	20,00	3,40	2,0	4,05 +0,15
RTNX 525	13414	50	N	25,00	4,10	2,5	5,05 +0,25
RTNX 630	19299	60	N	30,00	4,90	3,0	6,05 +0,25
RTNX 840	19300	80	N	30,00	6,50	4,0	8,05 +0,25
RTNX 1050	19301	100	N	30,00	8,10	5,0	10,05 +0,25

RTNX-Roughing

Full radius insert. The horizontal cutting edge with its chip breaker rips makes short chips on almost all materials.



Fitting tools

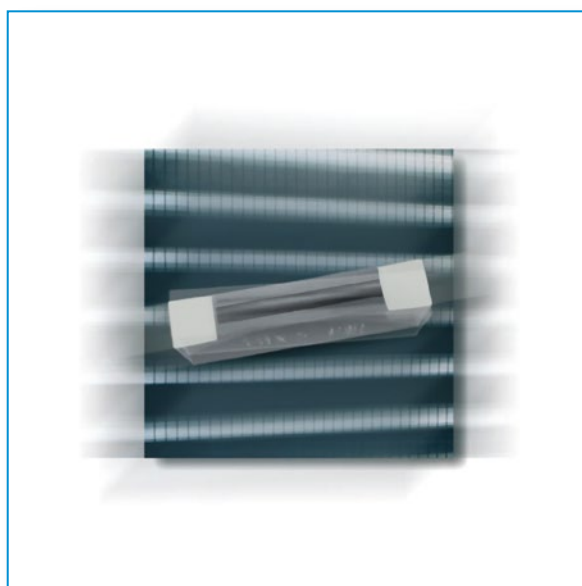
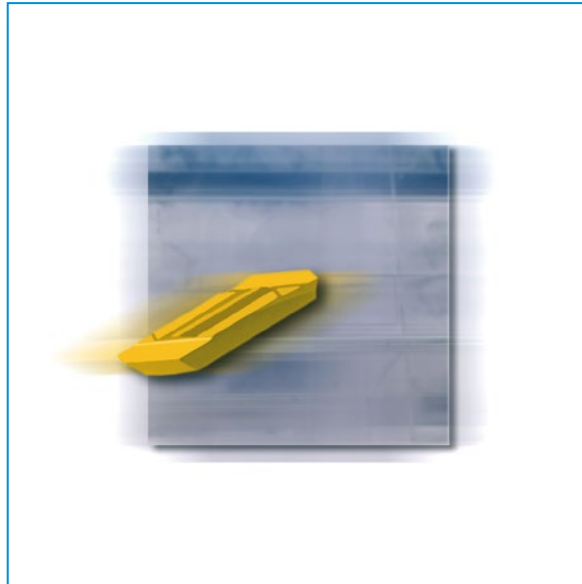

P92 - Parting off and grooving

A variety of applications

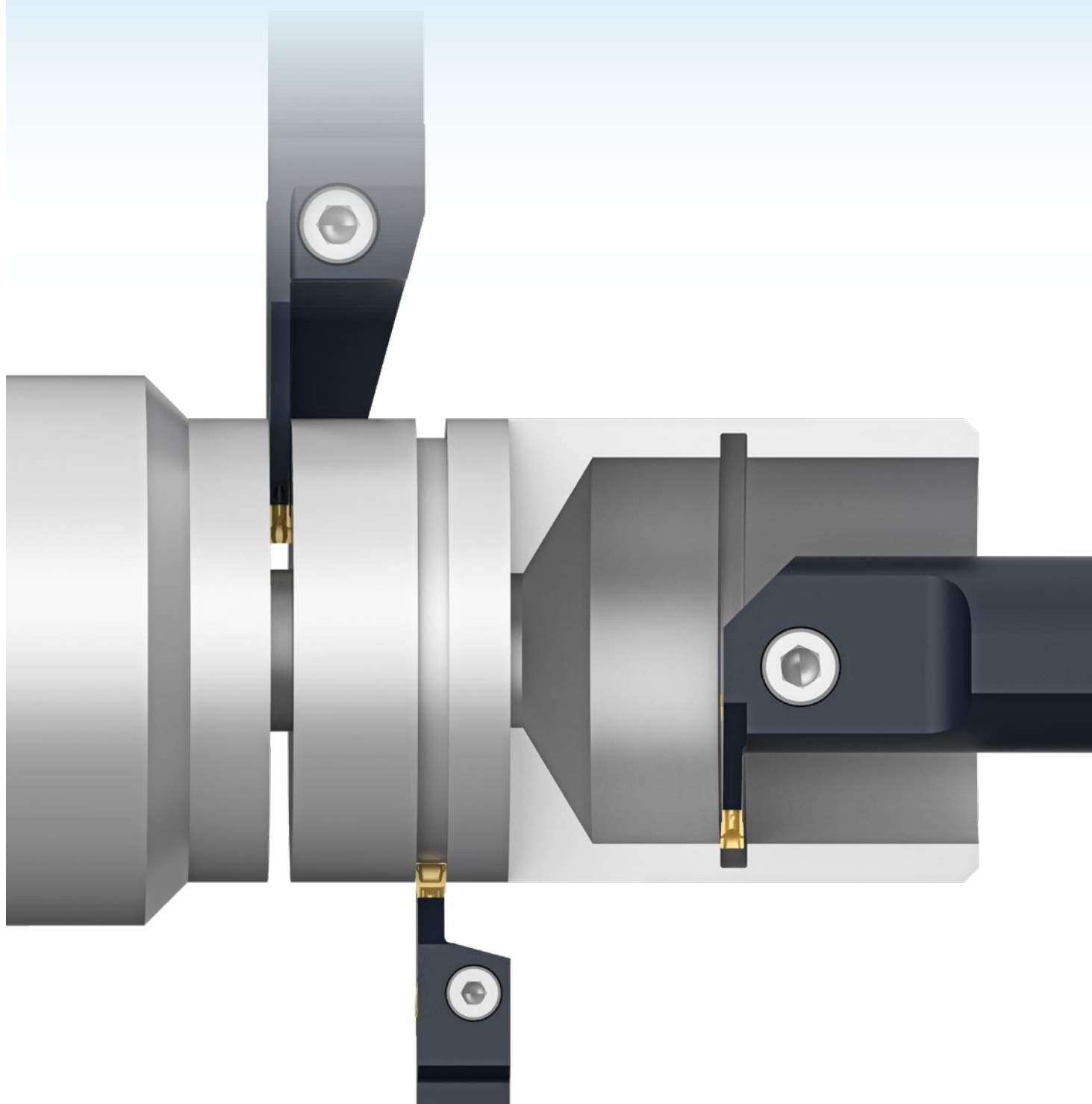

Parting off and grooving inserts with 2 edges

BTNN/R/L
System P92

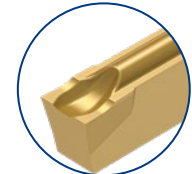
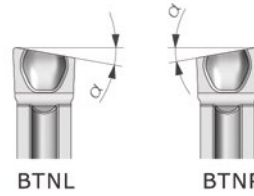
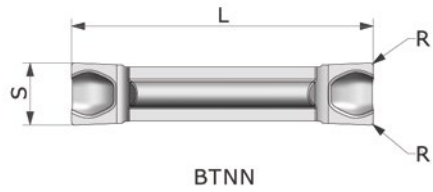

Enlarged view

WG300 Ref.	KM NANO-SPEED	PM NANO-SPEED	KM TILOX	PM TILOX	KM CARBO-SPEED	GS 530 NANO-SPEED	pocket size		L ±0,10	R	S ±0,10	
	ID-Nr.	ID-Nr.	ID-Nr.	ID-Nr.	ID-Nr.	ID-Nr.						α°
BTNN 1,5	-	45058	30595	-	43845	43561	15	N	15,50	0,2	1,575	0
BTNN 2	34208	45059	30944	-	43846	-	20	N	20,00	0,2	2,075	0
BTNN 2,5	33999	45060	30850	-	43847	-	20	N	20,00	0,2	2,575	0
BTNN 3	-	20532	12689	20917	43848	-	30	N	20,00	0,2	3,075	0
BTNN 4	-	20533	15843	30597	43849	-	40	N	20,00	0,2	4,075	0
BTNR 1,5 6D	-	45061	30576	-	43850	-	15	R	15,50	0,2	1,575	6
BTNR 1,5 10D	-	45062	30666	-	43852	-	15	R	15,50	0,2	1,575	10
BTNR 1,5 16D	-	45063	30667	-	43854	-	15	R	15,50	0,2	1,575	16
BTNR 2 6D	34210	45064	34209	-	43855	-	20	R	20,00	0,2	2,075	6
BTNR 2 10D	34207	45065	34206	-	43856	-	20	R	20,00	0,2	2,075	10
BTNR 2,5 6D	34003	45066	34002	-	43857	-	20	R	20,00	0,2	2,575	6
BTNR 2,5 10D	34001	45067	34000	-	43858	-	20	R	20,00	0,2	2,575	10
BTNR 3 6D	-	20534	12690	-	43859	-	30	R	20,00	0,2	3,075	6
BTNR 3 10D	-	20536	19665	-	43860	-	30	R	20,00	0,2	3,075	10
BTNR 4 6D	-	20538	15844	-	43861	-	40	R	20,00	0,2	4,075	6
BTNR 4 10D	-	20540	19667	-	43864	-	40	R	20,00	0,2	4,075	10
BTNL 1,5 6D	-	45068	30665	-	43866	-	15	L	15,50	0,2	1,575	6
BTNL 1,5 10D	-	45069	30663	-	43867	-	15	L	15,50	0,2	1,575	10
BTNL 1,5 16D	-	45070	30664	-	43869	-	15	L	15,50	0,2	1,575	16
BTNL 2 6D	33994	45071	33993	-	43870	-	20	L	20,00	0,2	2,075	6
BTNL 2 10D	34205	45072	34204	-	43871	-	20	L	20,00	0,2	2,075	10
BTNL 2,5 6D	33996	45073	33995	-	43872	-	20	L	20,00	0,2	2,575	6
BTNL 2,5 10D	33998	45074	33997	-	43873	-	20	L	20,00	0,2	2,575	10
BTNL 3 6D	-	20535	12688	-	43874	-	30	L	20,00	0,2	3,075	6
BTNL 3 10D	-	20537	19666	-	43875	-	30	L	20,00	0,2	3,075	10
BTNL 4 6D	-	20539	15845	-	43877	-	40	L	20,00	0,2	4,075	6
BTNL 4 10D	-	20541	19668	-	43879	-	40	L	20,00	0,2	4,075	10

BTN Parting off chip breaker

Grooved parting off edge with reinforced flanks. The deep and spacious chip-trough gives excellent chip control. Efficient on almost all materials.

Fitting tools



p. 94-106, 194 p. 229 p. 230 p. 232 p. 88-89 p. 90-92 p. 94-98 p. 101-104 p. 105 p. 106 p. 113-116 p. 118-119 p. 121 p. 194 p. 220

Parting off and grooving inserts with special surface preparation and cutting edge honing

BTNN
System P92

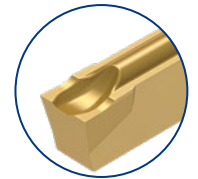
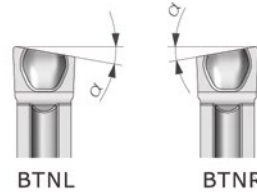
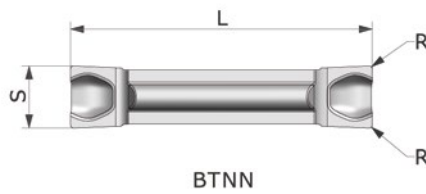

Enlarged view

WG300 Ref.	GF110	GF110	GF110	GF110	pocket size	⌀	L ±0,10	R	S ±0,10	α°
	Carbospeed	Nanospeed	Hyperspeed	Hardspeed						
	ID-Nr.	ID-Nr.	ID-Nr.	ID-Nr.						
BTNN 1,5	45075	45076	45077	47696	15	N	15,50	0,2	1,575	0
BTNN 2	45078	45079	45080	47697	20	N	20,00	0,2	2,075	0
BTNN 2,5	45081	45082	45083	47698	20	N	20,00	0,2	2,575	0
BTNN 3	42824	42825	42826	47699	30	N	20,00	0,2	3,075	0
BTNN 4	45085	45086	45087	47700	40	N	20,00	0,2	4,075	0
BTNL 1,5 7D	49098	49108	-	47711	15	L	15,50	0,2	1,575	7
BTNL 2 7D	49099	49109	-	47712	20	L	20,00	0,2	2,075	7
BTNL 2,5 7D	49100	49110	-	47713	20	L	20,00	0,2	2,575	7
BTNL 3 7D	49101	49111	-	47714	30	L	20,00	0,2	3,075	7
BTNL 4 7D	49102	49112	-	47715	40	L	20,00	0,2	4,075	7
BTNR 1,5 7D	49093	49103	-	47706	15	R	15,50	0,2	1,575	7
BTNR 2 7D	49094	49104	-	47707	20	R	20,00	0,2	2,075	7
BTNR 2,5 7D	49095	49105	-	47708	20	R	20,00	0,2	2,575	7
BTNR 3 7D	49096	49106	-	47709	30	R	20,00	0,2	3,075	7
BTNR 4 7D	49097	49107	-	47710	40	R	20,00	0,2	4,075	7



Economy Line products
Excellent quality at attractive prices.
Achieved with most modern manufacturing methods.



p. 94-106, 194 p. 229 p. 230 p. 232 p. 88-89 p. 90-92 p. 94-98 p. 101-104 p. 105 p. 106 p. 113-116 p. 118-119 p. 121 p. 194 p. 220

Fitting tools

Parting off and grooving inserts

BTNNF/RF/LF

System P92

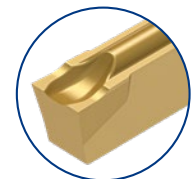
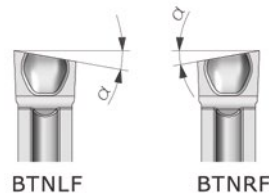
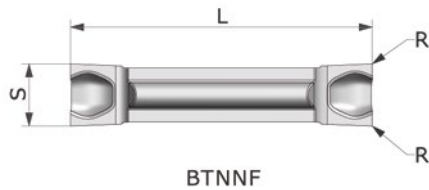

Enlarged view

WG300 Ref.	GF 110 NANOSPEED ID-Nr.	PM NANOSPEED	GF 110 CARBOSPEED ID-Nr.	pocket size	()	L ^{0,1}	R	S ±0,1	α°
BTNNF1,5	48311	54586	49647	15	N	15,10	0,0	1,575	0
BTNNF 2	48312	54589	49648	20	N	19,60	0,0	2,075	0
BTNNF 2,5	49633	54590	49649	20	N	19,60	0,0	2,575	0
BTNNF 3	49634	54591	49650	30	N	19,60	0,0	3,075	0
BTNRF1,5 6D	48313	54592	49651	15	R	15,10	0,0	1,575	6
BTNRF1,5 10D	49635	54593	49652	15	R	15,10	0,0	1,575	10
BTNRF 2 6D	48314	54594	49653	20	R	19,60	0,0	2,075	6
BTNRF 2 10D	49636	54595	49654	20	R	19,60	0,0	2,075	10
BTNRF 2,5 6D	49637	54596	49655	20	R	19,60	0,0	2,575	6
BTNRF 2,5 10D	49638	54597	49656	20	R	19,60	0,0	2,575	10
BTNRF 3 6D	49639	54598	49657	30	R	19,60	0,0	3,075	6
BTNRF 3 10D	49640	54599	49658	30	R	19,60	0,0	3,075	10
BTNLF 1,5 6D	48315	54600	49659	15	L	15,10	0,0	1,575	6
BTNLF 1,5 10D	49641	54601	49660	15	L	15,10	0,0	1,575	10
BTNLF 2 6D	48316	54602	49661	20	L	19,60	0,0	2,075	6
BTNLF 2 10D	49642	54603	49662	20	L	19,60	0,0	2,075	10
BTNLF 2,5 6D	49643	54604	49663	20	L	19,60	0,0	2,575	6
BTNLF 2,5 10D	49644	54605	49664	20	L	19,60	0,0	2,575	10
BTNLF 3 6D	49645	54606	49665	30	L	19,60	0,0	3,075	6
BTNLF 3 10D	49646	54607	49666	30	L	19,60	0,0	3,075	10

Remark: Sharply ground cutting edge without corner radius. Recommended for automatic lathe cutting jobs.

Type BTNN

Corner radius

Type BTNNF

Sharp edge without radius

The difference BTNN and BTNNF:
 F marks an especially sharp edge.
 This is recommended for hard and tough materials and also for machining steels.

The way towards the center isn't easy at all:
 When beginning the operation all conditions are ideal:

- cutting speed (Vc)
- cooling and
- chip removal

BTN Parting off chip breaker
 Grooved parting off edge with reinforced flanks. The deep and spacious **chip-trough** gives excellent chip control. Efficient on almost all materials.



Parting off and grooving inserts with 2 edges

CTD/R/L-ALU

System P92

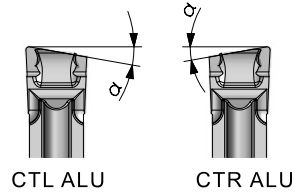
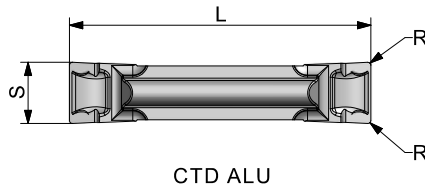

Enlarged view

WG300 Ref.	KM ID-Nr.	PM NANOSPEED ID-Nr.	KM ALUSPEED ID-Nr.	pocket size	()	L	R	S ±0,10	α°
CTD 1,5 ALU	-	54957	54960	15	N	15,5 ±0,15	0,2	1,575	0
CTD 2 ALU	-	54958	54983	20	N	20 ±0,15	0,2	2,075	0
CTD 2,5 ALU	-	54959	54984	20	N	20 ±0,15	0,2	2,575	0
CTD 3 ALU	10400	10402	10709	30	N	20 ±0,15	0,2	3,075	0
CTD 4 ALU	10405	10407	30661	40	N	20 ±0,15	0,2	4,075	0
CTD 5 ALU	10410	10412	38483	50	N	25 ±0,20	0,2	5,125	0
CTL 3 6D ALU	-	10432	30662	30	L	20 ±0,15	0,2	3,075	6
CTL 4 6D ALU	-	10444	36195	40	L	20 ±0,15	0,2	4,075	6
CTL 5 6D ALU	-	10456	10454	50	L	25 ±0,20	0,2	5,125	6
CTR 3 6D ALU	-	10431	30598	30	R	20 ±0,15	0,2	3,075	6
CTR 4 6D ALU	-	10443	38484	40	R	20 ±0,15	0,2	4,075	6
CTR 5 6D ALU	-	10455	10453	50	R	25 ±0,20	0,2	5,125	6

ALU chip breaker...

Horizontal ground cutting edge. The flat chip chamber conveys chips at high speed.

Recommended for: nonferrous heavy metals, machining steels, thinwalled parts, unstable components and pipes.

Fitting tools

p. 94-106, 194	p. 229	p. 230	p. 232	p. 88-89	p. 90-92	p. 94-98	p. 101-104	p. 105	p. 106	p. 113-116	p. 118-119	p. 121	p. 194	p. 220	

Parting off and grooving inserts with 2 edges

CTD R/L-IT
System P92

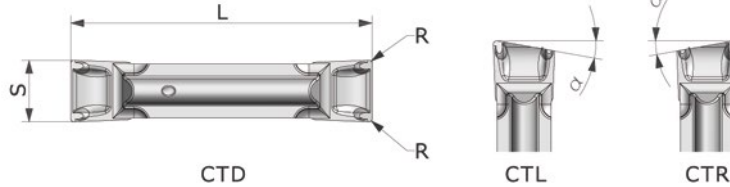

Enlarged view

WG300 Ref.	GF110 NANOSPEED ID-Nr.	PM NANOSPEED ID-Nr.	PM TILOX ID-Nr.	GF110 CARBOSPEED ID-Nr.	PM CARBOSPEED ID-Nr.	Plattensitzgröße	⌀	L	R	S ±0,10	α°
CTD 1,5	49973	49974	50204	49975	49976	15	N	15,5 ±0,15	0,15	1,58	0
CTD 2	49977	49978	50207	49979	49980	20	N	20 ±0,15	0,2	2,08	0
CTD 2,5	49981	49982	50209	49983	49984	20	N	20 ±0,15	0,2	2,58	0
CTD 3	54827	10404	10403	54828	50210	30	N	20 ±0,15	0,2	3,08	0
CTD 4	54829	10409	10408	54830	50211	40	N	20 ±0,15	0,2	4,08	0
CTD 5	54832	10414	10413	54833	50212	50	N	25 ±0,20	0,2	5,13	0
CTL 1,5 6D	49985	49986	50213	49987	49988	15	L	15,5 ±0,15	0,15	1,58	6
CTL 2 6D	49989	49990	50214	49991	49992	20	L	20 ±0,15	0,2	2,08	6
CTL 2,5 6D	49993	49994	50215	49995	49996	20	L	20 ±0,15	0,2	2,58	6
CTL 3 6D	54834	10438	10436	54835	50219	30	L	20 ±0,15	0,2	3,08	6
CTL 4 6D	54836	10450	10448	54837	50220	40	L	20 ±0,15	0,2	4,08	6
CTL 5 6D	54838	10462	10460	54839	50221	50	L	25 ±0,20	0,2	5,13	6
CTR 1,5 6D	49997	49998	50216	49999	50000	15	R	15,5 ±0,15	0,15	1,58	6
CTR 2 6D	50001	50002	50217	50003	50004	20	R	20 ±0,15	0,2	2,08	6
CTR 2,5 6D	50005	50006	50218	50007	50008	20	R	20 ±0,15	0,2	2,58	6
CTR 3 6D	54840	10437	10435	54841	50222	30	R	20 ±0,15	0,2	3,08	6
CTR 4 6D	54842	10449	10447	54843	50223	40	R	20 ±0,15	0,2	4,08	6
CTR 5 6D	54844	10461	10459	54845	50224	50	R	25 ±0,20	0,2	5,13	6

IT Classic chip breaker... Horizontal, chamfered parting off edge with reinforced flanks and large chip breaker. To be used universally and especially on interrupted cuts. Alloy steels, stainless steels, interrupted cuts.

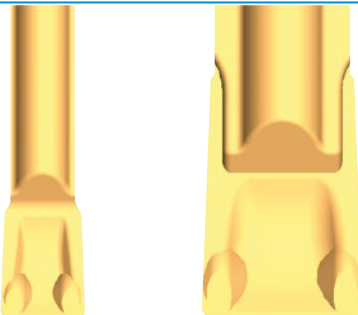

The cost cutters

Application of small width save an enormous amount of material, costs and energy.

Fitting tools



p. 94-106, 194 p. 229 p. 230 p. 232 p. 88-89 p. 90-92 p. 94-98 p. 101-104 p. 105 p. 106 p. 113-116 p. 118-119 p. 121 p. 194 p. 220

Parting off inserts

SCTD/R/L
System P92

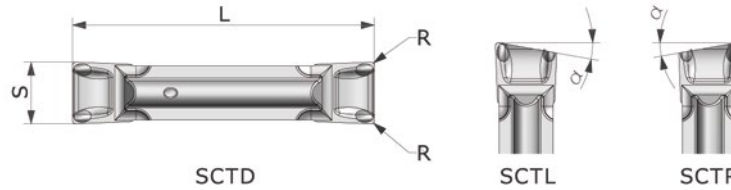

Enlarged view

WG300 Ref.	GF110 NANO-SPEED	KM NANO-SPEED	PM NANO-SPEED	GF110 CARBO-SPEED	KM CARBO-SPEED	PM CARBO-SPEED	pocket size	⌀	L	R	S ±0,10	α°
	ID-Nr.	ID-Nr.	ID-Nr.	ID-Nr.	ID-Nr.	ID-Nr.						
SCTD 1,5	50009	-	50010	50011	-	50012	15	N	15,5 ±0,15	0,2	1,58	0
SCTD 2	50013	-	50014	50015	-	50016	20	N	20 ±0,15	0,2	2,08	0
SCTD 2,5	50017	-	50018	50019	-	50020	20	N	20 ±0,15	0,2	2,58	0
SCTD 3,0	59226	53868	53869	59229	53870	53871	30	N	20 ±0,15	0,2	3,08	0
SCTD 4,0	59227	53875	53876	59230	53877	53878	40	N	20 ±0,15	0,2	4,08	0
SCTD 5,0	59228	53879	53880	59231	53881	53882	50	N	25 ±0,20	0,2	5,13	0
SCTL 1,5 6D	50021	-	50022	50023	-	50024	15	L	15,5 ±0,15	0,2	1,58	6
SCTL 2 6D	50025	-	50026	50027	-	50028	20	L	20 ±0,15	0,2	2,08	6
SCTL 2,5 6D	50029	-	50030	50031	-	50032	20	L	20 ±0,15	0,2	2,58	6
SCTL 3,0 6D	59232	53883	53884	59233	53885	53886	30	L	20 ±0,15	0,2	3,08	6
SCTR 1,5 6D	50033	-	50034	50035	-	50036	15	R	15,5 ±0,15	0,2	1,58	6
SCTR 2 6D	50037	-	50038	50039	-	50040	20	R	20 ±0,15	0,2	2,08	6
SCTR 2,5 6D	50041	-	50042	50043	-	50044	20	R	20 ±0,15	0,2	2,58	6
SCTR 3,0 6D	59234	53887	53888	59235	53889	53890	30	R	20 ±0,15	0,2	3,08	6

SUPERNOVA Parting off geometry...

Slightly honed cutting edge with reinforced flanks and large chip through.



Economy Line products

Excellent quality at attractive prices. Achieved with most modern manufacturing methods.

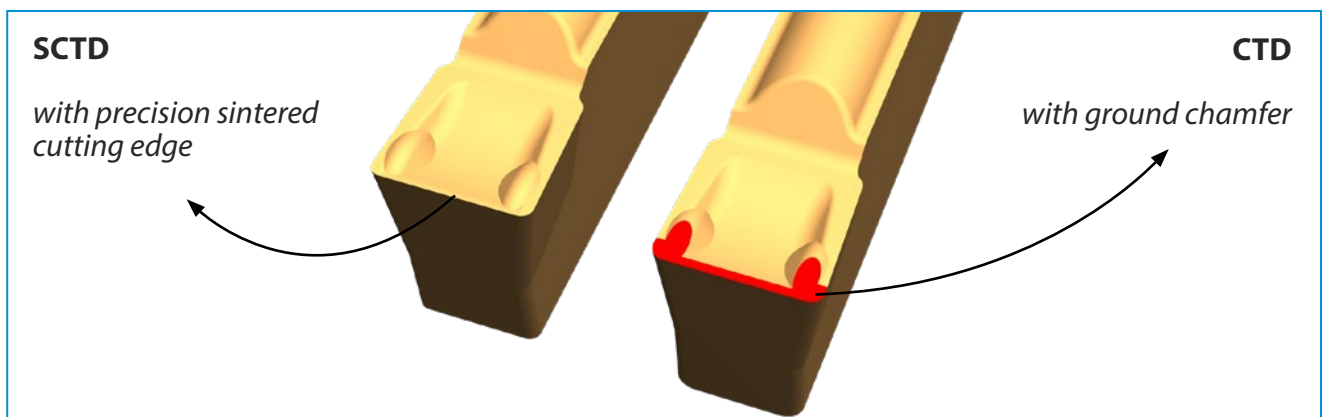

p. 94-106, 194



p. 229



p. 230



p. 88 - 89



p. 90 - 94



p. 96 - 98



p. 101-104



p. 105



p. 106



p. 113-116



p. 118



p. 194



p. 220

Fitting tools

Parting off inserts

LTNN
System P92

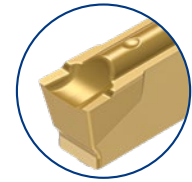
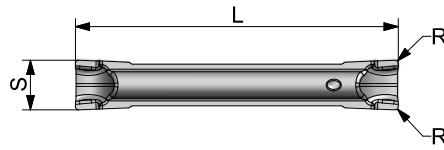

Enlarged view

WG300 Ref.	GF110 NANOSPEED	PM NANOSPEED	PM CARBOSPEED	GF110 CARBOSPEED	pocket size	⌀	L	R	S ^{+0,10}	α°
	ID-Nr.	ID-Nr.	ID-Nr.	ID-Nr.						
LTNN 1.5	55647	55980	55982	55979	15	N	16	0,15	1,50	0
LTNN 2	55975	55976	55978	55977	20	N	20	0,2	2,00	0
LTNN 3	54443	54441	54442	54444	30	N	20	0,2	3,075	0
LTNNW 3	57177	57176	-	-	30	N	20	0,2	3,075	0

LTN parting off geometry...

For parting off long chipping materials.
Especially recommended for double-spindle lathes.



WIPER Edges Description on p. 64



Economy Line products

Excellent quality at attractive prices.
Achieved with most modern manufacturing methods.

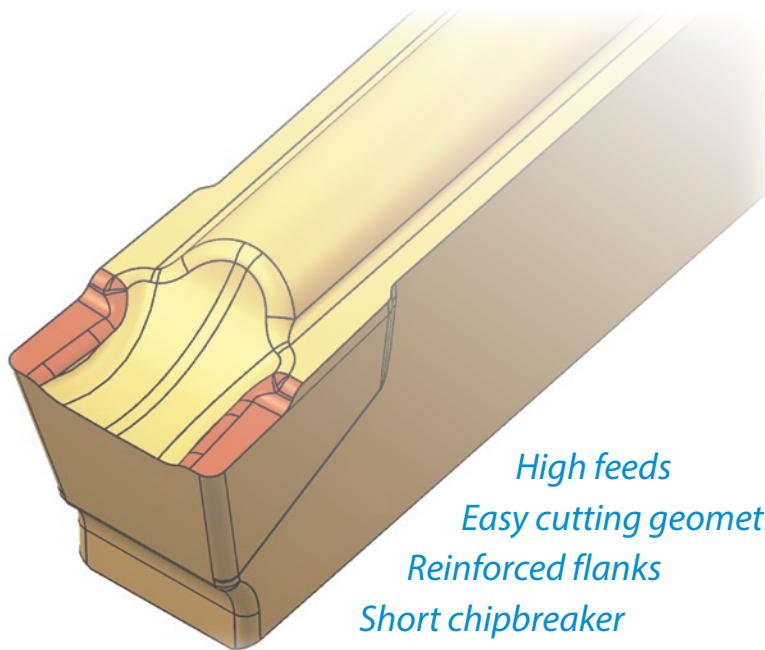

High feeds
Easy cutting geometry
Reinforced flanks
Short chipbreaker

Fitting tools

p. 94-106, 194	p. 229	p. 230	p. 88-89	p. 90-94	p. 96-98	p. 101-104	p. 105	p. 106	p. 113-116	p. 118	p. 194	p. 220

Parting off inserts for deep cuts with one edge

A GTNS
System P92

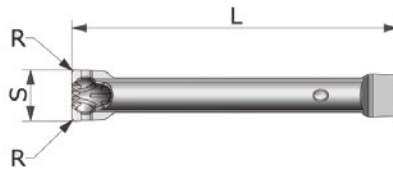

Enlarged view

WG300 Ref.	GF110 TILOX ID-Nr.	PM NANOSPEED ID-Nr.	pocket size	()	L ^{±0,15}	R	S ^{+0,15}
A GTNS 302	57229	57231	3.0	N	20,00	0,2	3,075
A GTNS 404	57230	57232	4.0	N	20,00	0,4	4,075
A GTNS 504	48472	48474	5.0	N	25,00	0,4	5,130

Fitting tools, see below

A BTNN
System P92

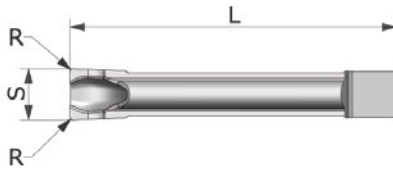

Enlarged view

WG300 Ref.	GF110 TILOX ID-Nr.	PM NANOSPEED ID-Nr.	pocket size	()	L ^{±0,15}	R	S ^{+0,15}
A BTNN 3	13953	24050	30	N	20,00	0,2	3,075
A BTNN 4	20291	24051	40	N	20,00	0,2	4,075

Fitting tools, see below

BTN-insert, type with one cutting edge. Deep cutting depth and clean turning faces. Reduce feed while cutting depth increases. Grooved parting off edge with reinforced flanks. The deep and spacious chip-trough gives excellent chip control. Efficient on almost all materials.

A CTD
System P92

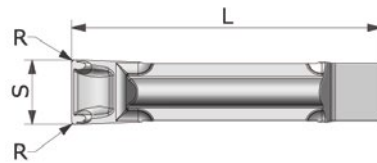

Enlarged view

WG300 Ref.	KM TILOX ID-Nr.	PM NANOSPEED ID-Nr.	pocket size	()	L ^{±0,15}	R	S ^{+0,10}
A CTD 3	10980	10983	30	N	20,00	0,2	3,08
A CTD 4	10985	10988	40	N	20,00	0,2	4,08

Fitting tools



Internal cooling p. 98-104

Tech. Section p. 229

pocket size p. 230

p. 91-94

p. 96-98

p. 101-104

p. 105

p. 106

p. 113

p. 118-120

p. 121

p. 194

p. 220

Parting off inserts for deep cuts with one edge

A SCTD
System P92

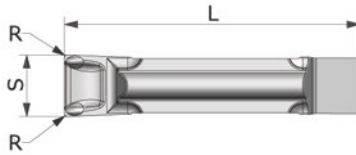

Enlarged view

WG300 Ref.	KM TILOX ID-Nr.	PM NANOSPEED ID-Nr.	pocket size	()	L±0,15	R	S+0,10
A SCTD 3	57233	57234	30	N	20,00	0,2	3,08
A SCTD 4	57235	57236	40	N	20,00	0,2	4,08



Economy Line products
Excellent quality at attractive prices.
Achieved with most modern manufacturing methods.



Remark P92 A - inserts with 1 edge

P92 A-inserts and P92 A CXCB...holder join together forming an extremely solid unit owing to long guide surfaces between insert and pocket and reinforced tool holders. A-type tools are therefore recommended for heavy duty cutting, deep cuts and to achieve clean faces.

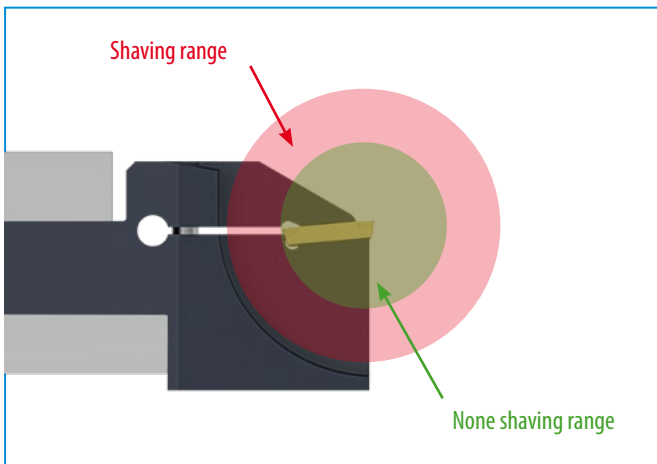

Shaving
If the cutting depth exceeds the length of the cutting insert, the second edge of the insert penetrates into the slot and may cause shaving marks on the component. To prevent from shaving the insert type A is recommended.

Fitting tools



Hard material machining



*Inserts, coating and tool holders
for parting off, grooving and turning*

Inserts with efficient chip breakers and special coating HARDLOX 2[®] for:

- ▶ *hardened materials*
- ▶ *machining hardened materials*
- ▶ *exotic and tempered materials*

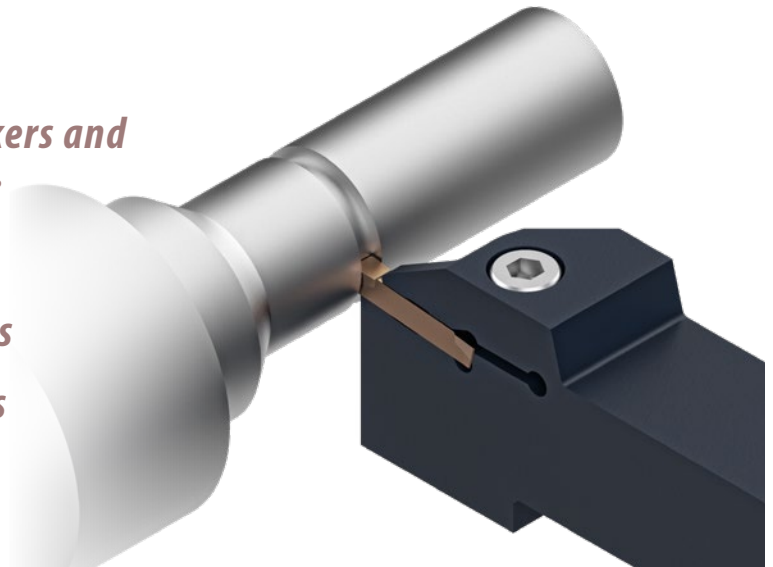

Machining materials with a Rockwell hardness of 54 and more. Inserts and holders are stressed heavily on such operations. Therefore starting-up speeds, feeds and depths should be low graded.

HARDLOX 2[®]



- Polished edges and surfaces
- Low price alternative compared with CBN tipped inserts
- To be used on unhardened steels as well
- Multi edge inserts available
- Constant performance when cutting from hard layer into soft core

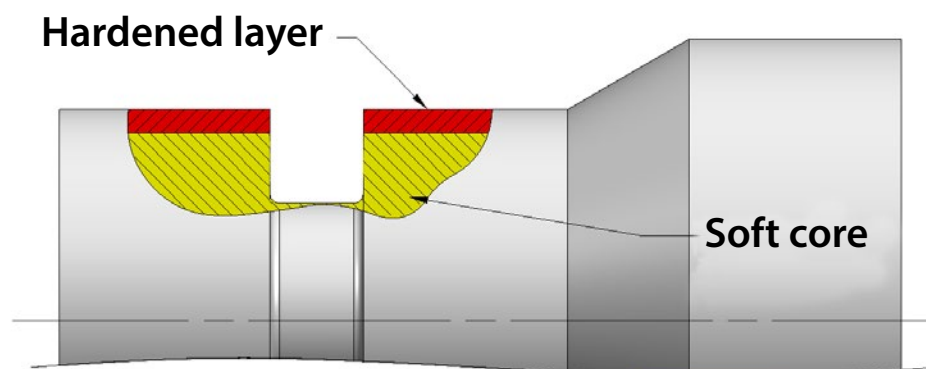

Remark: Other inserts with HARDLOX 2[®] on request.

Cutting and turning inserts | Hard material machining

BTNG
System P92

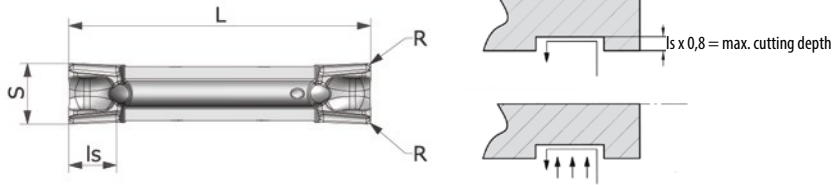

Enlarged view

WG262 Ref.	GF110 Hardlox 2 ID-Nr.	pocket size	(C)	L	ls	R	S ±0,025
BTNG 202	38751	20	N	20,00	2,00	0,2	2,00
BTNG 302	38752	30	N	20,00	3,50	0,2	3,00
BTNG 304	38753	30	N	20,00	3,50	0,4	3,00
BTNG 402	54891	40	N	20,00	3,50	0,2	4,00
BTNG 404	54892	40	N	20,00	3,50	0,4	4,00
BTNG 408	54893	40	N	20,00	3,50	0,8	4,00
BTNG 504	38754	50	N	25,00	4,20	0,4	5,00
BTNG 508	54894	50	N	25,00	4,20	0,8	5,00
BTNG 604	54895	60	N	30,00	4,90	0,4	6,00
BTNG 808	38755	80	N	30,00	6,40	0,8	8,00

Fitting tools, see below

MTNS
System P92

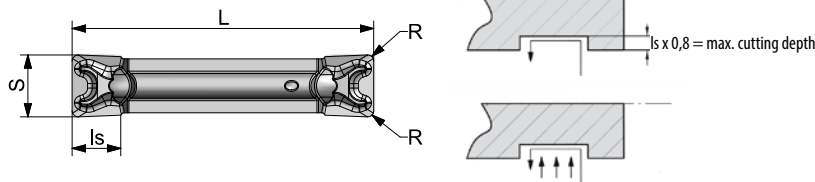

Enlarged view

WG302 Ref.	KM Hardlox 2 ID-Nr.	pocket size	(C)	L	ls	R	S
MTNS 202	38745	20	N	20,10	2,0	0,2	2,05 ^{+0,10}
MTNS 302	48392	30	N	20,00	3,5	0,2	3,00 ^{+0,15}
MTNS 304	54934	30	N	20,00	3,5	0,4	3,00 ^{+0,15}
MTNS 402	54935	40	N	20,00	3,5	0,2	4,00 ^{+0,20}
MTNS 404	54936	40	N	20,00	3,5	0,4	4,0 ^{+0,20}
MTNS 408	54937	40	N	20,00	3,5	0,8	4,0 ^{+0,15}
MTNS 504	54938	50	N	25,00	4,2	0,4	5,0 ^{+0,25}
MTNS 508	40999	50	N	25,00	4,2	0,8	5,05 ^{+0,25}
MTNS 604	54939	60	N	30,00	4,9	0,4	6,05 ^{+0,25}
MTNS 808	38750	80	N	30,00	6,4	0,8	8,05 ^{+0,25}

Fitting tools



p. 94-106, 194 p. 229 p. 230 p. 89 p. 90 - 95 p. 96 - 98 p. 101-104 p. 105 p. 106 p. 113-116 p. 118-120 p. 121 p. 194 p. 220

Cutting and turning inserts | Hard material machining

RTNG
System P92

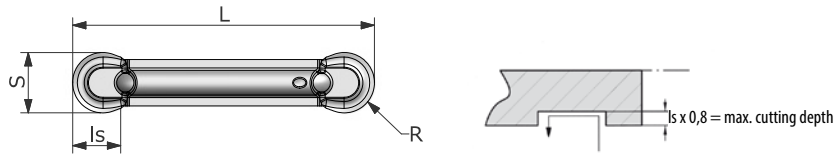

Enlarged view

WG262 Ref.	GF110 Hardlox 2 ID-Nr.	pocket size	(C)	L	ls	R	S ±0,025
RTNG 210	38756	20	N	20,00	1,71	1,0	2,00
RTNG 315	38757	30	N	20,00	2,60	1,5	3,00
RTNG 420	39805	40	N	20,00	3,40	2,0	4,00
RTNG 525	40366	50	N	25,00	4,10	2,5	5,00
RTNG 630	39031	60	N	30,00	4,90	3,0	6,00
RTNG 840	44679	80	N	30,00	6,50	4,0	8,00
RTNG 1050	54990	100	N	30,00	8,10	5,0	10,00



Fitting tools

Inserts for grooving and parting off | Hard material machining

BTNN
System P92

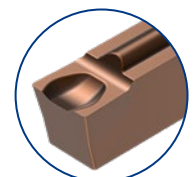
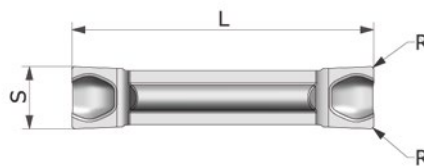

Enlarged view

WG302 Ref.	KM Hardlox 2 ID-Nr.	pocket size	(C)	L ±0,10	R	S ±0,10
BTNN1,5	38760	15	N	15,50	0,2	1,575
BTNN 2	38761	20	N	20,00	0,2	2,075
BTNN 2,5	38762	20	N	20,00	0,2	2,575
BTNN 3	38763	30	N	20,00	0,2	3,075
BTNN 4	38764	40	N	20,00	0,2	4,075



Fitting tools

Inserts for grooving and parting off | Hard material machining

CTD ALU
System P92

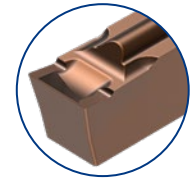
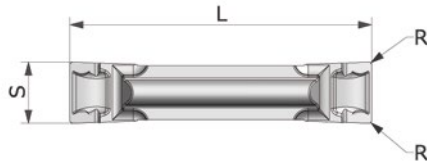
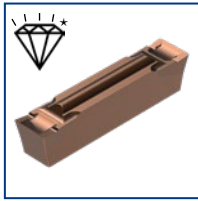

Enlarged view

WG302 Ref.	GF110 Hardlox 2 ID-Nr.	pocket size	⌀	L	R	S ±0,10
CTD 1.5 ALU	54900	1.5	N	15,5 ±0,15	0,15	1,575
CTD 2 ALU	54902	2.0	N	20 ±0,15	0,2	2,075
CTD 2.5 ALU	54904	2.0	N	20 ±0,15	0,2	2,575
CTD 3 ALU	38758	3.0	N	20 ±0,15	0,2	3,075
CTD 4 ALU	38759	4.0	N	20 ±0,15	0,2	4,075
CTD 5 ALU	54896	5.0	N	25 ±0,20	0,2	5,125

ALU chip breaker: Horizontal ground cutting edge. The flat chip chamber conveys chips at high speed. Recommended for: Nonferrous heavy metals, machining steels, thinwalled parts, unstable components and pipes.

Fitting tools, see below

SCTD
System P92

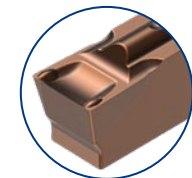
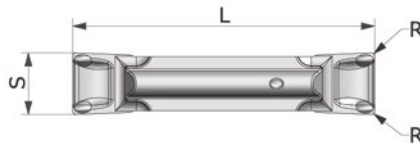

Enlarged view

WG302 Ref.	GF110 Hardlox 2 ID-Nr.	pocket size	⌀	L	R	S ±0,10
SCTD 1,5	54911	15	N	15,50 ±0,15	0,2	1,575
SCTD 2	54991	20	N	20,00 ±0,15	0,2	2,075
SCTD 2,5	54992	20	N	20,00 ±0,15	0,2	2,575
SCTD 3,0	54993	30	N	20,00 ±0,15	0,2	3,075
SCTD 4,0	54994	40	N	20,00 ±0,15	0,2	4,075
SCTD 5,0	54995	50	N	25,00 ±0,20	0,2	5,125

SUPERNOVA Parting off geometry...

Slightly honed cutting edge with reinforced flanks and large chip trough.

Fitting tools



p. 94-106, 194

p. 229

p. 230

p. 232

p. 88-89

p. 90-92

p. 94-98

p. 101-104

p. 105

p. 106

p. 113-116

p. 118-119

p. 121

p. 194

p. 220

Inserts for grooving with one edge | Hard material machining

KCTD
System P92

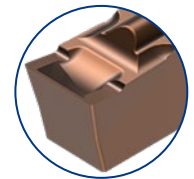
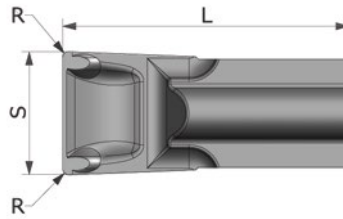
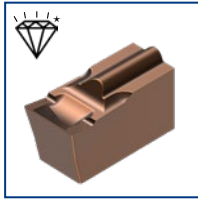

Enlarged view

WG302 Ref.	KM Hardlox 2 ID-Nr.	pocket size		P	L	R	S ^{+0,15}	boring bar-Ø
KCTD 3	38768	K30	N	3	9,5	0,2	3,0	12
KCTD 3	38768	K30	N	4,5	9,5	0,2	3,0	16
KCTD 3 MAX	38769	K30	N	5,5	12	0,2	3,0	12
KCTD 3 MAX	38769	K30	N	7	12	0,2	3,0	16

Remark

Inserts for small diameters.

Fitting tools

p. 108	p. 229	p. 230	p. 232	p. 108

HOLDERS for parting off, grooving and turning for cutting width 1,5 mm

P92 CXCBL
System P92

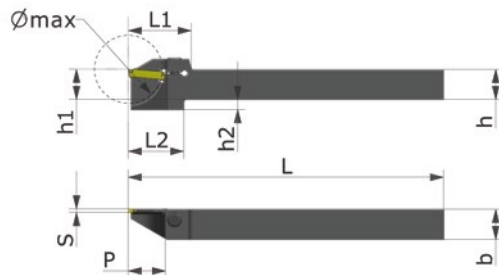
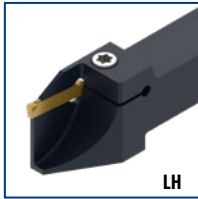

P92 CXCBR
System P92



WG380 Ref.	ID-Nr.	pocket size	(C)	Ø max	h	h1	h2	b	P	S	L	L1	L2	
P92 CXCBL 0808 K15 08	33450	15	L	16	8	8	4	8	8	1,5	125	19	19	10
P92 CXCBL 1010 K15 08	30110	15	L	16	10	10	6	10	8	1,5	125	19	19	10
P92 CXCBL 1010 K15 14	44738	15	L	28	10	10	6	10	14	1,5	125	25	22	10
P92 CXCBL 1212 K15 08	30109	15	L	16	12	12	4	12	8	1,5	125	19	19	10
P92 CXCBL 1212 K15 14	44739	15	L	28	12	12	4	12	14	1,5	125	25	22	10
P92 CXCBL 1616 K15 08	30100	15	L	16	16	16	-	16	8	1,5	125	19	-	10
P92 CXCBL 1616 K15 14	44740	15	L	28	16	16	-	16	14	1,5	125	25	-	10
P92 CXCBL 2020 K15 14	44741	15	L	28	20	20	-	25	14	1,5	125	25	-	10
P92 CXCBL 2525 M15 14	33460	15	L	28	25	25	-	25	14	1,5	150	30	-	1
P92 CXCBR 0808 K15 08	33449	15	R	16	8	8	4	8	8	1,5	125	19	19	10
P92 CXCBR 1010 K15 08	30124	15	R	16	10	10	6	10	8	1,5	125	19	19	10
P92 CXCBR 1010 K15 14	44733	15	R	28	10	10	6	10	14	1,5	125	25	22	10
P92 CXCBR 1212 K15 08	30125	15	R	16	12	12	4	12	8	1,5	125	19	19	10
P92 CXCBR 1212 K15 14	44734	15	R	28	12	12	4	12	14	1,5	125	25	22	10
P92 CXCBR 1616 K15 08	30126	15	R	16	16	16	-	16	8	1,5	125	19	-	10
P92 CXCBR 1616 K15 14	44735	15	R	28	16	16	-	16	14	1,5	125	25	-	10
P92 CXCBR 2020 K15 14	44736	15	R	28	20	20	-	25	14	1,5	125	25	-	10
P92 CXCBR 2525 M15 14	33459	15	R	28	25	25	-	25	14	1,5	150	30	-	1

Fitting tools, see below

HOLDERS for parting off, grooving and turning for Traub TR12 for cutting width 1,5 mm

P92 CXCBR...TR12
System P92

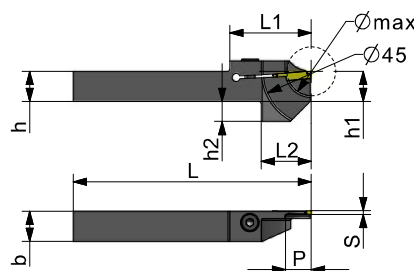
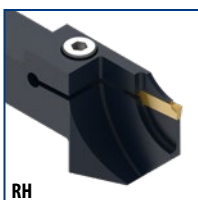

WG380 Ref.	ID-Nr.	pocket size	(C)	Ø max	h	h1	h2	b	P	S	L	L1	L2	
P92 CXCBR 1212 K15 10 TR12	54546	15	R	20	12	12	8	12	10	1,5	95	32,5	20	18

Fitting tools

- Torque
p. 226, 227, 252
- Tech. Section
p. 229
- pocket size
p. 230
- p. 74-80
- Hard material machining
p. 83-86

Holders for parting off, grooving and turning for cutting width 2 and 2,5 mm

P92 CXCBL
System P92

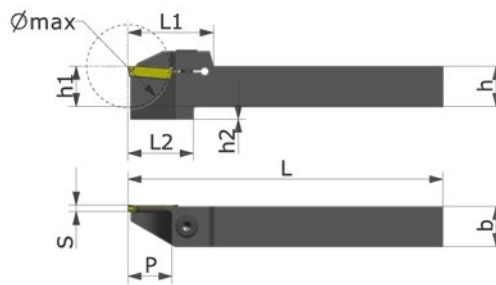
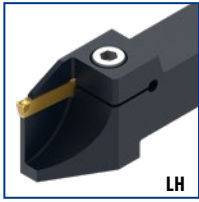

P92 CXCBR
System P92

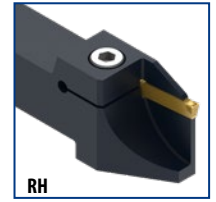

WG380 Ref.	ID-Nr.	pocket size	↻	Ø max	h	h1	h2	b	P	S	L	L1	L2	
P92 CXCBL 0808 K20+25 11	33444	20	L	22	8	8	4	8	11	2+2,5	125	19,5	19,5	10
P92 CXCBL 1010 K20+25 11	33445	20	L	22	10	10	6	10	11	2+2,5	125	19,5	19,5	10
P92 CXCBL 1212 K20+25 11	33448	20	L	22	12	12	4	12	11	2+2,5	125	19,5	19,5	10
P92-CXCBL 1212 K20+25 14	44742	20	L	28	12	12	4	12	14	2+2,5	125	25	22	10
P92 CXCBL 1616 K20+25 11	33452	20	L	22	16	16	-	16	11	2+2,5	125	19,5	-	10
P92 CXCBL 1616 K20+25 17	33473	20	L	34	16	16	5	16	17	2+2,5	125	34	26	1
P92 CXCBL 2020 K20+25 14	33454	20	L	28	20	20	-	20	14	2+2,5	125	30	-	1
P92 CXCBL 2020 K20+25 17	33474	20	L	34	20	20	-	20	17	2+2,5	125	34	-	1
P92 CXCBL 2525 M20+25 14	33455	20	L	28	25	25	-	25	14	2+2,5	150	30	-	1
P92 CXCBL 2525 M20+25 17	33475	20	L	34	25	25	-	25	17	2+2,5	150	34	-	1
P92 CXCBR 0808 K20+25 11	33336	20	R	22	8	8	4	8	11	2+2,5	125	19,5	19,5	10
P92 CXCBR 1010 K20+25 11	33446	20	R	22	10	10	6	10	11	2+2,5	125	19,5	19,5	10
P92 CXCBR 1212 K20+25 11	33447	20	R	22	12	12	4	12	11	2+2,5	125	19,5	19,5	10
P92-CXCBR 1212 K20+25 14	44737	20	R	28	12	12	4	12	14	2+2,5	125	25	22	10
P92 CXCBR 1616 K20+25 11	33451	20	R	22	16	16	-	16	11	2+2,5	125	19,5	-	10
P92 CXCBR 1616 K20+25 17	33470	20	R	34	16	16	5	16	17	2+2,5	125	34	26	1
P92 CXCBR 2020 K20+25 14	33453	20	R	28	20	20	-	20	14	2+2,5	125	30	-	1
P92 CXCBR 2020 K20+25 17	33471	20	R	34	20	20	-	20	17	2+2,5	125	34	-	1
P92 CXCBR 2525 M20+25 14	33456	20	R	28	25	25	-	25	14	2+2,5	150	30	-	1
P92 CXCBR 2525 M20+25 17	33472	20	R	34	25	25	-	25	17	2+2,5	150	34	-	1

Tailor made high pressure cooling system available.
More information at page 215

Fitting tools

- Torque p. 226, 227, 252
- Tech. Section p. 229
- pocket size p. 230
- p. 61 - 69
- p. 71
- p. 74-80
- Hard material machining p. 83-86

HOLDERS for parting off, grooving and turning for cutting width 2 and 2,5 mm

P92 CXCBL...
System P92

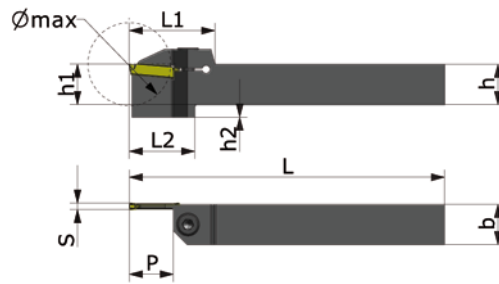
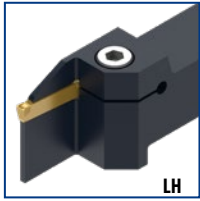

P92 CXCBR...
System P92

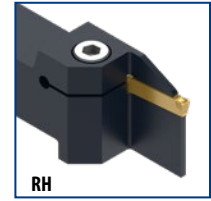

WG380 Ref.	ID-Nr.	pocket size	⌀	Ø max	h	h1	h2	b	P	S	L	L1	L2	
P92 CXCBL 1616 K20+25	59178	20	L	34	16	16	5	16	17	2+2,5	125	34	26	1
P92 CXCBL 2020 K20+25	59179	20	L	34	20	20	-	20	17	2+2,5	125	34	-	1
P92 CXCBL 2525 M20+25	59180	20	L	34	25	25	-	25	17	2+2,5	150	34	-	1
P92 CXCBR 1616 K20+25	59181	20	R	34	16	16	5	16	17	2+2,5	125	34	26	1
P92 CXCBR 2020 K20+25	59182	20	R	34	20	20	-	20	17	2+2,5	125	34	-	1
P92 CXCBR 2525 M20+25	59183	20	R	34	25	25	-	25	17	2+2,5	150	34	-	1

Comment

Tool holders with an extension of 17 mm offer an enlarged range for parting off. When used for turning, moderate feeds should be applied.

Fitting inserts

- Torque: p. 226, 227, 252
- Tech. Section: p. 229
- pocket size: p. 230
- Technical drawing: p. 61 - 69
- Application: p. 71
- Application: p. 74-80
- Hard material machining: p. 83-86

Select the smallest possible extension

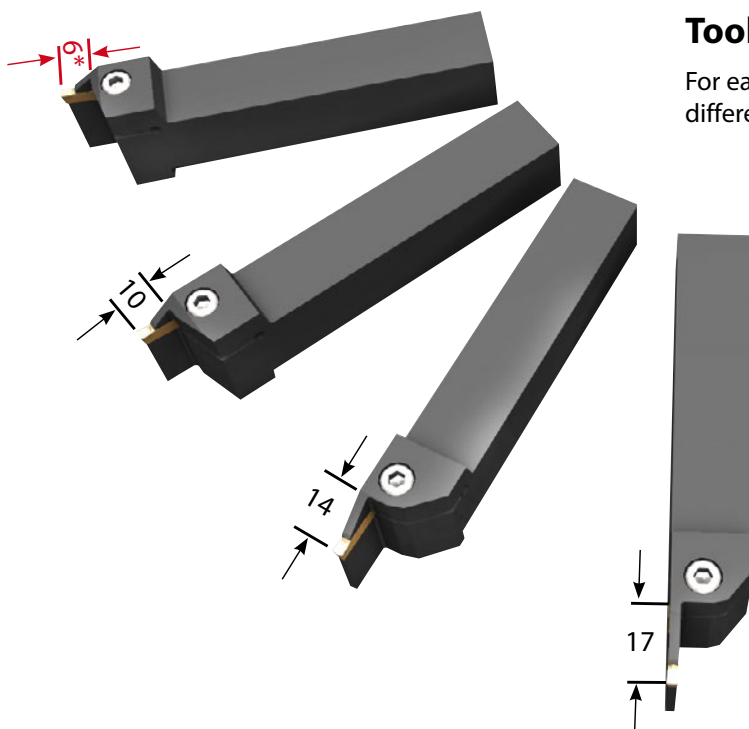

Tool holder standards:

For each cutting width are different extensions available.

*Special solution

Tailor made high pressure cooling system available.
More information at page 215

Holders for parting off, grooving and turning for cutting width range 3 to 3,5 mm

P92 CXCBL
System P92

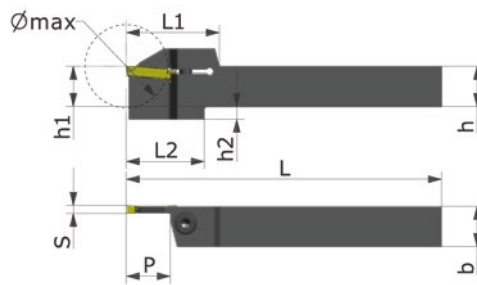
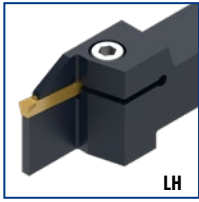

P92 CXCBR
System P92

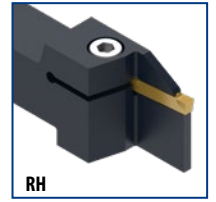

WG380 Ref.	ID-Nr.	pocket size	()	Ø max	h	h1	h2	b	P	S	L	L1	L2	
P92 CXCBL 1212 K30 10	28189	30	L	20	12	12	5	12	10	3,0	125	21	22	11
P92 CXCBL 1212 K30 14	19698	30	L	28	12	12	5	12	14	3,0	125	34	26	1
P92 CXCBL 1616 K30 10	38514	30	L	20	16	16	5	16	10	3,0	125	28	22	1
P92 CXCBL 1616 K30 14	10092	30	L	28	16	16	5	16	14	3,0	125	34	28	1
P92 CXCBL 1616 K30 17	10094	30	L	34	16	16	5	16	17	3,0	125	37	31	1
P92 CXCBL 2020 K30 10	38515	30	L	20	20	20	5	20	10	3,0	125	30	26	1
P92 CXCBL 2020 K30 14	10096	30	L	28	20	20	5	20	14	3,0	125	34	26	1
P92 CXCBL 2020 K30 17	10098	30	L	34	20	20	5	20	17	3,0	125	37	29	1
P92 CXCBL 2525 M30 10	31254	30	L	20	25	25	-	25	10	3,0	150	30	-	2
P92 CXCBL 2525 M30 14	10108	30	L	28	25	25	-	25	14	3,0	150	34	-	2
P92 CXCBL 2525 M30 17	10110	30	L	34	25	25	-	25	17	3,0	150	37	-	2
P92 CXCBR 1212 K30 10	28188	30	R	20	12	12	5	12	10	3,0	125	21	22	11
P92 CXCBR 1212 K30 14	19533	30	R	28	12	12	5	12	14	3,0	125	34	26	1
P92 CXCBR 1616 K30 10	38516	30	R	20	16	16	5	16	10	3,0	125	28	22	1
P92 CXCBR 1616 K30 14	10091	30	R	28	16	16	5	16	14	3,0	125	34	28	1
P92 CXCBR 1616 K30 17	10093	30	R	34	16	16	5	16	17	3,0	125	37	31	1
P92 CXCBR 2020 K30 10	38517	30	R	20	20	20	5	20	10	3,0	125	30	26	1
P92 CXCBR 2020 K30 14	10095	30	R	28	20	20	5	20	14	3,0	125	34	26	1
P92 CXCBR 2020 K30 17	10097	30	R	34	20	20	5	20	17	3,0	125	37	29	1
P92 CXCBR 2525 M30 10	36432	30	R	20	25	25	-	25	10	3,0	150	30	-	2
P92 CXCBR 2525 M30 14	10107	30	R	28	25	25	-	25	14	3,0	150	34	-	2
P92 CXCBR 2525 M30 17	10109	30	R	34	25	25	-	25	17	3,0	150	37	-	2
P92 CXCBL 2020 K35 17	10100	40	L	34	20	20	5	20	17	3,5	125	37	29	1
P92 CXCBL 2525 M35 17	10112	40	L	34	25	25	-	25	17	3,5	150	37	-	2
P92 CXCBR 2020 K35 17	10099	40	R	34	20	20	5	20	17	3,5	125	37	29	1
P92 CXCBR 2525 M35 17	10111	40	R	34	25	25	-	25	17	3,5	150	37	-	2

Comment: Tool holders with an extension of 17 mm offer an enlarged range for parting off. When used for turning, moderate feeds should be applied.

Tailor made high pressure cooling system available.
More information at page 215

Fitting tools

- Torque: p. 226, 227, 252
- Tech. Section: p. 229
- pocket size: p. 230
- p. 61 - 70
- p. 71
- p. 74-80
- Hard material machining: p. 83-86

HOLDERS for parting off, grooving and turning for cutting width range 4 to 5 mm

P92 CXCBL
System P92

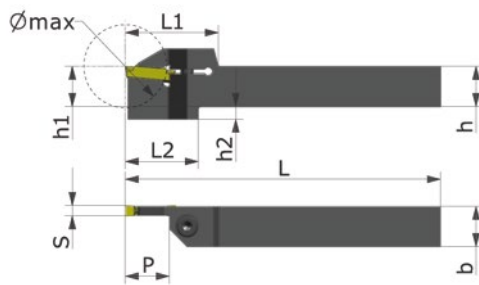
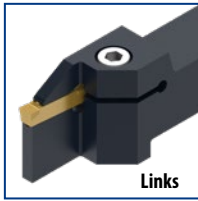

P92 CXCBR
System P92

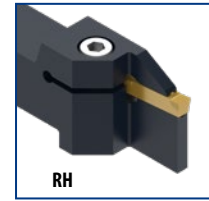

4

WG380 Ref.	ID-Nr.	pocket size	↻	Ø max	h	h1	h2	b	P	S	L	L1	L2	
P92 CXCBL 1616 K40 10	38523	40	L	20	16	16	5	16	10	4	125	28	22	1
P92 CXCBL 1616 K40 14	19476	40	L	28	16	16	5	16	14	4	125	34	26	1
P92 CXCBL 1616 K40 17	28191	40	L	34	16	16	5	16	17	4	125	37	29	1
P92 CXCBL 2020 K40 10	38524	40	L	20	20	20	5	20	10	4	125	30	26	1
P92 CXCBL 2020 K40 14	10102	40	L	28	20	20	5	20	14	4	125	34	26	1
P92 CXCBL 2020 K40 17	10104	40	L	34	20	20	5	20	17	4	125	37	29	1
P92 CXCBL 2525 M40 10	38525	40	L	20	25	25	-	25	10	4	150	30	-	2
P92 CXCBL 2525 M40 14	10114	40	L	28	25	25	-	25	14	4	150	34	-	2
P92 CXCBL 2525 M40 17	10116	40	L	34	25	25	-	25	17	4	150	37	-	2
<hr/>														
P92 CXCBR 1616 K40 10	20619	40	R	20	16	16	5	16	10	4	125	28	22	1
P92 CXCBR 1616 K40 14	19477	40	R	28	16	16	5	16	14	4	125	34	26	1
P92 CXCBR 1616 K40 17	23199	40	R	34	16	16	5	16	17	4	125	37	29	1
P92 CXCBR 2020 K40 10	38527	40	R	20	20	20	5	20	10	4	125	30	26	1
P92 CXCBR 2020 K40 14	10101	40	R	28	20	20	5	20	14	4	125	34	26	1
P92 CXCBR 2020 K40 17	10103	40	R	34	20	20	5	20	17	4	125	37	29	1
P92 CXCBR 2525 M40 10	38528	40	R	20	25	25	-	25	10	4	150	30	-	2
P92 CXCBR 2525 M40 14	10113	40	R	28	25	25	-	25	14	4	150	34	-	2
P92 CXCBR 2525 M40 17	10115	40	R	34	25	25	-	25	17	4	150	37	-	2
<hr/>														
P92 CXCBL 2020 K50 10	19568	50	L	20	20	20	5	20	10	5	125	34,5	30	1
P92 CXCBL 2020 K50 20	44224	50	L	40	20	20	5	20	20	5	125	40	33	2
P92 CXCBL 2525 M50 10	38526	50	L	20	25	25	-	25	10	5	150	34,5	-	2
P92 CXCBL 2525 M50 20	10118	50	L	40	25	25	-	25	20	5	150	40	-	2
<hr/>														
P92 CXCBR 2020 K50 10	16033	50	R	20	20	20	5	20	10	5	125	34,5	30	1
P92 CXCBR 2020 K50 20	44223	50	R	40	20	20	5	20	20	5	125	40	33	2
P92 CXCBR 2525 M50 10	38529	50	R	20	25	25	-	25	10	5	150	34,5	-	2
P92 CXCBR 2525 M50 20	10117	50	R	40	25	25	-	25	20	5	150	40	-	2

Comment

Tool holders with an extension of 17 mm offer an enlarged range for parting off. When used for turning, moderate feeds should be applied.

Fitting inserts

p. 226, 227, 252	p. 229	p. 230	p. 61 - 70	p. 71
			p. 74-78	p. 83-86

Holders for parting off, grooving and turning for cutting width range 6 to 10 mm

P92 CXCBL
System P92

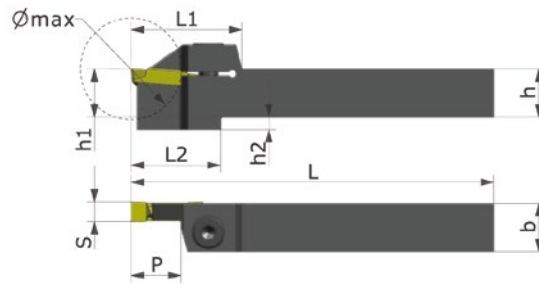
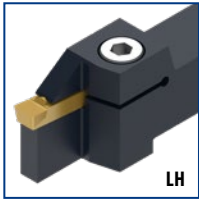

P92 CXCBR
System P92

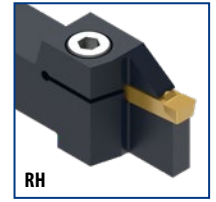

WG380 Ref.	ID-Nr.	pocket size	(C)	Ø max	h	h1	h2	b	P	S	L	L1	L2	
P92 CXCBL 2020 M60 10	21252	60	L	20	20	20	5	20	10	6	150	38	29	2
P92 CXCBL 2020 M60 20	19757	60	L	40	20	20	5	20	20	6	150	43	35	2
P92 CXCBL 2525 M60 10	38520	60	L	20	25	25	-	25	10	6	150	38	-	2
P92 CXCBL 2525 M60 20	19347	60	L	40	25	25	-	25	20	6	150	40	-	2
P92 CXCBL 3225 P60 26	19349	60	L	52	32	32	-	25	26	6	170	45	-	2
P92 CXCBR 2020 M60 10	21253	60	R	20	20	20	5	20	10	6	150	38	29	2
P92 CXCBR 2020 M60 20	19758	60	R	40	20	20	5	20	20	6	150	43	35	2
P92 CXCBR 2525 M60 10	20803	60	R	20	25	25	-	25	10	6	150	38	-	2
P92 CXCBR 2525 M60 20	19327	60	R	40	25	25	-	25	20	6	150	40	-	2
P92 CXCBR 3225 P60 26	19348	60	R	52	32	32	-	25	26	6	170	45	-	2
P92 CXCBL 2020 M80 14	30298	80	L	28	20	20	5	20	14	8	150	39,5	31	2
P92 CXCBL 2525 M80 20	19354	80	L	40	25	25	-	25	20	8	150	43	-	3
P92 CXCBL 3225 P80 26	19350	80	L	52	32	32	-	25	26	8	170	47	-	3
P92 CXCBR 2020 M80 14	30297	80	R	28	20	20	5	20	14	8	150	39,5	31	2
P92 CXCBR 2525 M80 20	19355	80	R	40	25	25	-	25	20	8	150	43	-	3
P92 CXCBR 3225 P80 26	19351	80	R	52	32	32	-	25	26	8	170	47	-	3
P92 CXCBL 3225 P100 26	19352	100	L	52	32	32	-	25	26	10	170	47	-	3
P92 CXCBR 3225 P100 26	19353	100	R	52	32	32	-	25	26	10	170	47	-	3

Fitting inserts

- Torque: p. 226, 227, 252
- Tech. Section: p. 229
- pocket size: p. 230
- p. 61 - 70
- p. 71
- Hard material machining: p. 83-86

4 Holders for parting off with internal cooling | with 3 thread connections

P92 CXCBL
20+25 HP

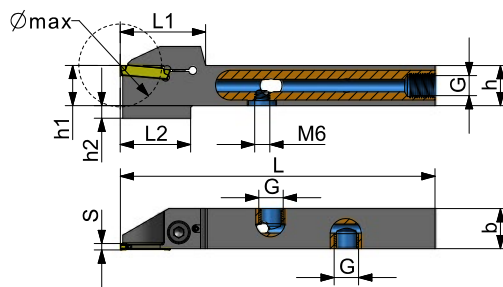
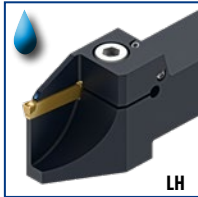

P92 CXCBR
20+25 HP



WG3805 Ref.	ID-Nr.	pocket size	()	G	Ø max	h	h1	h2	b	S	L	L1	L2	
P92 CXCBL 1212 K20+25 11HPM8x1	57245	20	L	M8x1	22	12	12	4	12	2+2,5	125	19,5	19,5	10
P92 CXCBL 1616 K20+25 11HPG1/8	57247	20	L	G1/8	22	16	16	-	16	2+2,5	125	19,5	-	10
P92 CXCBL 1616 K20+25 17HPG1/8	57248	20	L	G1/8	34	16	16	5	16	2+2,5	125	34	26	1
P92 CXCBL 2020 K20+25 17HPG1/8	57251	20	L	G1/8	34	20	20	-	20	2+2,5	125	34	-	1
P92 CXCBR 1212 K20+25 11HPM8x1	57255	20	R	M8x1	22	12	12	4	12	2+2,5	125	19,5	19,5	10
P92 CXCBR 1616 K20+25 11HPG1/8	57257	20	R	G1/8	22	16	16	-	16	2+2,5	125	19,5	-	10
P92 CXCBR 1616 K20+25 17HPG1/8	57258	20	R	G1/8	34	16	16	5	16	2+2,5	125	34	26	1
P92 CXCBR 2020 K20+25 17HPG1/8	57262	20	R	G1/8	34	20	20	-	20	2+2,5	125	34	-	1

Delivery with 1 key and 3 plugs

Fitting inserts, see below

P92 CXCBL 30 HP

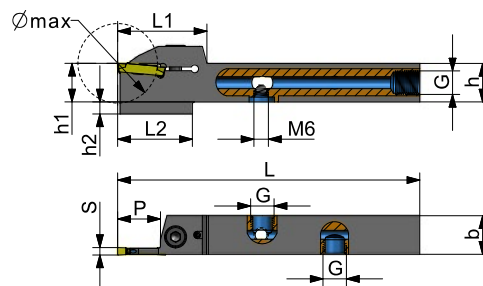

P92 CXCBR 30 HP



WG3805 Ref.	ID-Nr.	pocket size	()	G	Ø max	h	h1	h2	b	P	S	L	L1	L2	
P92 CXCBL 1212 K30 14HPM8x1	57246	30	L	M8x1	28	12	12	5	12	14	3,0	125	30	26	11
P92 CXCBL 1616 K30 14HPG1/8	57249	30	L	G1/8	28	16	16	5	16	14	3,0	125	34	26	1
P92 CXCBL 1616 K30 17HPG1/8	57250	30	L	G1/8	34	16	16	5	16	17	3,0	125	37	29	1
P92 CXCBL 2020 K30 17HPG1/8	57252	30	L	G1/8	34	20	20	5	20	17	3,0	125	37	29	1
P92 CXCBL 2525 M30 17HPG1/8	57253	30	L	G1/8	34	25	25	-	25	17	3,0	150	37	-	2
P92 CXCBR 1212 K30 14HPM8x1	57256	30	R	M8x1	28	12	12	5	12	14	3,0	125	34	26	11
P92 CXCBR 1616 K30 14HPG1/8	57259	30	R	G1/8	28	16	16	5	16	14	3,0	125	34	26	1
P92 CXCBR 1616 K30 17HPG1/8	57261	30	R	G1/8	34	16	16	5	16	17	3,0	125	37	29	1
P92 CXCBR 2020 K30 17HPG1/8	57263	30	R	G1/8	34	20	20	5	20	17	3,0	125	37	29	1
P92 CXCBR 2525 M30 17HPG1/8	57264	30	R	G1/8	34	25	25	-	25	17	3,0	150	37	-	2

Tailor made high pressure cooling system available. More information at page 215

Fitting inserts

- Torque: p. 226, 227, 252
- Tech. Section: p. 229
- pocket size: p. 230
- p. 61 - 70
- p. 71
- p. 74-80
- Hard material machining: p. 83-86

90° - Holders for many different turning applications

P92 90 UNI

System P92

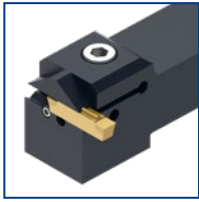

RH and LH pocket

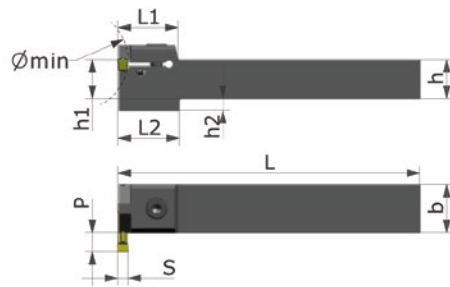

WG380 Ref.	ID-Nr.	pocket size	↻	Dmin	h	h1	h2	b	P	S	L	L1	L2	
P92 90 CXCBRL 1616 K30 UNI	38485	30	R + L	>70	16	16	4	16	5	3	125	25	26	1+13
P92 90 CXCBRL 2020 K30 UNI	38486	30	R + L	>70	20	20	-	20	5	3	125	25	-	1+13
P92 90 CXCBRL 2525 M30 UNI	38487	30	R + L	>70	25	25	-	25	5	3	150	25	-	1+13
P92 90 CXCBRL 2020 K60 UNI	24260	60	R + L	>120	20	20	-	20	11,0	6	125	34	-	14+20
P92 90 CXCBRL 2525 M60 UNI	24261	60	R + L	>120	25	25	-	25	11,0	6	150	34	-	14+20
P92 90 CXCBRL 3232 P60 UNI	24262	60	R + L	>120	32	32	-	32	11,0	6	170	34	-	14+20
P92 90 CXCBRL 2020 K80 UNI	24263	80	R + L	>120	20	20	5	20	11,0	8	125	40	31	3+21
P92 90 CXCBRL 2525 M80 UNI	24264	80	R + L	>120	25	25	-	25	11,0	8	150	40	-	3+21
P92 90 CXCBRL 3232 P80 UNI	24265	80	R + L	>120	32	32	-	32	11,0	8	170	40	-	3+21

UNI-Holder for clockwise (CW) and counter clockwise (CCW) run

<p>Insert positioned for clockwise (CW) run, face grooving </p> <p>Insert positioned for counter clockwise (CCW) run, grooving </p> <p>P92 inserts</p>	<p>Insert positioned for counter clockwise (CCW) run, face grooving </p> <p>Insert positioned for clockwise (CW) run, grooving </p> <p>P92 inserts</p>	<p>2 tapped holes for a positioning pin permit the use of P92 inserts for CW and CCW run!</p> <div style="display: flex; justify-content: space-around;"> </div>
--	--	--

<p>Face turning with RTNX 840 TILOX</p>		<p>Face turning with MTNS 812 TILOX</p>
--	--	--

- Fitting inserts**
- Torque
p. 226, 227, 252
 - Tech. Section
p. 229
 - pocket size
p. 230
 - p. 61 - 70
 - p. 71
 - p. 74-80
 - Hartbearbeitung
p. 83-86

Holder for deep cuts from \varnothing 42 mm up to \varnothing 56 mm and deep grooving

P92 A CXCBL
System P92

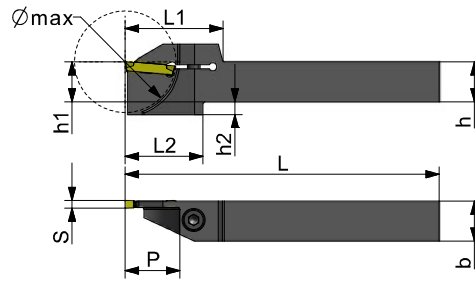
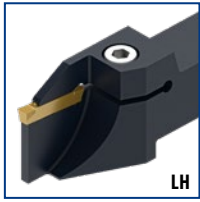

P92 A CXCBR
System P92

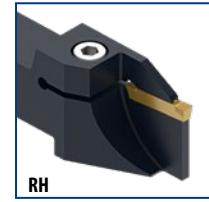

WG380 Ref.	ID-Nr.	pocket size	\curvearrowright	\varnothing max	h	h1	h2	b	P1	S	L	L1	L2	
P92 A CXCBL 1616 K30 42	35158	30	L	42	16	16	5	16	7,0	3,0	125	39	31	1
P92 A CXCBL 2020 K30 42	35160	30	L	42	20	20	5	20	7,0	3,0	125	39	31	1
P92 A CXCBL 2525 M30 42	35163	30	L	42	25	25	-	25	-	3,0	150	39	-	1
P92 A CXCBL 2020 K30 56	24890	30	L	56	20	20	5	20	20,5	3,0	125	46	38	1
P92 A CXCBL 2525 M30 56	24891	30	L	56	25	25	-	25	13,0	3,0	150	46	-	1
P92 A CXCBL 2020 K40 56	28182	40	L	56	20	20	5	20	20,5	4,0	125	46	38	1
P92 A CXCBL 2525 M40 56	28181	40	L	56	25	25	-	25	13,0	4,0	150	46	-	1
P92 A CXCBR 1616 K30 42	35159	30	R	42	16	16	5	16	7,0	3,0	125	39	31	1
P92 A CXCBR 2020 K30 42	35161	30	R	42	20	20	5	20	7,0	3,0	125	39	31	1
P92 A CXCBR 2525 M30 42	35162	30	R	42	25	25	-	25	-	3,0	150	39	-	1
P92 A CXCBR 2020 K30 56	25568	30	R	56	20	20	5	20	20,0	3,0	125	46	38	1
P92 A CXCBR 2525 M30 56	25685	30	R	56	25	25	-	25	13,0	3,0	150	46	-	1
P92 A CXCBR 2020 K40 56	28184	40	R	56	20	20	5	20	20,0	4,0	125	46	38	1
P92 A CXCBR 2525 M40 56	28180	40	R	56	25	25	-	25	13,0	4,0	150	46	-	1

Remark

P92 A-inserts and P92 A CXCB...holder join together to form an extremely solid unit owing to long guide surfaces between insert and pocket and reinforced tool holders. A-type tools are therefore recommended for heavy duty cutting, deep cuts and to achieve clean faces.

Recommendation: For deep grooving inserts with 2-edges are recommended.

Please note!

On parting off operations always select the **strongest tool holders**. This is a big advantage!

Make sure the holder's rear face **touches** the front face of the slide or basic tool holder firmly. If not, vibrations and fast edge wear will be the negative result of such improper set up.

Tailor made high pressure cooling system available.
More information at page 215

- 

Torque
p. 226, 227, 252
- 

Tech. Section
p. 229
- 

Plattensitzgröße
p. 230
- 

Fitting inserts
p. 61 - 70
- 

Fitting inserts
p. 71
- 

Fitting inserts
p. 74-80
- 

Hard material machining
p. 83-86

Holder for deep cuts from Ø 65 mm up to Ø 80 mm and deep grooving

P92 A CXCBL
System P92

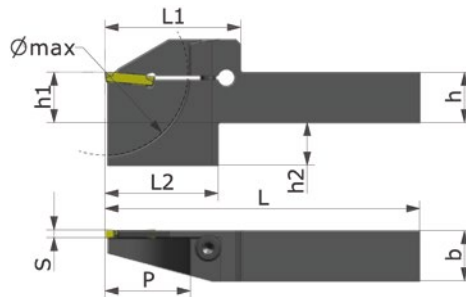
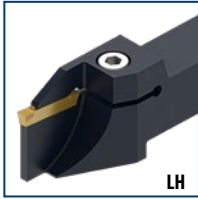

P92 A CXCBR
System P92

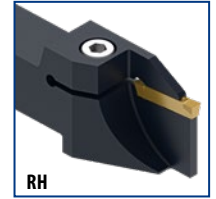

WG380 Ref.	ID-Nr.	pocket size	()	Ø max	h	h1	h2	b	S	L	L1	L2	
P92 A CXCBL 2020 K30 65	10136	30	L	65	20	20	17	20	3,0	125	54	45	12
P92 A CXCBL 2525 M30 65	10144	30	L	65	25	25	12	25	3,0	150	54	45	12
P92 A CXCBL 2020 K40 65	10140	40	L	65	20	20	17	20	4,0	125	54	45	12
P92 A CXCBL 2525 M40 65	10148	40	L	65	25	25	12	25	4,0	150	54	45	12
P92 A CXCBL 2020 M50 65	10142	50	L	80	20	20	17	20	5,0	150	62	52	12
P92 A CXCBL 2525 P50 80	10150	50	L	80	25	25	12	25	5,0	170	62	52	12
P92 A CXCBR 2020 K30 65	10135	30	R	65	20	20	17	20	3,0	125	54	45	12
P92 A CXCBR 2525 M30 65	10143	40	R	65	25	25	12	25	3,0	150	54	45	12
P92 A CXCBR 2020 K40 65	10139	40	R	65	20	20	17	20	4,0	125	54	45	12
P92 A CXCBR 2525 M40 65	10147	40	R	65	25	25	12	25	4,0	150	54	45	12
P92 A CXCBR 2020 M50 65	10141	50	R	80	20	20	17	20	5,0	150	62	52	12
P92 A CXCBR 2525 P50 80	10149	50	R	80	25	25	12	25	5,0	170	62	52	12

Remark

P92 A-inserts and P92 A CXCB...holder join together to form an extremely solid unit owing to long guide surfaces between insert and pocket and reinforced tool holders. A-type tools are therefore recommended for heavy duty cutting, deep cuts and to achieve clean faces.

Recommendation

For cutting deep chambers inserts with 2-edges are recommended.

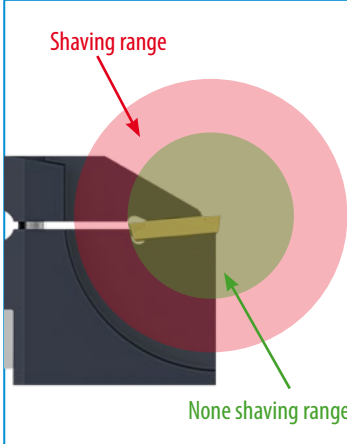



Shaving

If the cutting depth exceeds the length of the cutting insert, the second edge of the insert penetrates into the slot and may cause shaving marks on the component. To prevent from shaving the insert type A-BTNN is recommended.

How to write an order:			recommended
1 pc.	P92 A CXCBR 2020 K30	or:	1 pc. ID-Nr. 10135
10 pcs.	A BTNN 3 KM TILOX	or:	10 pcs. ID-Nr. 13953



Torque
p. 226, 227, 252



Tech. Section
p. 229

pocket size
p. 230

Fitting tools
p. 61 - 70



Hard material machining
p. 71

Fitting tools
p. 74-80

Hard material machining
p. 83-86

Holders and blades for parting off with internal cooling | with 3 thread connection

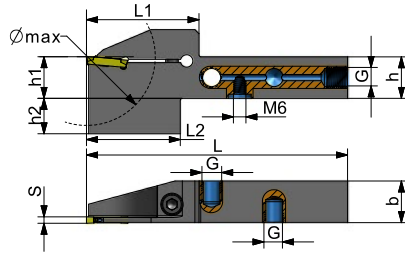
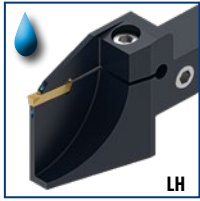
P92 A CXCBL HP



P92 A CXCBR HP



WG3805 Ref.	ID-Nr.	pocket size	()	G	Ø max	h	h1	h2	b	S	L	L1	L2	
P92 A CXCBL 2020 K30 65HPG1/8	57203	30	L	G1/8	65	20	20	17	20	3,0	125	54	45	12
P92 A CXCBL 2525 M30 65HPG1/8	57209	30	L	G1/8	65	25	25	12	25	3,0	150	54	45	12
P92 A CXCBL 2020 K40 65HPG1/8	57208	40	L	G1/8	65	20	20	17	20	4,0	125	54	45	12
P92 A CXCBL 2525 M40 65HPG1/8	57210	40	L	G1/8	65	25	25	12	25	4,0	150	54	45	12
P92 A CXCBR 2020 K30 65HPG1/8	57211	30	R	G1/8	65	20	20	17	20	3,0	125	54	45	12
P92 A CXCBR 2525 M30 65HPG1/8	57213	30	R	G1/8	65	25	25	12	25	3,0	150	54	45	12
P92 A CXCBR 2020 K40 65HPG1/8	57212	40	R	G1/8	65	20	20	17	20	4,0	125	54	45	12
P92 A CXCBR 2525 M40 65HPG1/8	57214	40	R	G1/8	65	25	25	12	25	4,0	150	54	45	12

Delivery with 1 key and 3 plugs

Tailor made high pressure cooling system available.
More information at page 215

Fitting inserts

- Torque p. 226, 227, 252
- Tech. Section p. 229
- pocket size p. 230
- p. 61 - 70
- p. 71
- p. 74-80
- Hard material machining p. 83-86

Designation code for dove-tail blades

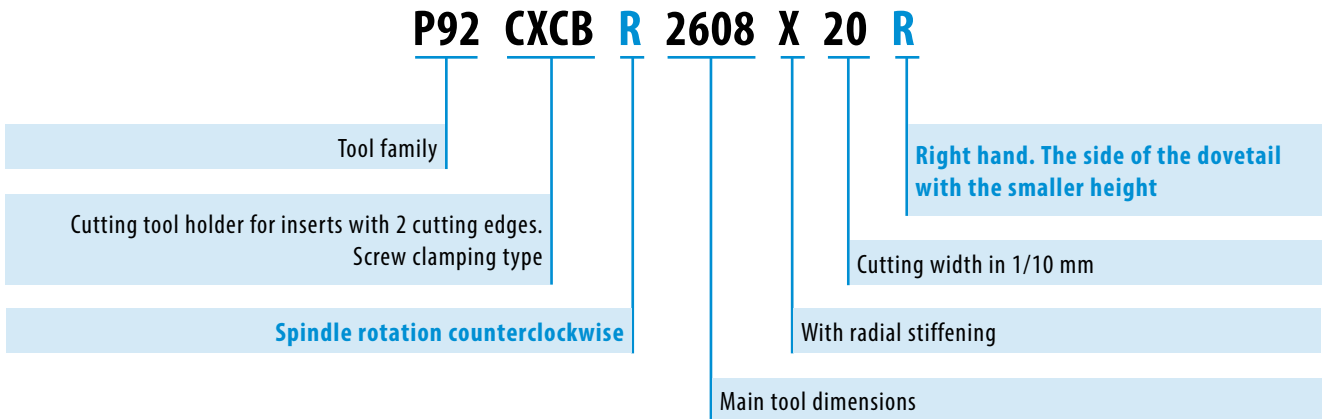

How to select the blade to fit your machine tool

To select a fitting blade for your machine tool, you have to determine:

- ▶ Spindle rotation CW: LH blade is required
CCW: RH blade is required
- ▶ The dovetail's small side when looked from the front side of the blade.

<p>P92 CXCB L 2608 X30 L</p> <p>Cutting edge left hand for clockwise rotation.</p> <p>Small side of the dovetail on the left side: LH.</p>	Type 1
<p>P92 CXCB L 2608 X30 R</p> <p>Cutting edge left hand for clockwise rotation.</p> <p>Small side of the dovetail on the right side: RH.</p>	Type 2
<p>P92 CXCB R 2608 X30 R</p> <p>Cutting edge right hand for clockwise rotation.</p> <p>Small side of the dovetail on the right side: RH.</p>	Type 3
<p>P92 CXCB R 2608 X30 L</p> <p>Cutting edge right hand for clockwise rotation.</p> <p>Small side of the dovetail on the left side: LH.</p>	Type 4

Remarks:

- ▶ These dovetail tool blades fit into many basic tool holders of automatic lathes like Traub, EMCO, Tornos, Bechler etc. **AND they also fit into the tool blocks on pages 182 and 183.**

Application field of dove-tail blades

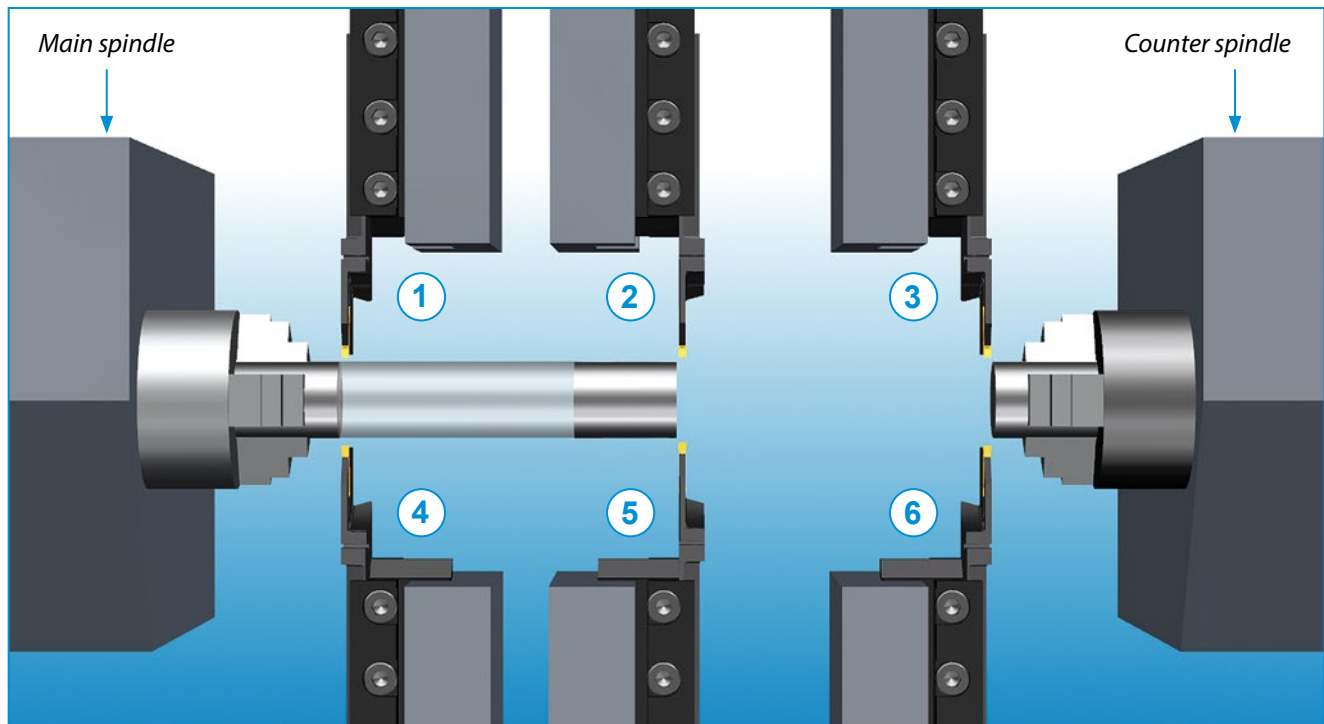

Nr.	Working position	Rotation		Type
1	Main spindle Behind center line	clockwise		LL (Type 1)
2	Main spindle Behind center line	clockwise		LR (Type 2)
3	Counter spindle Behind center line	counter clockwise (separate drive)		RR (Type 3)
4	Main spindle In front of center line	counter clockwise		RR (Type 3)
5	Main spindle In front of center line	counter clockwise		RL (Type 4)
6	Counter spindle In front of center line	clockwise (separate drive)		LL (Type 1)

A few application examples of dovetail blades on different machine tool positions.

Remark:

You'll find these blades on pages 101, 102, 153 and 165.

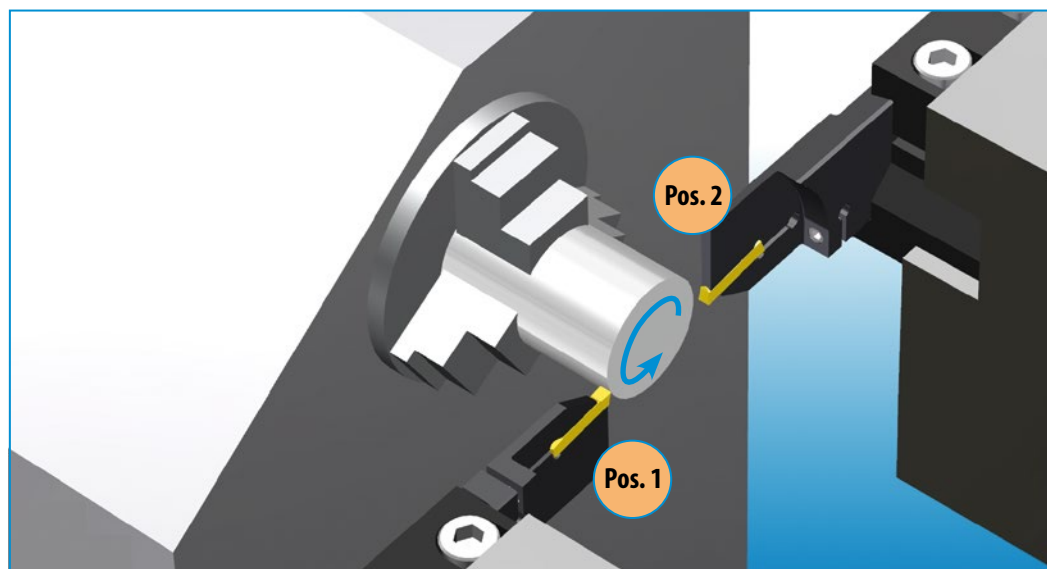

Example for application

Counter clockwise rotation regular and overhead, machining with a BTNN 3 GF110 NANOSPEED insert.

Pos. 1:

Blade R-R in front of bar

Pos. 2:

Blade R-R overhead behind the bar

Reinforced parting off blades with dovetail shank

P92..CXCBL 2608X..R/L

System P92

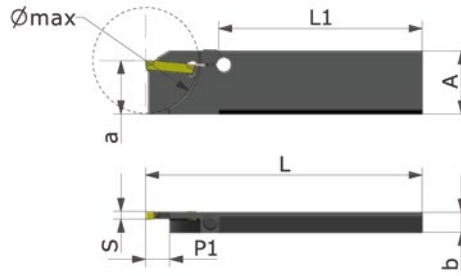

P92 CXCBR 2608X..R/L

System P92



WG380 Ref.	ID-Nr.	pocket size	(C)	A	a	Ø max	b	P1	S	L	L1	
P92 CXCBL 2608 X30R	19669	30	L	26	21,4	42	8	9,0	3,0	110	81,3	10
P92 CXCBL 2608 X30L	21614	30	L	26	21,4	42	8	9,0	3,0	110	81,3	10
P92 CXCBR 2608 X30R	21222	30	R	26	21,4	42	8	9,0	3,0	110	81,3	10
P92 CXCBR 2608 X30L	21613	30	R	26	21,4	42	8	9,0	3,0	110	81,3	10

Fitting inserts and tool blocks, see below

P92..CXCBL 3208X..R/L

System P92

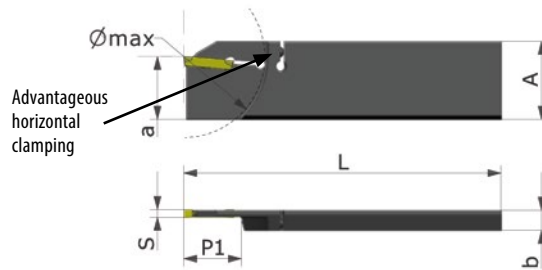

P92 CXCBR 3208X..R/L

System P92



WG380 Ref.	ID-Nr.	pocket size	(C)	A	a	Ø max	b	P1	S	L	
P92 CXCBL 3208 X30R 65	31784	30	L	32	25,0	65	8	22,0	3,0	126	42
P92 CXCBL 3208 X30L 65	31788	30	L	32	25,0	65	8	22,0	3,0	126	42
P92 CXCBR 3208 X30R 65	31780	30	R	32	25,0	65	8	22,0	3,0	126	42
P92 CXCBR 3208 X30L 65	29826	30	R	32	25,0	65	8	22,0	3,0	126	42

Comment

Blades and tool blocks with the same "A" dimension fit together.

Example for application you will find on page 100

Fitting inserts and tool blocks

Torque p. 226, 227, 252
 Tech. Section p. 229
 pocket size p. 230
 machining p. 61 - 70
 Hard material machining p. 71
 p. 74-82
 p. 83-86
 p. 182-183

Reinforced parting off blades with dovetail blade and internal cooling

P92 CXCBL 3208X...R/L65HP

System P92

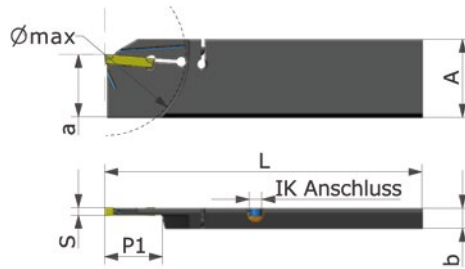

P92 CXCBR 3208X...R/L65HP

System P92



WG3805 Ref.	ID-Nr.	pocket size	(C)	A	a	Ø max	b	P1	S	L	
P92 CXCBL 3208 X30R 65 HP	58263	30	L	32	25,0	65	8	22,0	3,0	126	42
P92 CXCBL 3208 X30L 65 HP	57532	30	L	32	25,0	65	8	22,0	3,0	126	42
P92 CXCBR 3208 X30R 65 HP	58266	30	R	32	25,0	65	8	22,0	3,0	126	42
P92 CXCBR 3208 X30L 65 HP	58264	30	R	32	25,0	65	8	22,0	3,0	126	42

Application of reinforced parting off blades

moderate to heavy machining

Advantage:

- Large extension range
- Best possible tool life
- Clean faces
- No squeaking
- Superior performance

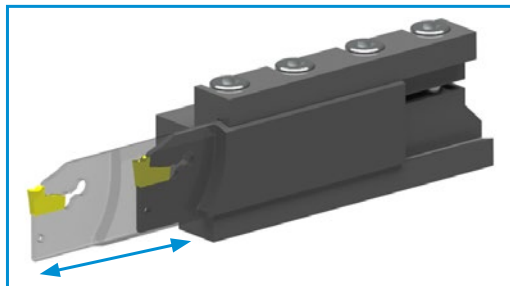

Good stability on large extensions.

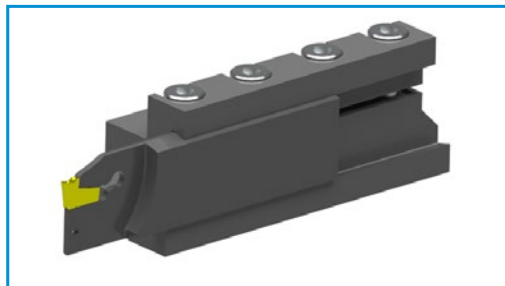

Large dovetail clamping faces.

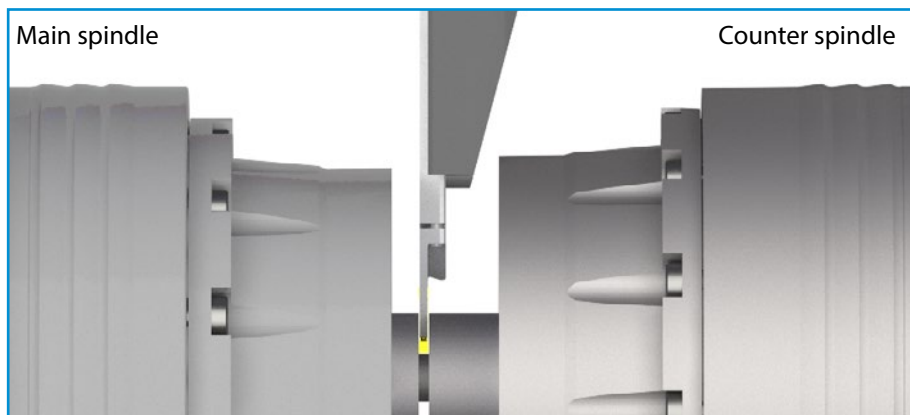

Machining in narrow spaces (for instance operations with counter spindle)

Fitting inserts and tools

Torque	Tech. Section	pocket size	machining	Hard material machining	
p. 226, 227, 252	p. 229	p. 230	p. 61 - 70	p. 71	p. 74-82
					p. 83-86
					p. 182-183

TWIN blade parting off blade

P92 TMS
System P92

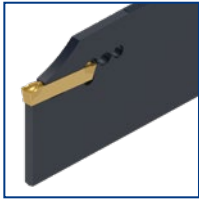

recommended range

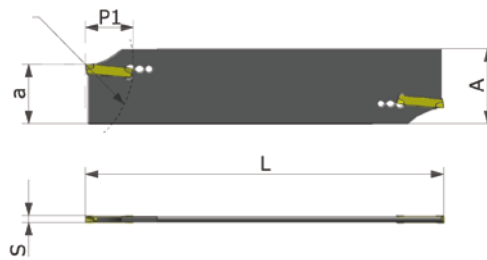

WG310 Ref.	ID-Nr.	pocket size	(C)	A	a	P1	S	L	
P92 TMS 26 20+25	36644	20	N	26	21,4	18,5	2+2,5	110	28
P92 TMS 32 20+25	36643	20	N	32	25,0	18,5	2+2,5	150	28
P92 TMS 26 30	36645	30	N	26	21,4	18,5	3,0	110	28
P92 TMS 32 30	33429	30	N	32	25,0	18,5	3,0	150	28
P92 TMS 32 35	34369	40	N	32	25,0	18,5	3,5	150	28
P92 TMS 32 40	36642	40	N	32	25,0	18,5	4,0	150	28
P92 TMS 32 50	44524	50	N	32	25,0	23,5	5,0	150	28
P92 TMS 32 60	44537	60	N	32	25,0	28,5	6,0	150	28

Remark

Blades and tool blocks with the same "A" dimension fit together.

If the cutting depth exceeds the length of the cutting insert, the second edge of the insert penetrates into the slot and may cause shaving marks on the components faces. To prevent from shaving the insert type A-BTNN is recommended.

Advantages

- ✓ Increased profitability compared to blades holding 1-edge inserts
- ✓ Reinforced solidity
- ✓ Perfect clamping and easy handling
- ✓ Marking for easy understanding
- ✓ Excellent tool life together with parting off inserts BTNN and A BTNN

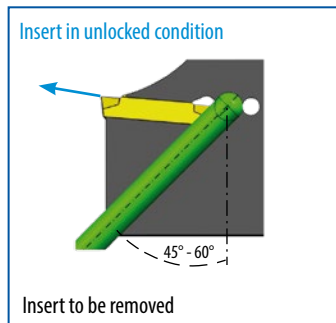
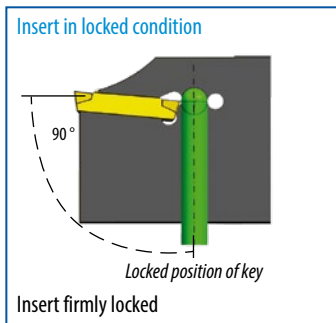

Fitting inserts

p. 226, 227, 252	p. 229	p. 230	p. 61 - 70	p. 71	p. 74-80
					p. 83-86
					p. 182-183

TWIN blade for parting off with internal cooling

P92 TMS HP

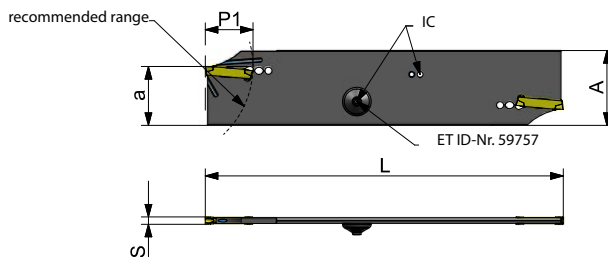

WG3105 Ref.	ID-Nr.	pocket size	(C)	A	a	P1	S	L	
P92 TMS 26 20+25 HP	57316	20	N	26	21,4	18,5	2+2,5	110	28
P92 TMS 32 20+25 HP	57318	20	N	32	25,0	18,5	2+2,5	150	28
P92 TMS 26 30 HP	57317	30	N	26	21,4	18,5	3,0	110	28
P92 TMS 32 30 HP	57319	30	N	32	25,0	18,5	3,0	150	28
P92 TMS 32 40 HP	57320	40	N	32	25,0	18,5	4,0	150	28

Tool block for holders with internal cooling

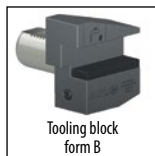
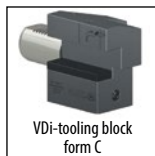

Extract from Megacut catalogue

Fitting tools

- Torque: p. 226, 227, 252
- Tech. Section: p. 229
- pocket size: p. 230
- p. 61 - 70
- p. 71
- p. 74-80
- Hard material machining: p. 83-86

TWIN parting off blade without internal cooling

P92 TMS 52

System P92

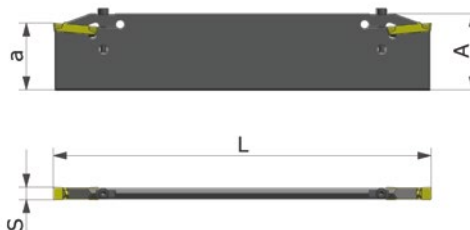

WG310 Ref.	ID-Nr.	pocket size	(C)	A	a	S	L	
P92 TMS 52 80	31464	80	N	52,6	45,0	8,0	250	11
P92 TMS 52 100	44539	100	N	52,6	45,0	10,0	250	11

Remark

Blades and tool blocks with the same "A" dimension fit together.

If the cutting depth exceeds the length of the cutting insert, the second edge of the insert penetrates into the slot and may cause shaving marks on the components faces.

Fitting inserts and tool blocks

- Tech. Section: p. 229
- pocket size: p. 230
- p. 61 - 70
- p. 71
- p. 183

Cartridge holders for parting off holders with internal cooling

P92 CL/R HP G1/8

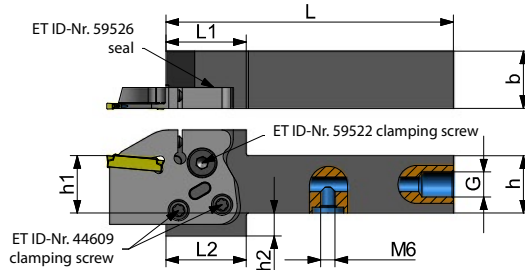

WG3865 Ref.	ID-Nr.	()	G	h	h1	h2	b	L	L1	L2	
P92 CL 2020 H HP G1/8	59539	L	G1/8	20	20	8	20	100	28	28	36+45
P92 CL 2525 H HP G1/8	59540	L	G1/8	25	25	6	25	100	28	28	36+45
P92 CR 2020 H HP G1/8	59541	R	G1/8	20	20	8	20	100	28	28	36+45
P92 CR 2525 H HP G1/8	59542	R	G1/8	25	25	6	25	100	28	28	36+45

Tool block for holders with internal cooling

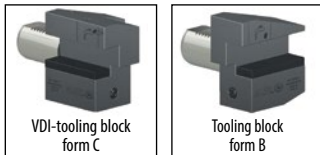

Extract from Megacut catalogue

Parting off cartridges for cartridge holders with internal cooling

P92 CT HP

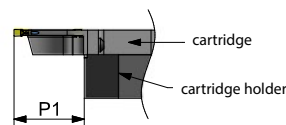
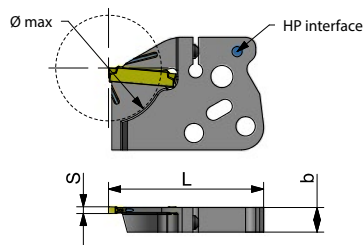

WG3865 Ref.	ID-Nr.	pocket size	()	Ømax	b	S size	L	P1	
P92 CT L 20+25 22 HP	58969	20+25	L	22	7,2	2,0+2,5	45,5	20,5	42
P92 CT L 20+25 32 HP	58970	20+25	L	32	7,2	2,0+2,5	45,5	20,5	42
P92 CT L 30 40 HP	58971	30	L	40	7,2	3,0	45,5	20,5	42
P92 CT R 20+25 22 HP	58972	20+25	R	22	7,2	2,0+2,5	45,5	20,5	42
P92 CT R 20+25 32 HP	58973	20+25	R	32	7,2	2,0+2,5	45,5	20,5	42
P92 CT R 30 40 HP	58974	30	R	40	7,2	3,0	45,5	20,5	42

Fitting inserts

- Torque: p. 226, 227, 252
- Tech. Section: p. 229
- pocket size: p. 230
- p. 61 - 70
- p. 71
- p. 74-80
- Hard material machining: p. 83-86

Boring bars with internal cooling for grooving and turning

P92 CGL
System P92

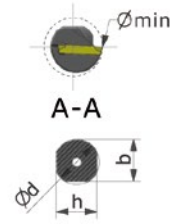
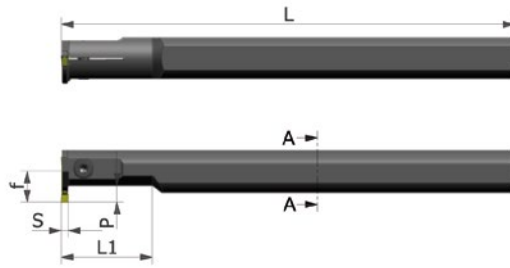

P92 CGR
System P92



4

WG390 Ref.	ID-Nr.	pocket size	()	Ømin	Ø d	h	b	f	P	S	L	L1	
P92 CGL 0016 P15	33461	15	L	20	16	15	15,5	11	7	1,5	170	26	7
P92 CGL 0020 R15	34954	15	L	25	20	18	18,5	13	7	1,5	200	40	6
P92 CGL 0020 R20+25	33463	20	L	25	20	18	18,5	13	7	2,0+2,5	200	40	6
P92 CGL 0020 R30	10066	30	L	25	20	18	18,5	13	7	3,0	200	40	6
P92 CGL 0020 R40	10070	40	L	25	20	18	18,5	13	7	4,0	200	40	6
P92 CGL 0025 R20+25	33465	20	L	32	25	23	23,0	17	10	2,0+2,5	200	50	14
P92 CGL 0025 R30	10072	30	L	32	25	23	23,0	17	10	3,0	200	50	14
P92 CGL 0025 R40	10076	40	L	32	25	23	23,0	17	10	4,0	200	50	14
P92 CGL 0032 S20+25	33467	20	L	40	32	30	30,0	22	12	2,0+2,5	250	64	1
P92 CGL 0032 S30	10078	30	L	40	32	30	30,0	22	12	3,0	250	64	14
P92 CGL 0032 S40	10082	40	L	40	32	30	30,0	22	12	4,0	250	64	14
P92 CGL 0032 S50	10084	50	L	44	32	30	30,0	26	16	5,0	250	64	14
P92 CGL 0040 S30	52650	30	L	52	40	38	38,0	30	16	3,0	250	80	2
P92 CGL 0040 T40	10086	40	L	52	40	38	38,0	30	16	4,0	300	80	2
P92 CGL 0040 T50	10088	50	L	52	40	38	38,0	30	16	5,0	300	80	2
P92 CGL 0040 T60	19357	60	L	52	40	38	38,0	30	16	6,0	300	80	2
P92 CGR 0016 P15	33337	15	R	20	16	15	15,5	11	7	1,5	170	26	7
P92 CGR 0020 R15	34953	15	R	25	20	18	18,5	13	7	1,5	200	40	6
P92 CGR 0020 R20+25	33462	20	R	25	20	18	18,5	13	7	2,0+2,5	200	40	6
P92 CGR 0020 R30	10065	30	R	25	20	18	18,5	13	7	3,0	200	40	6
P92 CGR 0020 R40	10069	40	R	25	20	18	18,5	13	7	4,0	200	40	6
P92 CGR 0025 R20+25	33464	20	R	32	25	23	23,0	17	10	2,0+2,5	200	50	14
P92 CGR 0025 R30	10071	30	R	32	25	23	23,0	17	10	3,0	200	50	14
P92 CGR 0025 R40	10075	40	R	32	25	23	23,0	17	10	4,0	200	50	14
P92 CGR 0032 S20+25	33466	20	R	40	32	30	30,0	22	12	2,0+2,5	250	64	1
P92 CGR 0032 S30	10077	30	R	40	32	30	30,0	22	12	3,0	250	64	14
P92 CGR 0032 S40	10081	40	R	40	32	30	30,0	22	12	4,0	250	64	14
P92 CGR 0032 S50	10083	50	R	44	32	30	30,0	26	16	5,0	250	64	14
P92 CGR 0040 S30	52652	30	R	52	40	38	38,0	30	16	3,0	250	80	2
P92 CGR 0040 T40	10085	40	R	52	40	38	38,0	30	16	4,0	300	80	2
P92 CGR 0040 T50	10087	50	R	52	40	38	38,0	30	16	5,0	300	80	2
P92 CGR 0040 T60	19356	60	R	52	40	38	38,0	30	16	6,0	300	80	2

Fitting inserts

Torque p. 226, 227, 252 | Tech. Section p. 229 | pocket size p. 230 | p. 61 - 70 | p. 71 | p. 74-80 | Hard material machining p. 83-86

Inserts for grooving with one edge

KCTD

System P92

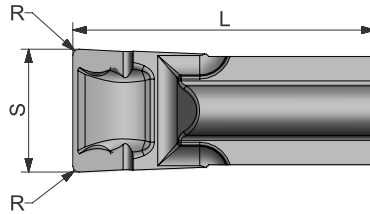
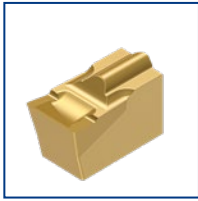

Enlarged view

WG300 Ref.	PM	KM	PM NANOSPEED	KM TILOX	pocket size	⌀	P	L	R	S +0,15	boring bar-Ø
	ID-Nr.	ID-Nr.	ID-Nr.	ID-Nr.							
KCTD 3	10899	20748	10902	29682	K30	N	3	9,5	0,2	3,0	12
KCTD 3	10899	20748	10902	29682	K30	N	4,5	9,5	0,2	3,0	16
KCTD 3 MAX	10903	26940	10906	31091	K30	N	5,5	12	0,2	3,0	12
KCTD 3 MAX	10903	26940	10906	31091	K30	N	7	12	0,2	3,0	16

Remark: Ground cutting edge with positive top-rake and wide chip-space.

Fitting tools, see below

Inserts for grooving and turning with one edge

KCTDS

System P92

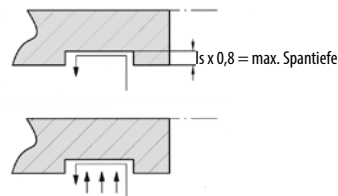
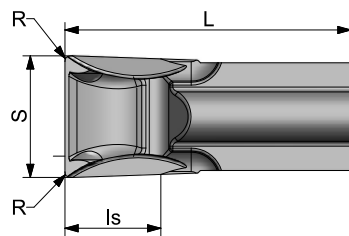

Enlarged view

WG300 Bezeichnung	PM	KM	PM NANOSPEED	KM TILOX	Plattensitzgröße	⌀	P	L	Is	R	S +0,15	boring bar-Ø
	ID-Nr.	ID-Nr.	ID-Nr.	ID-Nr.								
KCTDS 3	10907	20746	10910	35903	K30	N	3	9,5	1,5	0,2	3,0	12
KCTDS 3	10907	20746	10910	35903	K30	N	4,5	9,5	1,5	0,2	3,0	16
KCTDS 3 MAX	10911	14603	10914	12644	K30	N	5,5	12	1,5	0,2	3,0	12
KCTDS 3 MAX	10911	14603	10914	12644	K30	N	7	12	1,5	0,2	3,0	16

Remark: Chamfered cutting edge and ground turning edges for excellent chip control.

Fitting tools



p. 108



p. 229



p. 230



p.108

Inserts for grooving with one edge | Hard material machining

KCTD
System P92

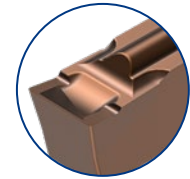
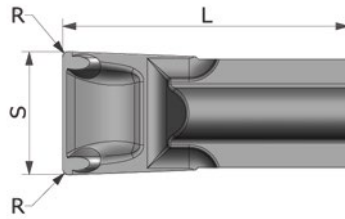
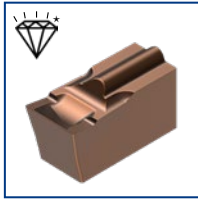

Enlarged view

WG302 Ref.	KM Hardlox 2 ID-Nr.	pocket size	(C)	P	L	R	S ^{+0,15}	boring bar-Ø
KCTD 3	38768	K30	N	3	9,5	0,2	3,0	12
KCTD 3	38768	K30	N	4,5	9,5	0,2	3,0	16
KCTD 3 MAX	38769	K30	N	5,5	12	0,2	3,0	12
KCTD 3 MAX	38769	K30	N	7	12	0,2	3,0	16

Remark: Inserts for small diameters.

Fitting tools



p. 229



p. 230



p. 232

Small boring bars with internal cooling for grooving and turning

P92 CGL..30C
System P92

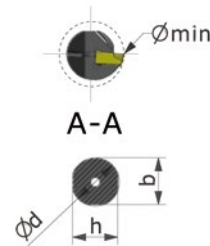
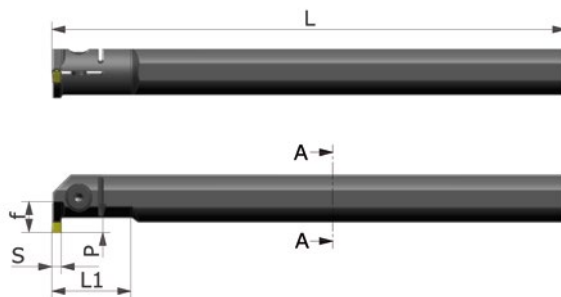

P92 CGR..30C
System P92-K



WG390 Ref.	ID-Nr.	pocket size	(C)	KCTD Ømin	d	h	b	f	P	S	L	L1	inserts	
P92 CGL 0012 M30C	10062	K30	L	15,5	12	11	-	9	3	3,0	150	22	7	KCTD 3 + KCTDS 3
P92 CGL 0012 M30C	10062	K30	L	18	12	11	-	11,5	5,5	3,0	150	22	7	KCTD 3 MAX + KCTDS 3 MAX
P92 CGL 0016 P30C	10064	K30	L	20	16	15	15,5	11	4,5	3,0	170	26	19	KCTD 3 + KCTDS 3
P92 CGL 0016 P30C	10064	K30	L	22,5	16	15	15,5	13,5	7	3,0	170	26	19	KCTD 3 MAX + KCTDS 3 MAX
P92 CGR 0012 M30C	10061	K30	R	15,5	12	11	-	9	3	3,0	150	22	7	KCTD 3 + KCTDS 3
P92 CGR 0012 M30C	10061	K30	R	18	12	11	-	11,5	5,5	3,0	150	22	7	KCTD 3 MAX + KCTDS 3 MAX
P92 CGR 0016 P30C	10063	K30	R	20	16	15	15,5	11	4,5	3,0	170	26	19	KCTD 3 + KCTDS 3
P92 CGR 0016 P30C	10063	K30	R	22,5	16	15	15,5	13,5	7	3,0	170	26	19	KCTD 3 MAX + KCTDS 3 MAX

Remark

Recommended turning speed range: $V_c \sim 40 \text{ m/min} \rightarrow 120 \text{ m/min}$
 Recommended turning feed range: $f \sim 0,02 \text{ mm/U} \rightarrow 0,08 \text{ mm/U}$

Fitting inserts: KCTD + KCTDS



p. 226, 227, 252



p. 229



p. 230



p. 107

P92-2 and P92-90 face grooving tools

for the range \varnothing 25 mm - ∞ mm

- ▶ *Cartridge-system*
- ▶ *Monoblock-system*
- ▶ *P92 2 TMS blade*

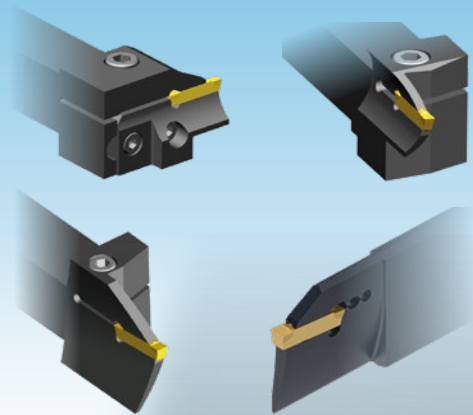

P92-2 and P92-90 face grooving tools

Modular cartridge system

Turning to the center or to the outside diameter is possible provided the 1st cut has been positioned inside the range \varnothing min - \varnothing max.

Face grooving: Cartridge choice

Each cartridge is designed for a certain diameter range. This range is marked as \varnothing min - \varnothing max.

5

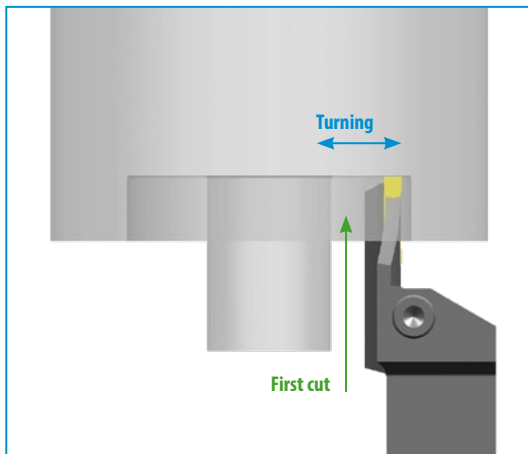

The drawing marks the collision-safe range \varnothing min - \varnothing max.

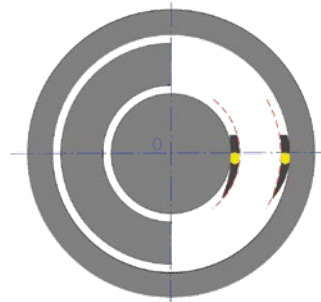

See page 244 for more details.

Damage caused when the 1st cut has been positioned incorrectly.

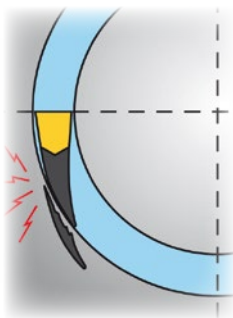

Shows the damage caused when the 1st cut is positioned within a smaller dimension than \varnothing min. **The outer face** of the cartridge collides with the component.

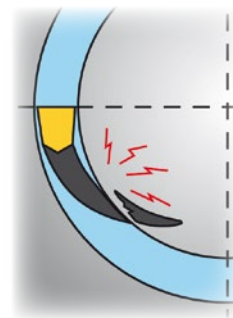

Shows the damage caused when the 1st cut is positioned outside \varnothing max, to the outer diameter. **The inner face** of the cartridge collides with the component.

P92-2 and P92-90 Face grooving tools

MONOBLOCK face grooving

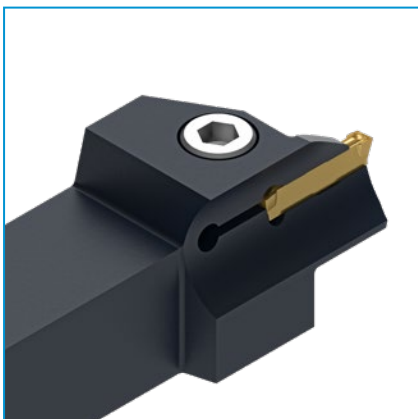
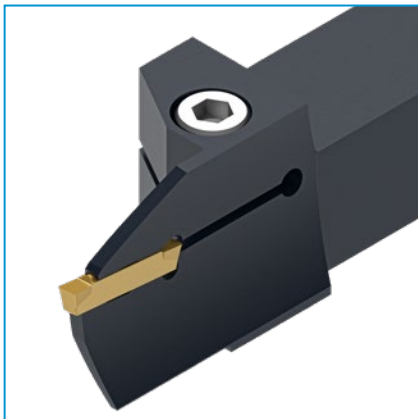
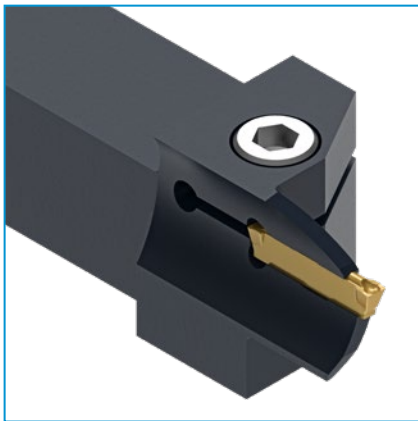

Characteristics

- ✓ The strong and rigid tool holder construction, provides for vibration free run and grants production reliability.
- ✓ All GripLock P92 inserts fit in the MONOBLOCK face grooving tool holders.
- ✓ In case of problems you can just select the most effective chip breaker from the assortment of applicable inserts.
- ✓ 40 right hand and 40 left hand different tool holders with shank dimensions 20 mm x 20 mm and 25 mm x 25 mm.

Recommendation

The first recommendation for face grooving is the **MTNS** chip breaker.

Technical specifications

Available width of inserts:

3 mm, 4 mm and 5 mm

Range of diameters:

25 mm - 450 mm

Depth of cut:

15 mm - 45 mm

Available chip breaker:

16



BTNG p. 69



BTNX p. 69



GTNS p. 67



MTNS/G p. 61 / 62



MTNZ p. 66



OTXC p. 70



OTXS p. 70



STNZ p. 63



VTNS p. 61



SCTD p. 79



CTD/R/L-IT p. 78

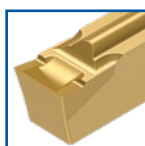

CTD/R/L-ALU p. 77



BTNNF p. 76



BTNN p. 74 + 75



RTNX p. 71



RTNG p. 71

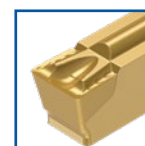

XTNS p. 68

Designation Code for face grooving cartridges

C92 LD 25 30 30

Tool family	Cutting width S = 3 mm
CW Rotation	∅ max (30 mm) biggest safe diameter
∅ min (25 mm) smallest safe diameter	

Designation Code for face grooving holders

P92 2 CXCRD 2020 K 30

Tool family	Cutting width S = 3 mm
Face grooving	ISO tool length
Face grooving tool CW / CCW for cartridges	Shank dimensions

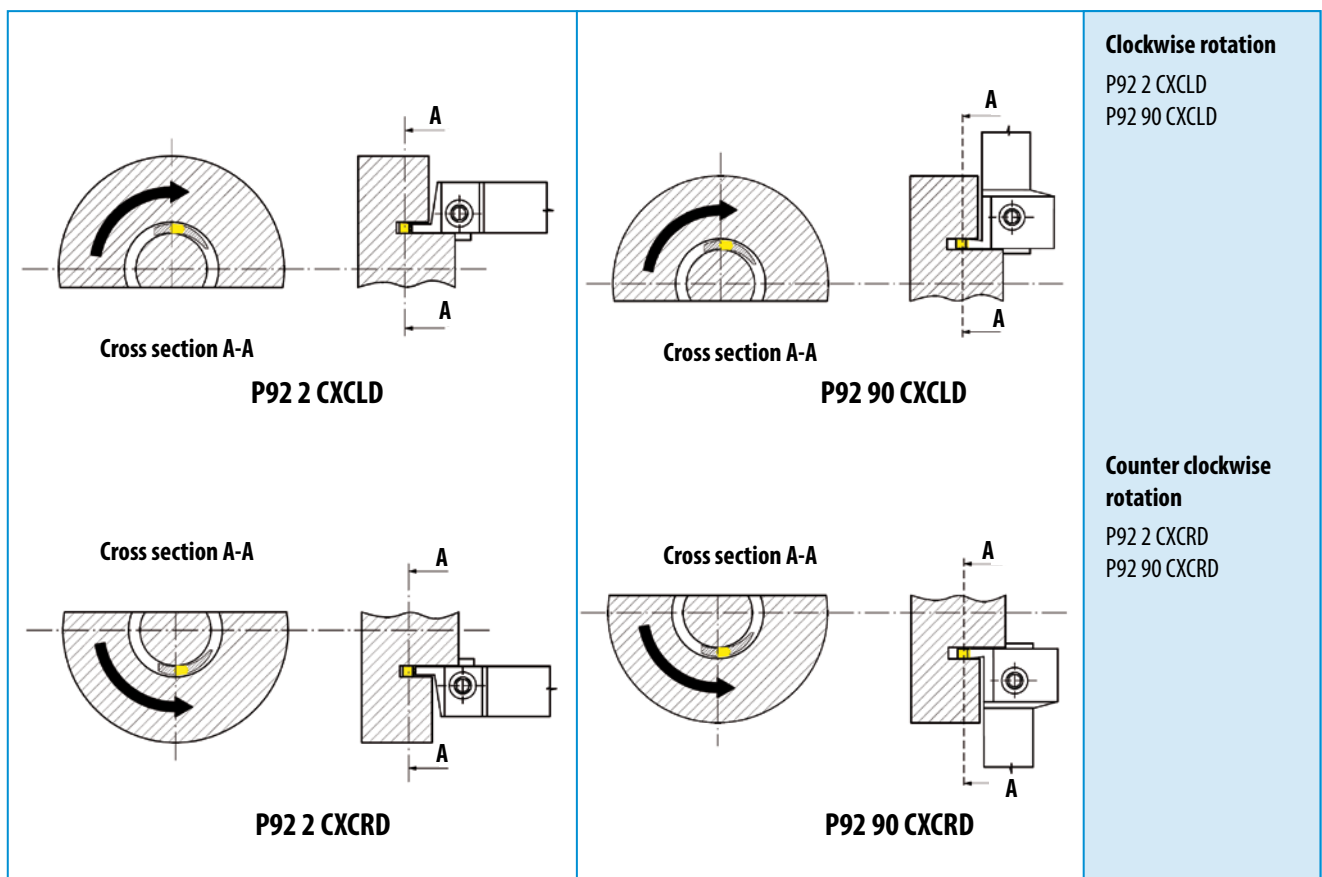

Tool holders with cartridges for face grooving

P92 2 CXCLD

System P92-2

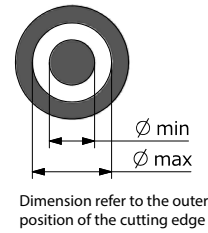
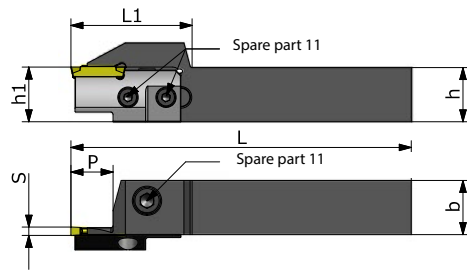

WG385 Cartridge holder Ref.	ID-Nr.	pocket size	⌀	h	h1	b	P	L	L1	
P92 2 CXCLD 2020 K 30	10119	30	L	20	20	20	15	125	44	11+2
P92 2 CXCLD 2525 M 30	10121	30	L	25	25	25	15	150	44	11+2

WG385 cartridge Ref.	ID-Nr.	pocket size	S	Ø min	Ø max
C92 LD 2530 30	10371	30	3	25	30
C92 LD 3035 30	10372	30	3	30	35
C92 LD 3542 30	10373	30	3	35	42
C92 LD 4250 30	10374	30	3	42	50
C92 LD 5058 30	10376	30	3	50	58
C92 LD 5866 30	10378	30	3	58	66
C92 LD 6675 30	10379	30	3	66	75
C92 LD 75100 30	10381	30	3	75	100
C92 LD 100200 30	10369	30	3	100	200
C92 LD 200300 30	43835	30	3	200	300

WG385 cartridge holder Ref.	ID-Nr.	pocket size	⌀	h	h1	b	P	L	L1	
P92 2 CXCLD 2020 K 40	10120	40	L	20	20	20	15	125	44	11+2
P92 2 CXCLD 2525 M 40	10122	40	L	25	25	25	15	150	44	11+2

WG385 cartridge Ref.	ID-Nr.	pocket size	S	Ø min	Ø max
C92 LD 4254 40	10375	40	4	42	54
C92 LD 5466 40	10377	40	4	54	66
C92 LD 6680 40	10380	40	4	66	80
C92 LD 80100 40	10382	40	4	80	100
C92 LD 100200 40	10370	40	4	100	200
C92 LD 200300 40	37200	40	4	200	300

Remark

Holder and cartridges fit together provided the final two figures of the Reference-Nr. are identical.

Example:

P92 2 CXCLD 2020 K **30** and C92 LD 3035 **30**
P92 2 CXCLD 2525 M **40** and C92 LD 6680 **40**

Fitting inserts

p. 226, 227, 252	p. 229	p. 230	p. 61-70	p. 71 p. 83-86

Tool holders with cartridges for face grooving

P92 2 CXCRD

System P92-2



RH holder

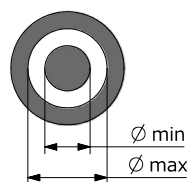
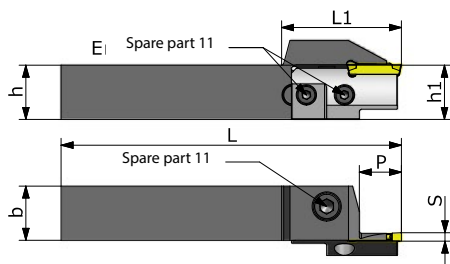

Dimension refer to the outer position of the cutting edge



RH cartridge

WG385 Cartridge holder Ref.	ID-Nr.	pocket size	()	h	h1	b	P	L	L1	
P92 2 CXCRD 2020 K 30	10123	30	R	20	20	20	15	125	44	11+2
P92 2 CXCRD 2525 M 30	10125	30	R	25	25	25	15	150	44	11+2

WG385 Cartridge Ref.	ID-Nr.	pocket size	S	Ø min	Ø max
C92 RD 2530 30	10385	30	3	25	30
C92 RD 3035 30	10386	30	3	30	35
C92 RD 3542 30	10387	30	3	35	42
C92 RD 4250 30	10388	30	3	42	50
C92 RD 5058 30	10390	30	3	50	58
C92 RD 5866 30	10392	30	3	58	66
C92 RD 6675 30	10393	30	3	66	75
C92 RD 75100 30	10395	30	3	75	100
C92 RD 100200 30	10383	30	3	100	200
C92 RD 200300 30	18356	30	3	200	300

WG385 Cartridge holder Ref.	ID-Nr.	pocket size	()	h	h1	b	P	L	L1	
P92 2 CXCRD 2020 K 40	10124	40	R	20	20	20	15	125	44	11+2
P92 2 CXCRD 2525 M 40	10126	40	R	25	25	25	15	150	44	11+2

WG385 Cartridge Ref.	ID-Nr.	pocket size	S	Ø min	Ø max
C92 RD 4254 40	10389	40	4	42	54
C92 RD 5466 40	10391	40	4	54	66
C92 RD 6680 40	10394	40	4	66	80
C92 RD 80100 40	10396	40	4	80	100
C92 RD 100200 40	10384	40	4	100	200
C92 RD 200300 40	21371	40	4	200	300

Remark

Holder and cartridges fit together provided the final two figures of the Reference-Nr. are identical.

Example:

P92 2 CXCRD 2020 K **30** and C92 RD 3035 **30**
 P92 2 CXCRD 2525 M **40** and C92 RD 6680 **40**

Fitting inserts

p. 226, 227, 252
 p. 229
 p. 230
 p. 61-70
 p. 71
 p. 83-86

Tool holders with cartridges for face grooving

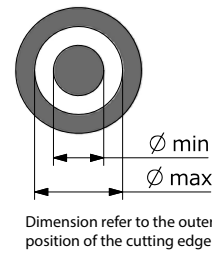
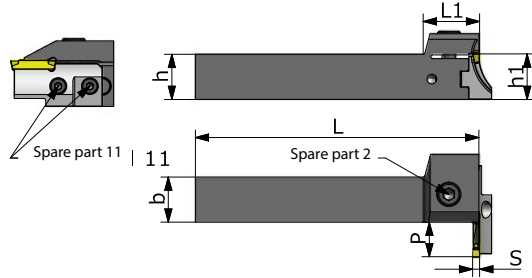

WG385 Cartridge holder Ref.	ID-Nr.	Plattensitzgröße	()	h	h1	b	P	L	L1	
P92 90 CXCLD 2020 K 30	10127	30	L	20	20	20	15	125	24	11+2
P92 90 CXCLD 2525 M 30	10129	30	L	25	25	25	15	150	24	11+2

WG385 Cartridge Ref.	ID-Nr.	pocket size	S	Ø min	Ø max
C92 LD 2530 30	10371	30	3	25	30
C92 LD 3035 30	10372	30	3	30	35
C92 LD 3542 30	10373	30	3	35	42
C92 LD 4250 30	10374	30	3	42	50
C92 LD 5058 30	10376	30	3	50	58
C92 LD 5866 30	10378	30	3	58	66
C92 LD 6675 30	10379	30	3	66	75
C92 LD 75100 30	10381	30	3	75	100
C92 LD 100200 30	10369	30	3	100	200
C92 LD 200300 30	43835	30	3	200	300

WG385 Cartridge holder Ref.	ID-Nr.	pocket size	()	h	h1	b	P	L	L1	
P92 90 CXCLD 2020 K 40	10128	40	L	20	20	20	15	125	24	11+2
P92 90 CXCLD 2525 M 40	10130	40	L	25	25	25	15	150	24	11+2

WG385 Cartridge Ref.	ID-Nr.	pocket size	S	Ø min	Ø max
C92 LD 4254 40	10375	40	4	42	54
C92 LD 5466 40	10377	40	4	54	66
C92 LD 6680 40	10380	40	4	66	80
C92 LD 80100 40	10382	40	4	80	100
C92 LD 100200 40	10370	40	4	100	200
C92 LD 200300 40	37200	40	4	200	300

Remark

Holder and cartridges fit together provided the first two figures of the Reference-Nr. are identical.

Example:

P92 90 CXCLD 2020 K **30** and C92 LD 3035 **30**
P92 90 CXCLD 2525 M **40** and C92 LD 6680 **40**

Fitting inserts

Torque p. 226, 227, 252 | Tech. Section p. 229 | pocket size p. 230 | Hard material machining p. 61-70, p. 71, p. 83-86

Tool holders with cartridges for face grooving

P92 90 CXCRD

System P92-90

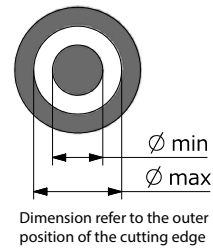
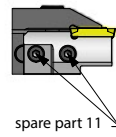
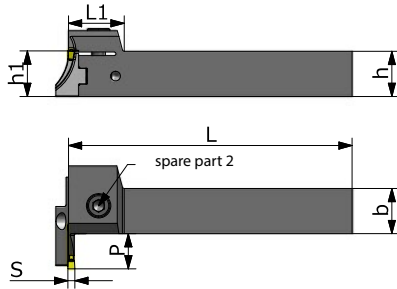

WG385 Cartridge holder Ref.	ID-Nr.	pocket size	()	h	h1	b	P	L	L1	
P92 90 CXCRD 2020 K 30	10131	30	R	20	20	20	15	125	24	11+2
P92 90 CXCRD 2525 M 30	10133	30	R	25	25	25	15	150	24	11+2

WG385 Cartridge Ref.	ID-Nr.	pocket size	S	Ø min	Ø max
C92 RD 2530 30	10385	30	3	25	30
C92 RD 3035 30	10386	30	3	30	35
C92 RD 3542 30	10387	30	3	35	42
C92 RD 4250 30	10388	30	3	42	50
C92 RD 5058 30	10390	30	3	50	58
C92 RD 5866 30	10392	30	3	58	66
C92 RD 6675 30	10393	30	3	66	75
C92 RD 75100 30	10395	30	3	75	100
C92 RD 100200 30	10383	30	3	100	200
C92 RD 200300 30	18356	30	3	200	300

WG385 Cartridge holder Ref.	ID-Nr.	pocket size	()	h	h1	b	P	L	L1	
P92 90 CXCRD 2020 K 40	10132	40	R	20	20	20	15	125	24	11+2
P92 90 CXCRD 2525 M 40	10134	40	R	25	25	25	15	150	24	11+2

WG385 Cartridge Ref.	ID-Nr.	pocket size	S	Ø min	Ø max
C92 RD 4254 40	10389	40	4	42	54
C92 RD 5466 40	10391	40	4	54	66
C92 RD 6680 40	10394	40	4	66	80
C92 RD 80100 40	10396	40	4	80	100
C92 RD 100200 40	10384	40	4	100	200
C92 RD 200300 40	21371	40	4	200	300

Remark

Holder and cartridges fit together provided the final two figures of the Reference-Nr. are identical.

Example:

P92 90 CXCRD 2020 K **30** and C92 RD 3035 **30**
 P92 90 CXCRD 2525 M **40** and C92 RD 6680 **40**

Fitting inserts

Torque p. 226, 227, 252 | Tech. Section p. 229 | pocket size p. 230 | Hard material machining p. 61-70, p. 71, p. 83-86

Designation Code for MONOBLOCK face grooving tools

P92 2 CXCB R 2020 K 30 30 A

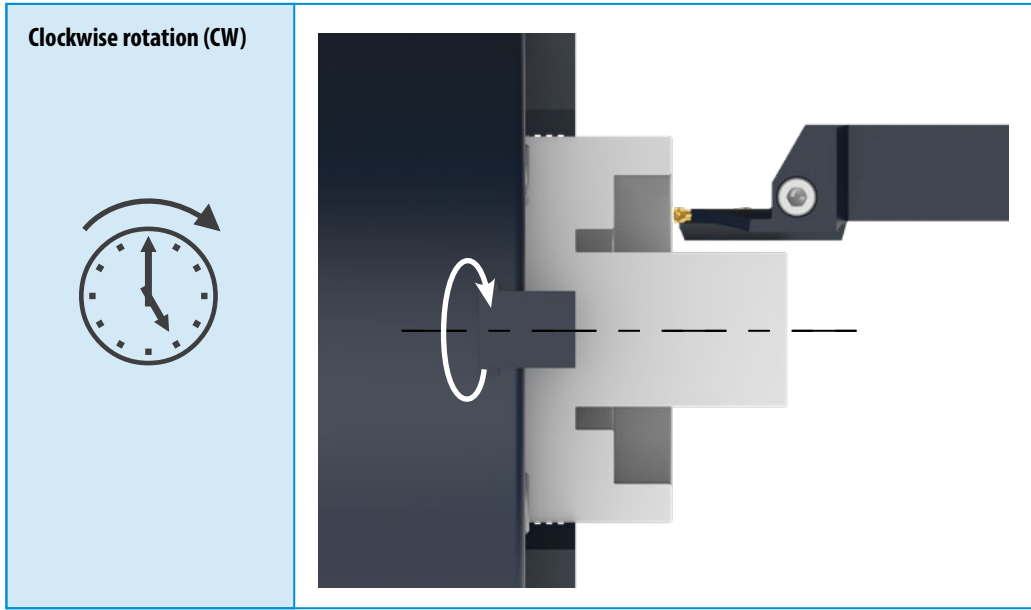
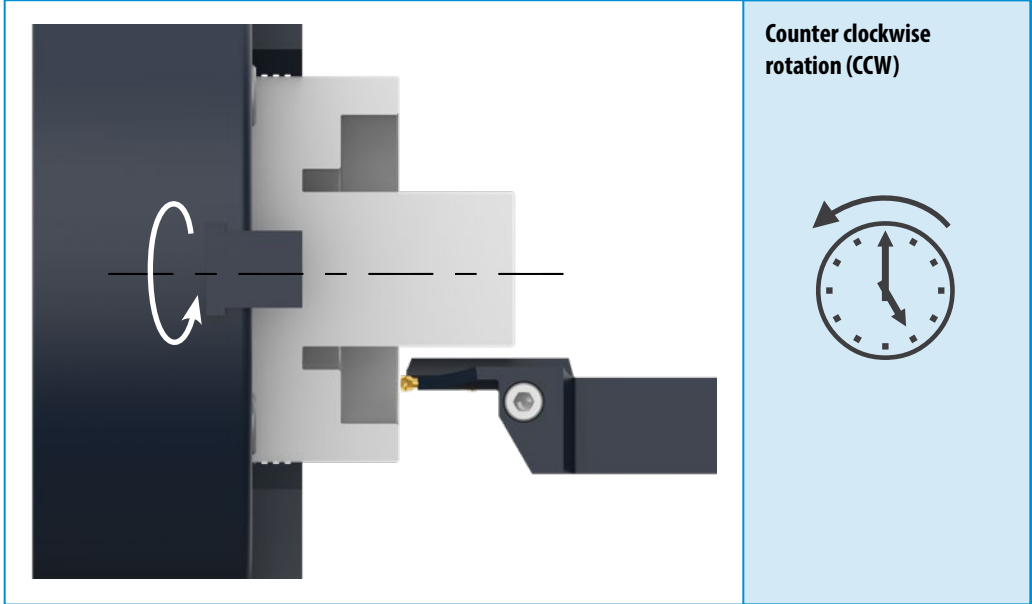
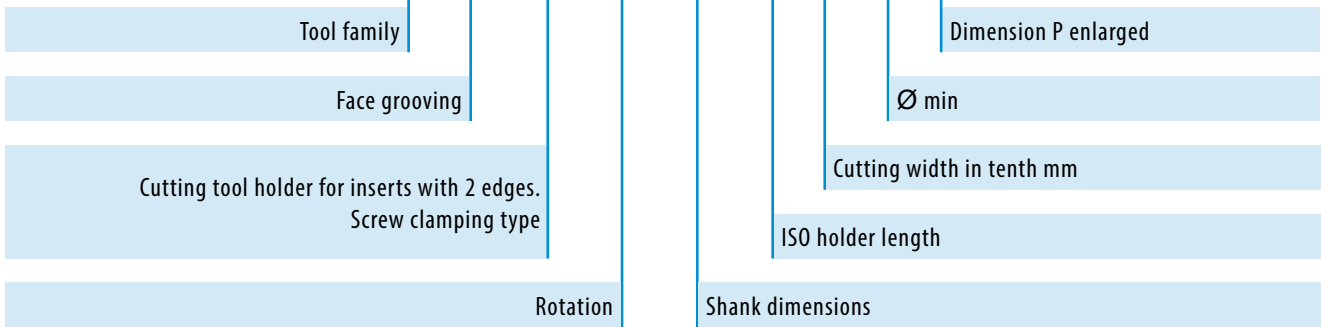

MONOBLOCK Face grooving tool holders for cutting width 3 mm

P92 2 CXCBL

System P92-2

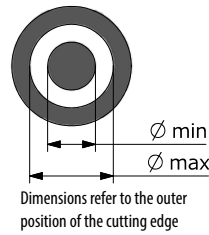
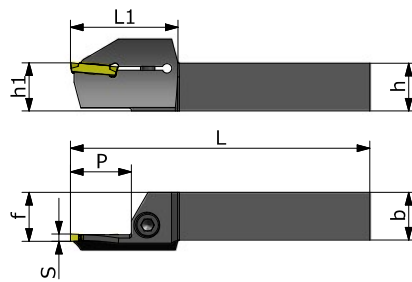
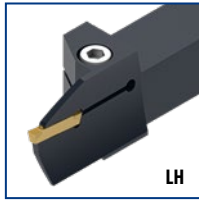

P92 2 CXCBR

System P92-2

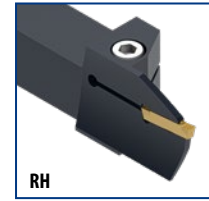

WG388 Ref.	ID-Nr.	pocket size	(C)	Ø min	Ø max	h	h1	b	f	P	S	L	L1	
P92 2 CXCBL 2020 K 30 25	30164	30	L	25	30	20	20	20	20,5	15	3	125	35	2
P92 2 CXCBL 2020 K 30 30	30167	30	L	30	38	20	20	20	20,5	15	3	125	35	2
P92 2 CXCBL 2020 K 30 38	30169	30	L	38	48	20	20	20	20,5	15	3	125	35	2
P92 2 CXCBL 2020 K 30 48	30170	30	L	48	60	20	20	20	20,5	15	3	125	35	2
P92 2 CXCBL 2020 K 30 60	30171	30	L	60	75	20	20	20	20,5	22	3	125	43	2
P92 2 CXCBL 2020 K 30 75	30172	30	L	75	100	20	20	20	20,5	25	3	125	45	2
P92 2 CXCBL 2020 K 30 100	30173	30	L	100	200	20	20	20	20,5	25	3	125	45	2
P92 2 CXCBL 2525 M 30 25	30174	30	L	25	30	25	25	25	25,5	15	3	150	35	2
P92 2 CXCBL 2525 M 30 30	30175	30	L	30	38	25	25	25	25,5	15	3	150	35	2
P92 2 CXCBL 2525 M 30 38	30179	30	L	38	48	25	25	25	25,5	15	3	150	35	2
P92 2 CXCBL 2525 M 30 48	30181	30	L	48	60	25	25	25	25,5	15	3	150	35	2
P92 2 CXCBL 2525 M 30 60	30182	30	L	60	75	25	25	25	25,5	22	3	150	43	2
P92 2 CXCBL 2525 M 30 75	30184	30	L	75	100	25	25	25	25,5	25	3	150	45	2
P92 2 CXCBL 2525 M 30 100	30185	30	L	100	200	25	25	25	25,5	25	3	150	45	2
P92 2 CXCBR 2020 K 30 25	29786	30	R	25	30	20	20	20	20,5	15	3	125	35	2
P92 2 CXCBR 2020 K 30 30	29787	30	R	30	38	20	20	20	20,5	15	3	125	35	2
P92 2 CXCBR 2020 K 30 38	29788	30	R	38	48	20	20	20	20,5	15	3	125	35	2
P92 2 CXCBR 2020 K 30 48	29789	30	R	48	60	20	20	20	20,5	15	3	125	35	2
P92 2 CXCBR 2020 K 30 60	29790	30	R	60	75	20	20	20	20,5	22	3	125	43	2
P92 2 CXCBR 2020 K 30 75	29791	30	R	75	100	20	20	20	20,5	25	3	125	45	2
P92 2 CXCBR 2020 K 30 100	29792	30	R	100	200	20	20	20	20,5	25	3	125	45	2
P92 2 CXCBR 2525 M 30 25	29793	30	R	25	30	25	25	25	25,5	15	3	150	35	2
P92 2 CXCBR 2525 M 30 30	29794	30	R	30	38	25	25	25	25,5	15	3	150	35	2
P92 2 CXCBR 2525 M 30 38	29795	30	R	38	48	25	25	25	25,5	15	3	150	35	2
P92 2 CXCBR 2525 M 30 48	29796	30	R	48	60	25	25	25	25,5	15	3	150	35	2
P92 2 CXCBR 2525 M 30 60	29797	30	R	60	75	25	25	25	25,5	22	3	150	43	2
P92 2 CXCBR 2525 M 30 75	29798	30	R	75	100	25	25	25	25,5	25	3	150	45	2
P92 2 CXCBR 2525 M 30 100	29799	30	R	100	200	25	25	25	25,5	25	3	150	45	2

5

Fitting inserts

- Torque: p. 226, 227, 252
- Tech. Section: p. 229
- pocket size: p. 230
- Hard material machining: p. 61-70
- p. 71
- p. 83-86

MONOBLOCK Face grooving tool holders for cutting width 4 mm

P92 2 CXCBL

System P92-2

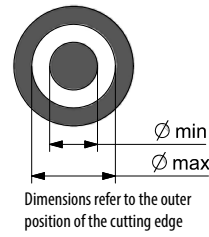
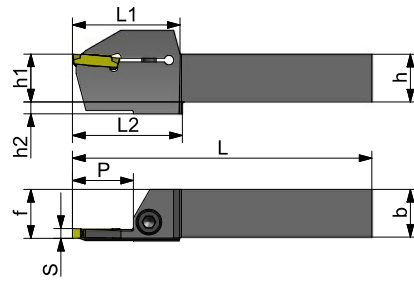
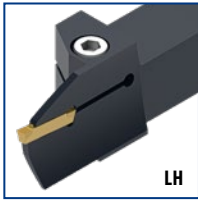

P92 2 CXCBR

System P92-2

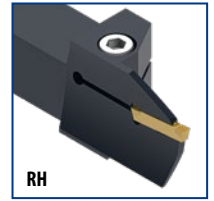

WG388 Ref.	ID-Nr.	pocket size	↺	Ø min	Ø max	h	h1	h2	b	f	P	S	L	L1	L2	
P92 2 CXCBL 2020 K 40 34	30186	40	L	34	40	20	20		20	20,5	20	4	125	41	2	
P92 2 CXCBL 2020 K 40 40	30187	40	L	40	48	20	20		20	20,5	25	4	125	45	2	
P92 2 CXCBL 2020 K 40 48	30188	40	L	48	60	20	20		20	20,5	25	4	125	45	2	
P92 2 CXCBL 2020 K 40 60	30189	40	L	60	75	20	20		20	20,5	25	4	125	45	2	
P92 2 CXCBL 2020 K 40 75	30190	40	L	75	150	20	20		20	20,5	25	4	125	45	2	
P92 2 CXCBL 2020 K 40 150	29718	40	L	150	450	20	20	5	20	20,5	25	4	125	45	46	2
P92 2 CXCBL 2525 M 40 34	30192	40	L	34	40	25	25		25	25,5	20	4	150	41	2	
P92 2 CXCBL 2525 M 40 40	30193	40	L	40	48	25	25		25	25,5	25	4	150	45	2	
P92 2 CXCBL 2525 M 40 48	30194	40	L	48	60	25	25		25	25,5	25	4	150	45	2	
P92 2 CXCBL 2525 M 40 60	30195	40	L	60	75	25	25		25	25,5	25	4	150	45	2	
P92 2 CXCBL 2525 M 40 75	30196	40	L	75	150	25	25		25	25,5	25	4	150	45	2	
P92 2 CXCBL 2525 M 40 150	30197	40	L	150	450	25	25		25	25,5	25	4	150	45	2	
P92 2 CXCBL 2525 M 40 450	30198	40	L	450	∞	25	25	5	25	25,5	25	4	150	45	46	2
P92 2 CXCBR 2020 K 40 34	29742	40	R	34	40	20	20		20	20,5	20	4	125	41	2	
P92 2 CXCBR 2020 K 40 40	29743	40	R	40	48	20	20		20	20,5	25	4	125	45	2	
P92 2 CXCBR 2020 K 40 48	29744	40	R	48	60	20	20		20	20,5	25	4	125	45	2	
P92 2 CXCBR 2020 K 40 60	29745	40	R	60	75	20	20		20	20,5	25	4	125	45	2	
P92 2 CXCBR 2020 K 40 75	29746	40	R	75	150	20	20		20	20,5	25	4	125	45	2	
P92 2 CXCBR 2020 K 40 150	29717	40	R	150	450	20	20	5	20	20,5	25	4	125	45	46	2
P92 2 CXCBR 2525 M 40 34	29747	40	R	34	40	25	25		25	25,5	20	4	150	41	2	
P92 2 CXCBR 2525 M 40 40	29748	40	R	40	48	25	25		25	25,5	25	4	150	45	2	
P92 2 CXCBR 2525 M 40 48	29749	40	R	48	60	25	25		25	25,5	25	4	150	45	2	
P92 2 CXCBR 2525 M 40 60	29750	40	R	60	75	25	25		25	25,5	25	4	150	45	2	
P92 2 CXCBR 2525 M 40 75	29751	40	R	75	150	25	25		25	25,5	25	4	150	45	2	
P92 2 CXCBR 2525 M 40 150	29719	40	R	150	450	25	25		25	25,5	25	4	150	45	2	
P92 2 CXCBR 2525 M 40 450	29721	40	R	450	∞	25	25	5	25	25,5	25	4	150	45	46	2

Fitting inserts

Torque p. 226, 227, 252
 Tech. Section p. 229
 pocket size p. 230
 p. 61-70
 Hard material machining p. 71 p. 83-86

MONOBLOCK Face grooving tool holders for cutting width 5 mm

P92 2 CXCBL

System P92-2

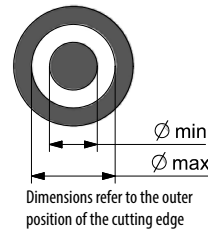
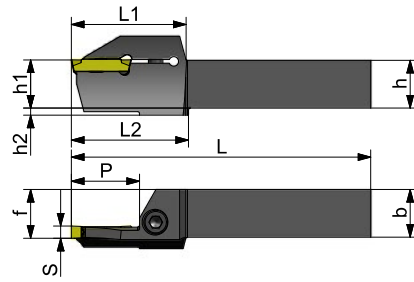
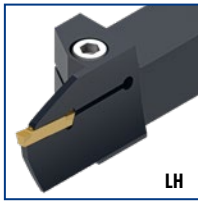

P92 2 CXCBR

System P92-2

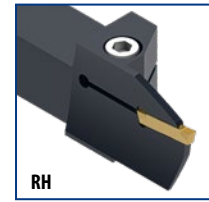

WG388 Ref.	ID-Nr.	pocket size	()	Ø min	Ø max	h	h1	h2	b	f	P	S	L	L1	L2	
P92 2 CXCBL 2020 K 50 42	28296	50	L	42	55	20	20		20	20,5	25	5	125	45		2
P92 2 CXCBL 2020 K 50 55	30199	50	L	55	75	20	20		20	20,5	25	5	125	45		2
P92 2 CXCBL 2020 K 50 75	29714	50	L	75	130	20	20	3	20	20,5	28	5	125	48	49	2
P92 2 CXCBL 2525 M 50 42	28298	50	L	42	55	25	25		25	25,5	25	5	150	45		2
P92 2 CXCBL 2525 M 50 55	30201	50	L	55	75	25	25		25	25,5	25	5	150	45		2
P92 2 CXCBL 2525 M 50 75	30202	50	L	75	130	25	25		25	25,5	32	5	150	52		2
P92 2 CXCBL 2525 M 50 75A	30203	50	L	75	130	25	25		25	25,5	40	5	150	60		2
P92 2 CXCBL 2525 M 50 130	30204	50	L	130	200	25	25	5	25	25,5	32	5	150	52	53	2
P92 2 CXCBL 2525 M 50 130A	30205	50	L	130	200	25	25	5	25	25,5	40	5	150	60	61	2
P92 2 CXCBL 2525 M 50 200	30207	50	L	200	450	25	25	5	25	25,5	32	5	150	52	53	2
P92 2 CXCBL 2525 M 50 200A	30208	50	L	200	450	25	25	5	25	25,5	45	5	150	65	66	2
P92 2 CXCBL 2525 M 50 450	30210	50	L	450	∞	25	25	5	25	25,5	32	5	150	52	53	2
P92 2 CXCBL 2525 M 50 450A	30209	50	L	450	∞	25	25	5	25	25,5	45	5	150	65	66	2
P92 2 CXCBR 2020 K 50 42	28295	50	R	42	55	20	20		20	20,5	25	5	125	45		2
P92 2 CXCBR 2020 K 50 55	29774	50	R	55	75	20	20		20	20,5	25	5	125	45		2
P92 2 CXCBR 2020 K 50 75	29713	50	R	75	130	20	20	3	20	20,5	28	5	125	48	49	2
P92 2 CXCBR 2525 M 50 42	28297	50	R	42	55	25	25		25	25,5	25	5	150	45		2
P92 2 CXCBR 2525 M 50 55	29775	50	R	55	75	25	25		25	25,5	25	5	150	45		2
P92 2 CXCBR 2525 M 50 75	29776	50	R	75	130	25	25		25	25,5	32	5	150	52		2
P92 2 CXCBR 2525 M 50 75A	29777	50	R	75	130	25	25		25	25,5	40	5	150	60		2
P92 2 CXCBR 2525 M 50 130	29780	50	R	130	200	25	25	5	25	25,5	32	5	150	52	53	2
P92 2 CXCBR 2525 M 50 130A	29781	50	R	130	200	25	25	5	25	25,5	40	5	150	60	61	2
P92 2 CXCBR 2525 M 50 200	29782	50	R	200	450	25	25	5	25	25,5	32	5	150	52	53	2
P92 2 CXCBR 2525 M 50 200A	29784	50	R	200	450	25	25	5	25	25,5	45	5	150	65	66	2
P92 2 CXCBR 2525 M 50 450	29715	50	R	450	∞	25	25	5	25	25,5	32	5	150	52	53	2
P92 2 CXCBR 2525 M 50 450A	29785	50	R	450	∞	25	25	5	25	25,5	45	5	150	65	66	2

How to write an order:

1 pc. P92 2 CXCBR 2020 K 50 42 or: **1 pc. ID-Nr. 28295** recommended
 10 pcs. RTNX 525 KM TILOX or: **10 pcs. ID-Nr. 13414**



p. 226, 227, 252

p. 229

p. 230

p. 61-70

p. 71

p. 83-86

Blades for face grooving

P92 2 TMS

System P92-2

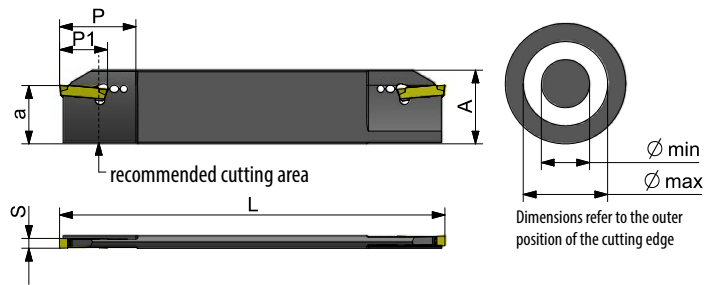

WG311 Ref.	ID-Nr.	pocket size	⌀	Ømin	Ømax	A	a	P	P1	S	L	
P92 2 TMS 32 4 85 R	44531	40	R	85	160	32	25,0	32	18,5	4,0	160	28
P92 2 TMS 32 4 140 R	44542	40	R	140	260	32	25,0	32	18,5	4,0	160	28
P92 2 TMS 32 4 240 R	44543	40	R	240	~	32	25,0	32	18,5	4,0	160	28
P92 2 TMS 32 5 85 R	44538	50	R	85	160	32	25,0	35	23,5	5,0	160	28
P92 2 TMS 32 5 140 R	44540	50	R	140	260	32	25,0	35	23,5	5,0	160	28
P92 2 TMS 32 5 240 R	44541	50	R	240	~	32	25,0	35	23,5	5,0	160	28

Remark: Blades and tool blocks with the same "A" dimension fit together.
For optimal stability, always keep the sword as short and compact as possible.

Changing insert
P92 2 TMS
Easy and fast

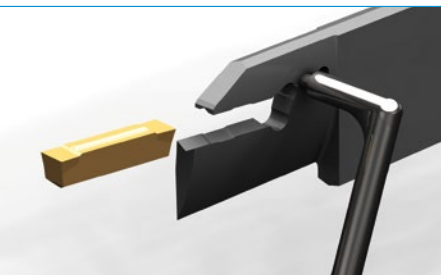

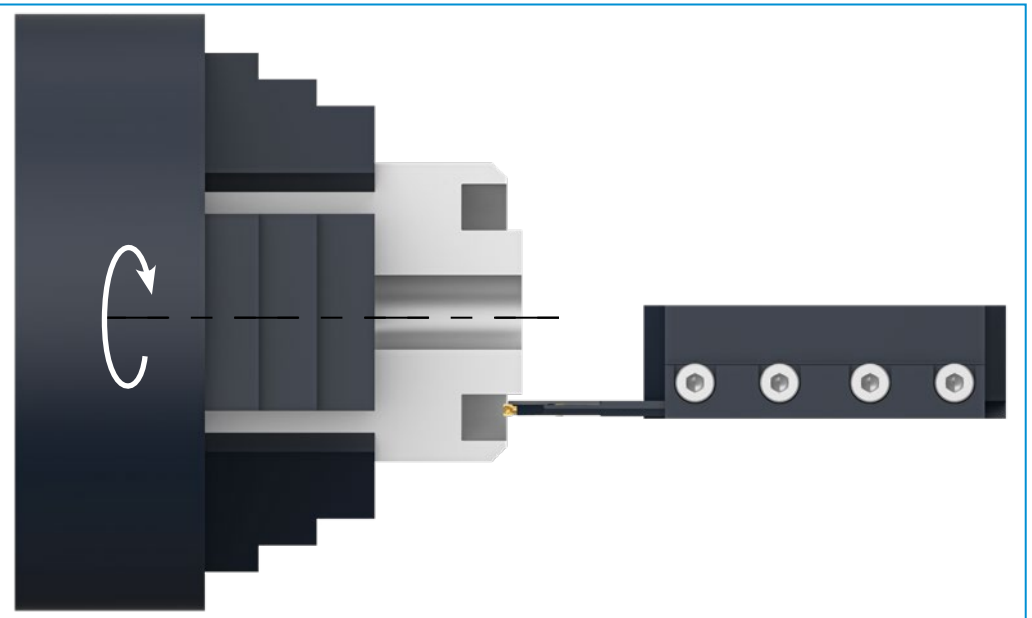

Application
P92 2 TMS 32





Fitting inserts and tool blocks

- 

Tech. Section
p. 229
- 

pocket size
p. 230
- 

p. 61-70
- 

Hard material machining
p. 71
- 

p. 83-86
- 

p. 182, 183

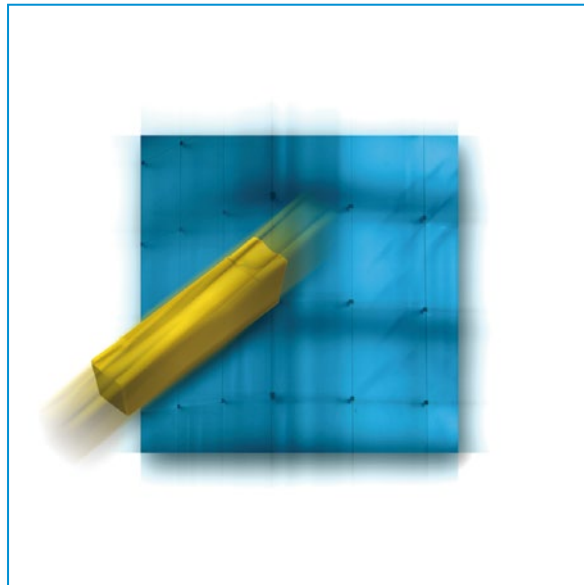
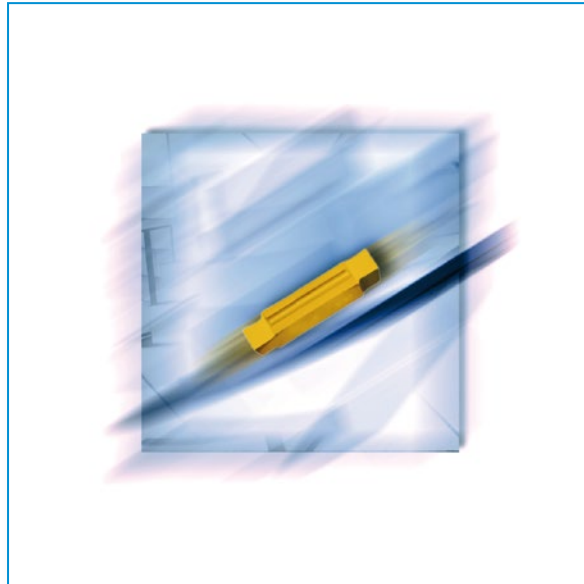

P92 P - Precision system

The precision system for machining

- ▶ *Precision grooving*
- ▶ *Precision copying*
- ▶ *Precision threading*
- ▶ *Precision turning*

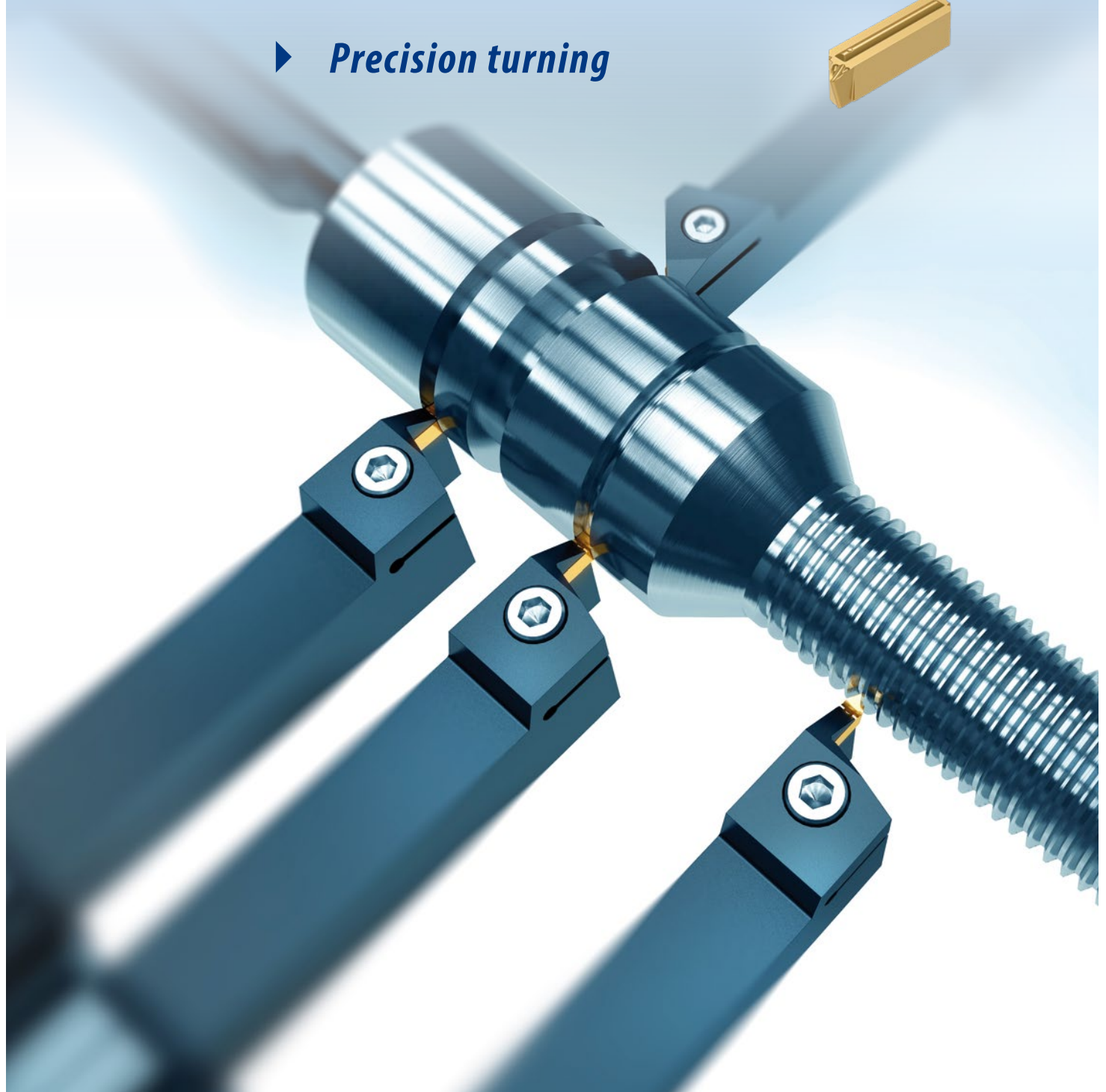
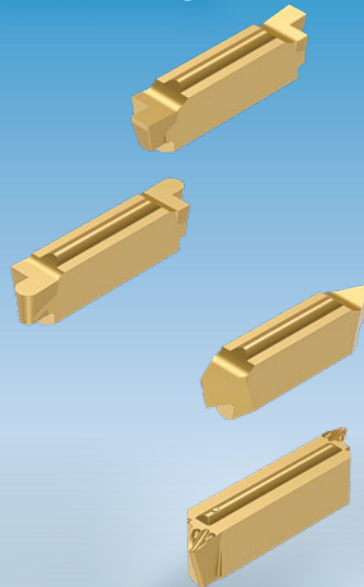

P92 P - Precision system

The precision system for machining

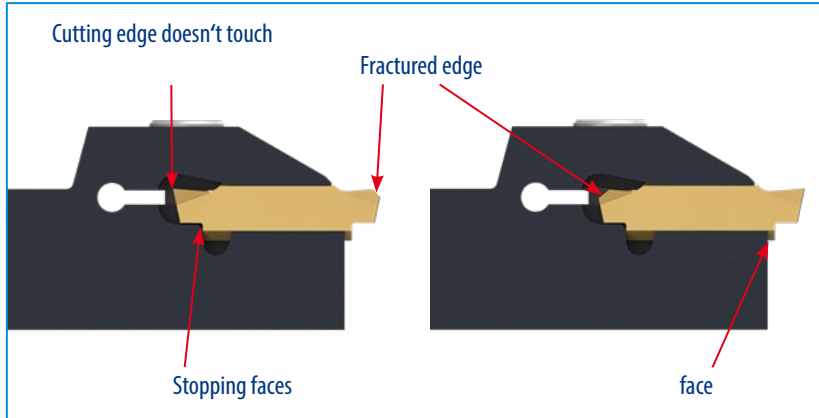

- ✓ Precise repositioning of cutting edge
- ✓ No loss! In case of fractured edge, the so far unused edge can be employed.

- ✓ Long guide surfaces between insert and pocket achieve a solid unit and therefore lead to a perfect straight run.

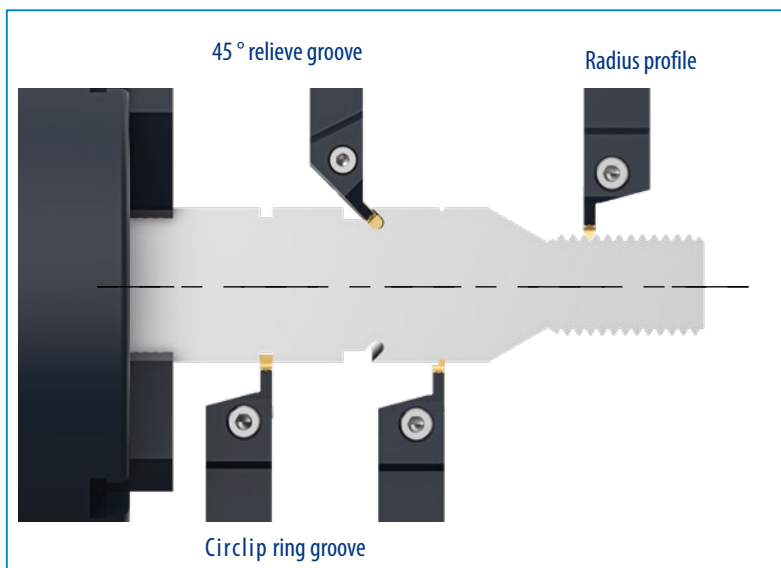
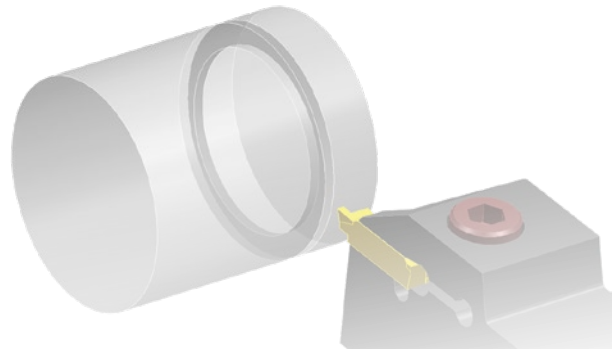

- ✓ Many applications

Precision grooving inserts (DIN 471)

P92 P OTX..R/L

System P92-P

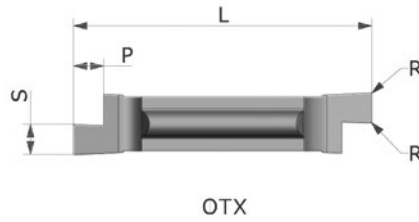
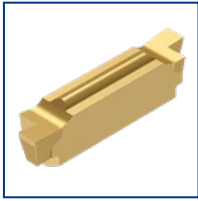

Inserts for CW run



OTX...L

Inserts for CCW run



OTX...R



Enlarged view

WG260 Ref.	KM ID-Nr.	PM NANOSPEED ID-Nr.	KM NANOSPEED ID-Nr.	pocket size	⌀	L ^{-0,1}	P	R		S ^{-0,05}
OTX 4 050L	23940	23961	23960	P40	L	19,2	1,0	0,05	0,50	0,57
OTX 4 060L	23941	23965	23964	P40	L	19,2	1,0	0,05	0,60	0,67
OTX 4 070L	23942	23969	23968	P40	L	19,2	1,5	0,05	0,70	0,77
OTX 4 080L	23943	23973	23972	P40	L	19,2	1,5	0,05	0,80	0,87
OTX 4 090L	11047	11053	11049	P40	L	19,2	1,5	0,1	0,90	0,97
OTX 4 110L	11055	11061	11057	P40	L	19,2	1,5	0,1	1,10	1,24
OTX 4 130L	11063	11069	11065	P40	L	19,2	1,5	0,1	1,30	1,44
OTX 4 160L	11071	11077	11073	P40	L	19,2	2,0	0,1	1,60	1,74
OTX 4 185L	11079	11085	11081	P40	L	19,2	2,0	0,1	1,85	1,99
OTX 4 215L	11087	11093	11089	P40	L	19,2	2,5	0,1	2,15	2,29
OTX 4 265L	11095	11101	11097	P40	L	19,2	2,5	0,1	2,65	2,79
OTX 4 315L	11111	11117	11113	P40	L	19,2	2,5	0,1	3,15	3,29
OTX 5 415L	11161	11167	11163	P50	L	23,6	3,5	0,1	4,15	4,29
OTX 4 050R	23939	23963	23962	P40	R	19,2	1,0	0,05	0,50	0,57
OTX 4 060R	23938	23967	23966	P40	R	19,2	1,0	0,05	0,60	0,67
OTX 4 070R	23937	23971	23970	P40	R	19,2	1,5	0,05	0,70	0,77
OTX 4 080R	23936	23975	23974	P40	R	19,2	1,5	0,05	0,80	0,87
OTX 4 090R	11046	11052	11048	P40	R	19,2	1,5	0,1	0,90	0,97
OTX 4 110R	11054	11060	11056	P40	R	19,2	1,5	0,1	1,10	1,24
OTX 4 130R	11062	11068	11064	P40	R	19,2	1,5	0,1	1,30	1,44
OTX 4 160R	11070	11076	11072	P40	R	19,2	2,0	0,1	1,60	1,74
OTX 4 185R	11078	11084	11080	P40	R	19,2	2,0	0,1	1,85	1,99
OTX 4 215R	11086	11092	11088	P40	R	19,2	2,5	0,1	2,15	2,29
OTX 4 265R	11094	11100	11096	P40	R	19,2	2,5	0,1	2,65	2,79
OTX 4 315R	11110	11116	11112	P40	R	19,2	2,5	0,1	3,15	3,29
OTX 5 415R	11160	11166	11162	P50	R	23,6	3,5	0,1	4,15	4,29

How to write an order:
 1 pc. P92 P CXCBL 0808 K 4 page 133 pocket size P40
 10 pcs. OTX 4050 L KM page 125 pocket size P40



p. 135, 137 p. 229 p. 230 p. 232 p. 133-134 p. 135 p. 136 p. 137 p. 137 p. 195

Full radius grooving and copying inserts

P92 P OTX R..R/L
System P92-P

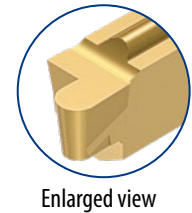
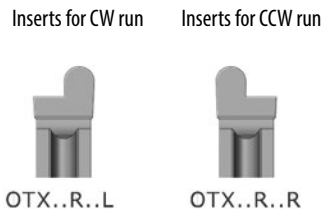
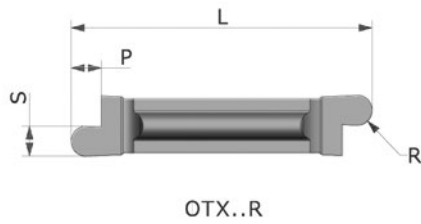

WG260 Ref.	KM ID-Nr.	PM NANOSPEED ID-Nr.	KM NANOSPEED ID-Nr.	pocket size	()	L ^{-0.1}	P	R	S ^{+0.05}
OTX 4 R 050L	23952	23957	23956	P40	L	19,2	2,0	0,50	1,00
OTX 4 R 075L	29648	25285	29651	P40	L	19,2	2,0	0,75	1,50
OTX 4 R 100L	11143	11149	11145	P40	L	19,2	3,0	1,00	2,00
OTX 4 R 125L	29649	25286	29653	P40	L	19,2	3,0	1,25	2,50
OTX 4 R 150L	11151	11157	11153	P40	L	19,2	3,0	1,50	3,00
OTX 5 R 200L	11171	11177	11173	P50	L	23,6	4,0	2,00	4,00
OTX 6 R 250L	11181	11187	11183	P50	L	23,6	4,0	2,50	5,00
OTX 6 R 300L	11189	11195	11191	P50	L	23,6	4,0	3,00	6,00
OTX 4 R 050R	23953	23959	23958	P40	R	19,2	2,0	0,50	1,00
OTX 4 R 075R	29642	25284	29652	P40	R	19,2	2,0	0,75	1,50
OTX 4 R 100R	11142	11148	11144	P40	R	19,2	3,0	1,00	2,00
OTX 4 R 125R	29650	25287	29654	P40	R	19,2	3,0	1,25	2,50
OTX 4 R 150R	11150	11156	11152	P40	R	19,2	3,0	1,50	3,00
OTX 5 R 200R	11170	11176	11172	P50	R	23,6	4,0	2,00	4,00
OTX 6 R 250R	11180	11186	11182	P50	R	23,6	4,0	2,50	5,00
OTX 6 R 300R	11188	11194	11190	P50	R	23,6	4,0	3,00	6,00

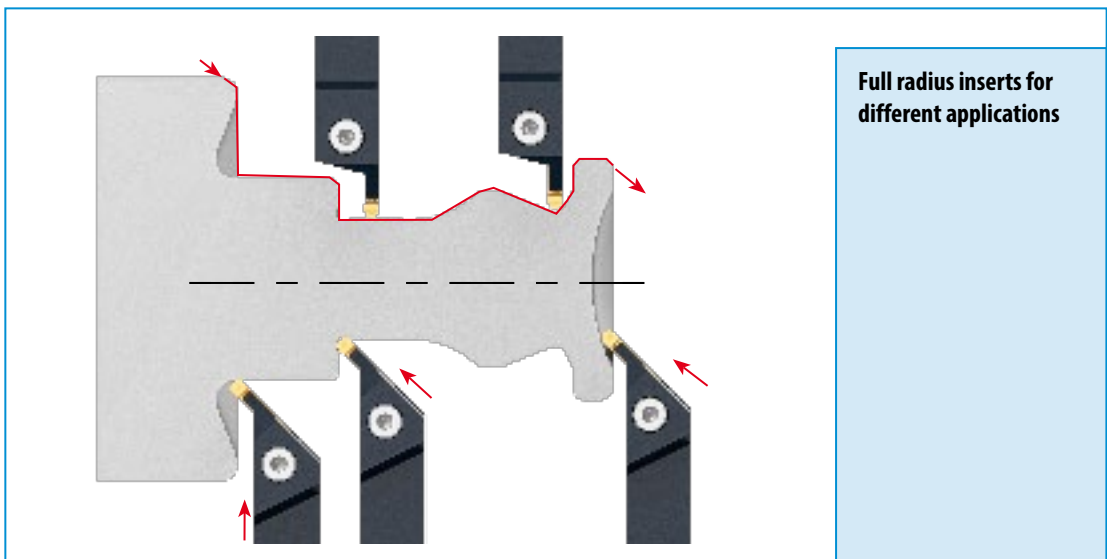

Full radius inserts for different applications

- Fitting tools
- Internal cooling p. 135, 137
 - Tech. Section p. 229
 - pocket size p. 230
 - Intersection (main cutting edge) p. 232
 - p. 133-134
 - p. 135
 - p. 136
 - p. 137
 - p. 137
 - p. 195

Radius and copying inserts

P92 P OTX R...N

System P92-P

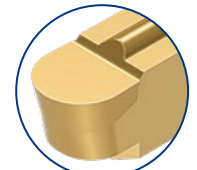
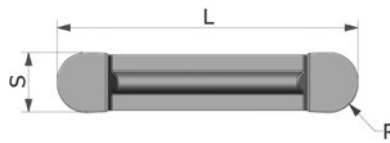
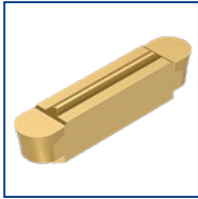

Enlarged view

WG260 Ref.	KM ID-Nr.	PM NANOSPEED ID-Nr.	pocket size	⌀	L ^{-0,1}	R	S ^{-0,20}
OTX 4 R 200N	11158	11159	P40	R + L	19,2	2,00	4,00
OTX 5 R 250N	11178	11179	P50	R + L	23,6	2,50	5,00
OTX 6 R 325N	11196	11197	P50	R + L	23,6	3,25	6,50

Superfinishing

Precision ground full radius inserts with 5° positive top rake angle.

Fitting tools. see below

P92 P OTX R...N R

System P92-P

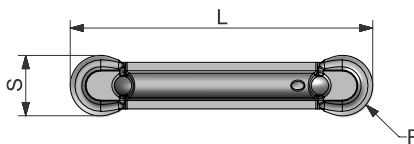
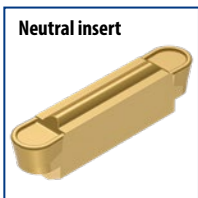

Enlarged view

WG260 Ref.	GF110 ID-Nr.	GF110 NANOSPEED ID-Nr.	pocket size	⌀	L ^{-0,1}	R	S ^{±0,025}
OTX 4 R 200N R	24266	24267	P40	R + L	20,0	2,00	4,00
OTX 5 R 250N R	24268	24269	P50	R + L	25,0	2,50	5,00

Finishing

Precision ground full radius insert. Horizontal cutting edge with parallel chip breaker. Especially recommended for heat resistant alloys.

Fitting tools

 Internal cooling p. 135, 137	 Tech. Section p. 229	 pocket size p. 230	 Intersection (main cutting edge) p. 232	 p. 133-134	 p. 135	 p. 136	 p. 137	 p. 137	 p. 195
--	--	--	---	---	---	---	---	---	---

Inserts for grooving and copying

STV R/L
System P92

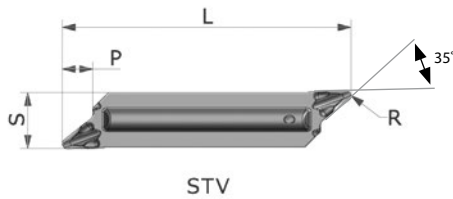

Enlarged view

WG301 Ref.	KM ID-Nr.	KM Aluspeed ID-Nr.	KM HYPERSPEED ID-Nr.	KM TILOX ID-Nr.	pocket size	()	L	Ls	R	P	S
STVL 5005	45154	57135	57136	57137	P50	L	25,0	2,5	0,05	2,50	5,00
STVL 501	45034	45018	45026	45121	P50	L	25,0	2,5	0,1	2,50	5,00
STVL 502	45035	45019	45027	45122	P50	L	25,0	2,5	0,2	2,50	5,00
STVL 503	56596	57138	57139	57140	P50	L	25,0	2,5	0,3	2,50	5,00
STVL 504	56598	57141	57142	53648	P50	L	25,0	2,5	0,4	2,50	5,00
STVR 5005	45153	57143	57144	57145	P50	R	25,0	2,5	0,05	2,50	5,00
STVR 501	45038	45022	45030	45123	P50	R	25,0	2,5	0,1	2,50	5,00
STVR 502	45039	45023	45031	45124	P50	R	25,0	2,5	0,2	2,50	5,00
STVR 503	56599	57146	57147	57148	P50	R	25,0	2,5	0,3	2,50	5,00
STVR 504	56601	57149	57150	54041	P50	R	25,0	2,5	0,4	2,50	5,00

Comment: STV R/L has been developed, to machine materials, which are difficult to cut, like:

- nonferrous heavy metals
- composite materials
- nickel alloys
- aluminium alloys
- plastic materials

STVL/R = polished surfaces, sharp cutting edges

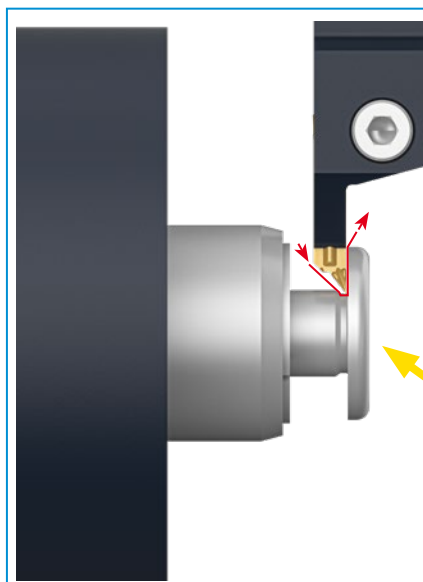

Recommended application of STV R/L, copying insert

Longitudinal turning, semi finishing and finishing

Semi finishing and finishing face cuts

Clearance cuts for threads and others

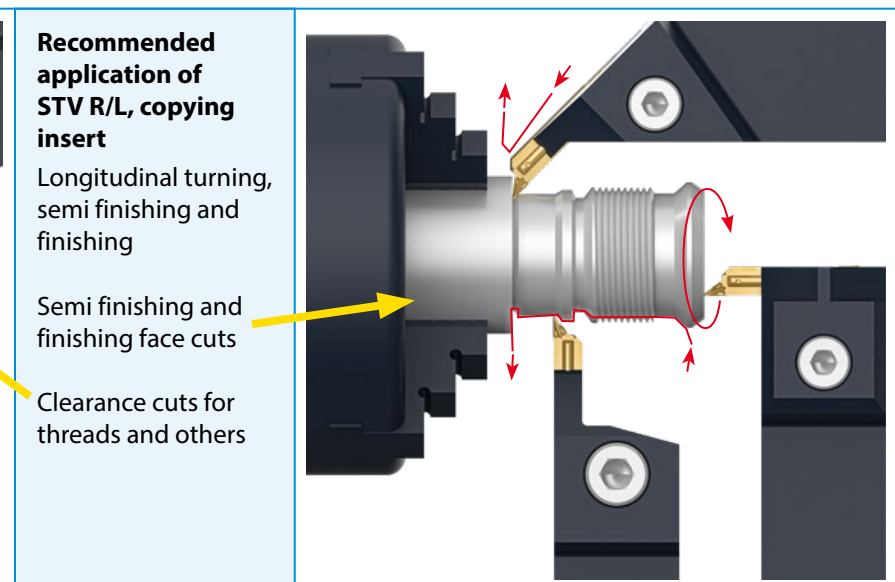

Fitting tools

- 

Internal cooling
p. 135, 137
- 

Tech. Section
p. 229
- 

pocket size
p. 230
- 

Intersection (main cutting edge)
p. 232
- 

p. 133-134
- 

p. 135
- 

p. 136
- 

p. 137
- 

p. 195

Inserts for profiling and copying

STD R/L
System P92 P

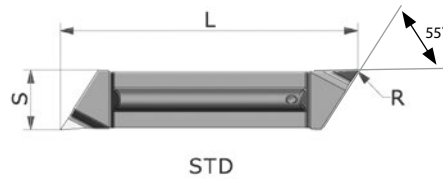
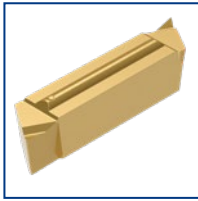

Enlarged view

WG301 Ref.	GF110 Nanospeed ID-Nr.	GF110 Hardspeed ID-Nr.	pocket size	(C)	L	R	S
STDL 5005	57158	57166	P50	L	24,6	0,05	5,00
STDL 501	57159	57167	P50	L	24,7	0,1	5,00
STDL 502	57160	57168	P50	L	24,7	0,2	5,00
STDR 5005	57162	57170	P50	R	24,6	0,05	5,00
STDR 501	57163	57171	P50	R	24,7	0,1	5,00
STDR 502	57164	57172	P50	R	24,7	0,2	5,00

Comment: STD R/L has been developed, to machine materials, which are difficult to cut, like:

- nonferrous heavy metals
- composite materials
- nickel alloys
- aluminum alloys
- plastic materials

STDL/R = polished surfaces, sharp cutting edges

Recommended application of STD R/L, copying insert

Longitudinal turning, semi finishing and finishing

Semi finishing and finishing face cuts

Clearance cuts for threads and others

- Fitting tools**
- p. 135, 137
 - p. 229
 - p. 230
 - p. 232
 - p. 133-134
 - p. 135
 - p. 136
 - p. 137
 - p. 195

Decolletage turning insert for sliding-head machine tools

P92 P OTX4

System P92-P

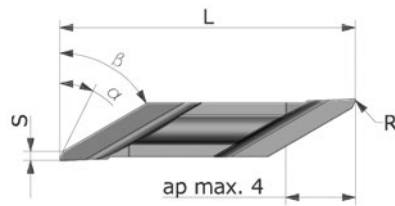
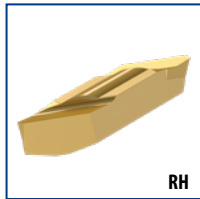

Enlarged view

WG260 Ref.	KM ID-Nr.	PM NANOSPEED ID-Nr.	pocket size	⌀	S	R	α°	β°
OTX 4 DECO SL0660 L01	24291	24301	P40	L	0,6	0,1	15	60
OTX 4 DECO SL1260 L01	24292	24304	P40	L	1,2	0,1	15	60
OTX 4 DECO SL0660 R01	24289	24295	P40	R	0,6	0,1	15	60
OTX 4 DECO SL1260 R01	24290	24298	P40	R	1,2	0,1	15	60
OTX 4 DECO SL0660 L02	11118	11119	P40	L	0,6	0,2	15	60
OTX 4 DECO SL1260 L02	11122	11123	P40	L	1,2	0,2	15	60
OTX 4 DECO SL0660 R02	11120	11121	P40	R	0,6	0,2	15	60
OTX 4 DECO SL1260 R02	11124	11125	P40	R	1,2	0,2	15	60

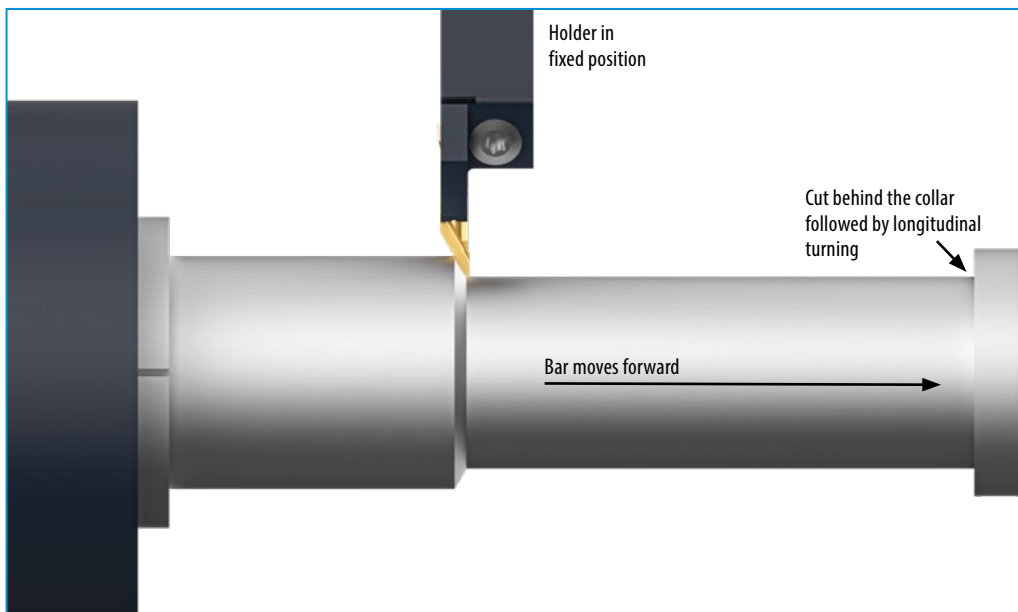

Precision ground DECO-insert:

- cuts easily
- runs quietly
- makes clean faces
- achieves long tool life



- Fitting tools**
- Internal cooling: p. 135, 137
 - Tech. Section: p. 229
 - pocket size: p. 230
 - Intersection (main cutting edge): p. 232
 - p. 133-134
 - p. 135
 - p. 136
 - p. 195

Threading inserts for ISO full profile

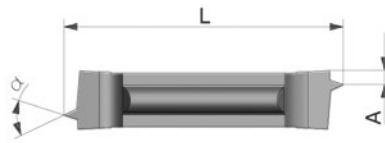
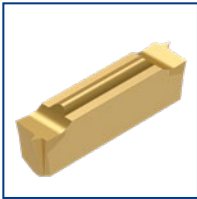
P92 P OTX ER
External thread
System P92-P



Enlarged view



WG260 Ref.	PM NANOSPEED ID-Nr.	pocket size		A	L ^{-0,1}	
OTX 4 ER ISO 100	11128	P40	1,00	0,8	19,20	60
OTX 4 ER ISO 125	11129	P40	1,25	0,8	19,20	60
OTX 4 ER ISO 150	11130	P40	1,50	1,0	19,20	60
OTX 4 ER ISO 175	11131	P40	1,75	1,1	19,20	60
OTX 4 ER ISO 200	11132	P40	2,00	1,4	19,20	60
OTX 4 ER ISO 250	11133	P40	2,50	1,5	19,20	60
OTX 4 ER ISO 300	11134	P40	3,00	1,8	19,20	60
OTX 4 ER 14 W	18235	P40	14 G/Zoll	1,3	19,20	55
OTX 4 ER 11 W	18242	P40	11 G/Zoll	1,5	19,20	55

Fitting tools, see below

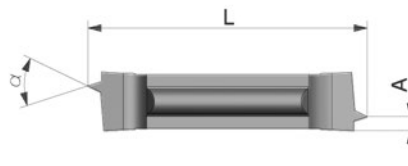
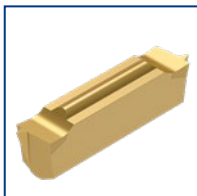







P92 P OTX IR
Internal thread
System P92-P



Enlarged view

WG260 Ref.	PM NANOSPEED ID-Nr.	pocket size		A	L - 0,1	
OTX 4 IR ISO 100	11135	P40	1,00	0,8	19,20	60
OTX 4 IR ISO 125	11136	P40	1,25	0,8	19,20	60
OTX 4 IR ISO 150	11137	P40	1,50	1,0	19,20	60
OTX 4 IR ISO 175	11138	P40	1,75	1,1	19,20	60
OTX 4 IR ISO 200	11139	P40	2,00	1,4	19,20	60
OTX 4 IR ISO 250	11140	P40	2,50	1,5	19,20	60
OTX 4 IR ISO 300	11141	P40	3,00	1,8	19,20	60
OTX 4 IR 11 W	44519	P40	11 G/Zoll	1,5	19,20	55
OTX 4 IR 14 W	31362	P40	14 G/Zoll	1,3	19,20	55
OTX 4 IR 19 W	31365	P40	19 G/Zoll	0,8	19,20	55

Fitting tools

 Internal cooling p. 135, 137	 Tech. Section p. 229	 pocket size p. 230	 Intersection (main cutting edge) p. 232	 p. 133-134	 p. 135	 p. 136	 p. 195
--	--	---	---	---	---	---	---

Part-profile threading inserts internal and external

P92 P OTX EIR

System P92-P

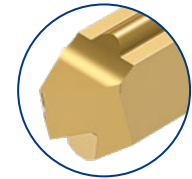
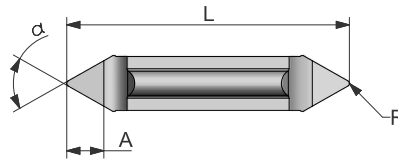
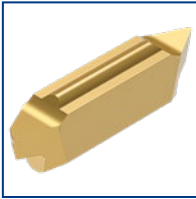

Enlarged view

WG260 Ref.	PM NANOSPEED ID-Nr.	pocket size		A	L - 0,1	R	α°
OTX 4 EIR 55 28 W	11126	P40	28 - 20 G/Zoll	2,7	19,20	0,10	55
OTX 4 EIR 60 050	11127	P40	0,5 - 1,00	2,7	19,20	0,10	60
OTX 4 EIR 55 19 W	24272	P40	19 - 14 G/Zoll	2,7	19,20	0,20	55
OTX 4 EIR 60 125	24278	P40	1,25 - 1,75	2,7	19,20	0,20	60
OTX 4 EIR 55 12 W	24275	P40	12 - 10 G/Zoll	2,7	19,20	0,30	55
OTX 4 EIR 60 200	24281	P40	2,00 - 3,00	2,7	19,20	0,30	60

6

CCW run

CCW run

OTX...EIR... for internal and external threading.

- Fitting tools**
- p. 229
 - p. 230
 - p. 232
 - p. 133-134
 - p. 135
 - p. 136
 - p. 195

Precision holders

P92 P CXCBL
System P92-P

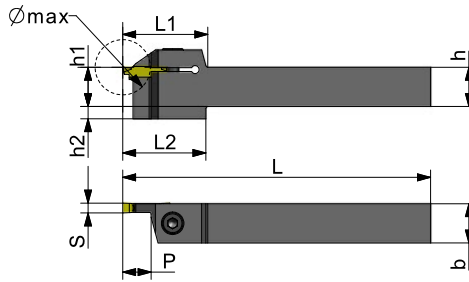
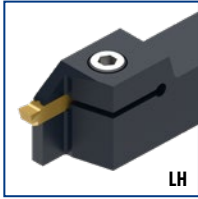

P92 P CXCBR
System P92-P

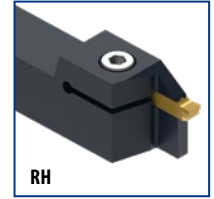

WG380 Ref.	ID-Nr.	pocket size	(C)	h	h1	h2	b	b1	P	S	L	L1	L2	
P92 P CXCBL 0808 K4	10168	P40	L	08	08	4	08	12	11	4	125	19,5	19,5	10
P92 P CXCBL 1616 K4	28169	P40	L	16	16	-	16	-	11	4	125	34,0	-	1
P92 P CXCBL 2020 K4	10178	P40	L	20	20	-	20	-	11	4	125	34,0	-	14
P92 P CXCBL 2525 M4	10182	P40	L	25	25	-	25	-	11	4	150	34,0	-	2
P92 P CXCBL 1616 K5+6	24257	P50	L	16	16	-	16	-	14	5+6,5	125	35,0	-	1
P92 P CXCBL 2020 K5+6	10180	P50	L	20	20	-	20	-	14	5+6,5	125	35,0	-	14
P92 P CXCBL 2525 M5+6	10184	P50	L	25	25	-	25	-	14	5+6,5	150	37,0	-	2
P92 P CXCBR 0808 K4	10167	P40	R	08	08	4	08	12	11	4	125	19,5	19,5	10
P92 P CXCBR 1616 K4	28168	P40	R	16	16	-	16	-	11	4	125	34,0	-	1
P92 P CXCBR 2020 K4	10177	P40	R	20	20	-	20	-	11	4	125	34,0	-	14
P92 P CXCBR 2525 M4	10181	P40	R	25	25	-	25	-	11	4	150	34,0	-	2
P92 P CXCBR 1616 K5+6	24256	P50	R	16	16	-	16	-	14	5+6,5	125	35,0	-	1
P92 P CXCBR 2020 K5+6	10179	P50	R	20	20	-	20	-	14	5+6,5	125	35,0	-	14
P92 P CXCBR 2525 M5+6	10183	P50	R	25	25	-	25	-	14	5+6,5	150	37,0	-	2

How to write an order: **recommended**

1 pc. P92 P 90 CXCBRL 1620 K5+6 UNI or: **1 pc. ID-Nr. 24885**

10 pcs. OTX5 R 250N R GF110 NANOSPEED or: **10 pcs. ID-Nr. 24269**

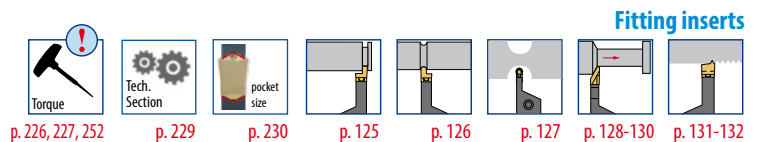

Precision tool holders for sliding head machine tools

P92 P CXCBL..K4-11

System P92-P

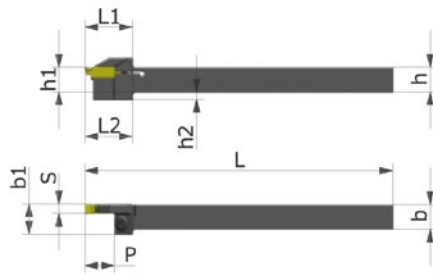
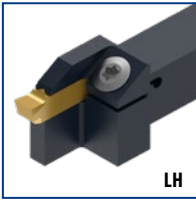

P92 P CXCBR..K4-11

System P92-P

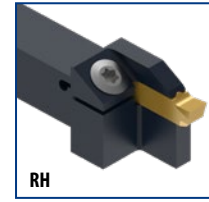

WG380 Ref.	ID-Nr.	pocket size	↺	h	h1	h2	b	b1	P	S	L	L1	L2	
P92 P CXCBL 1010 K4 11	15617	P40	L	10	10	3	10	12	11	4	125	19,5	19,5	9
P92 P CXCBL 1212 K4 11	14374	P40	L	12	12	-	12	-	11	4	125	-	19,5	4
P92 P CXCBL 1616 K4 11	24259	P40	L	16	16	-	16	-	11	4	125	-	19,5	4
P92 P CXCBR 1010 K4 11	15618	P40	R	10	10	3	10	12	11	4	125	19,5	19,5	9
P92 P CXCBR 1212 K4 11	18705	P40	R	12	12	-	12	-	11	4	125	-	19,5	4
P92 P CXCBR 1616 K4 11	24258	P40	R	16	16	-	16	-	11	4	125	-	19,5	4

6

Precision radius

Precision turning

Precision grooving

Precision threading

GripLock precision inserts on sliding head machines

- Short extension
- Easy fixing
- Many applications
- Tailor made inserts available

Fitting inserts

Torque

p. 226, 227, 252

Tech Section

p. 229

pocket size

p. 230

p. 125

p. 126

p. 127

p. 128-130

p. 131-132

Precision boring bars with internal cooling

P92 P CGL
System P92-P

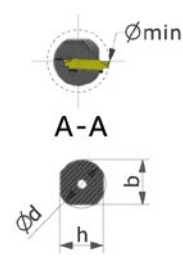
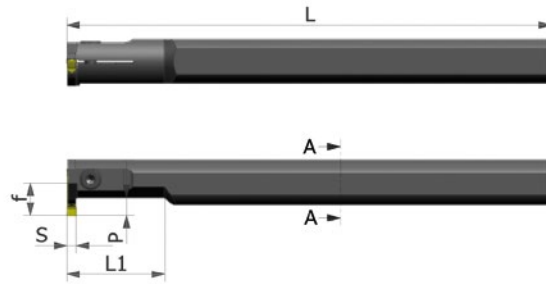

P92 P CGR
System P92-P



WG390 Ref.	ID-Nr.	pocket size	()	Ømin	d	h	b	f	P	S	L	L1	
P92 P CGL 0020 R4	10156	P40	L	24	20	18	18,5	13	7	4,0	200	40	6
P92 P CGL 0025 R4	10160	P40	L	32	25	23	23,0	17	10	4,0	200	50	14
P92 P CGL 0032 S4	10164	P40	L	42	32	30	30,0	22	12	4,0	250	64	14
P92 P CGL 0020 R5+6	10158	P50	L	27	20	18	18,5	15	9	5+6,5	200	40	6
P92 P CGL 0025 R5+6	10162	P50	L	32	25	23	23,0	17	10	5+6,5	200	50	14
P92 P CGL 0032 S5+6	10166	P50	L	44	32	30	30,0	26	16	5+6,5	250	64	14
P92 P CGL 0040 T5+6	33468	P50	L	52	40	38	38,0	30	16	5+6,5	300	80	2
P92 P CGR 0020 R4	10155	P40	R	24	20	18	18,5	13	7	4,0	200	40	6
P92 P CGR 0025 R4	10159	P40	R	32	25	23	23,0	17	10	4,0	200	50	14
P92 P CGR 0032 S4	10163	P40	R	42	32	30	30,0	22	12	4,0	250	64	14
P92 P CGR 0020 R5+6	10157	P50	R	27	20	18	18,5	15	9	5+6,5	200	40	6
P92 P CGR 0025 R5+6	10161	P50	R	32	25	23	23,0	17	10	5+6,5	200	50	14
P92 P CGR 0032 S5+6	10165	P50	R	44	32	30	30,0	26	16	5+6,5	250	64	14
P92 P CGR 0040 T5+6	24445	P50	R	52	40	38	38,0	30	16	5+6,5	300	80	2

How to write an order:

1 pc. P92 P CGR 0020 R4 or: **1 pc. ID-Nr. 10155** recommended

10 pcs. OTX4 IR ISO 100 PM NANOSPEED or: **10 pcs. ID-Nr. 11135**

Attention!

LH inserts and RH boring bars fit together.
RH inserts and LH boring bars fit together.

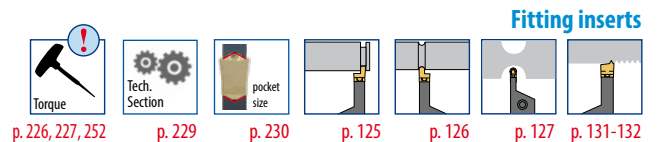

90° - Holders for many different turning applications

P92 P 90 UNI

System P92-P und P92

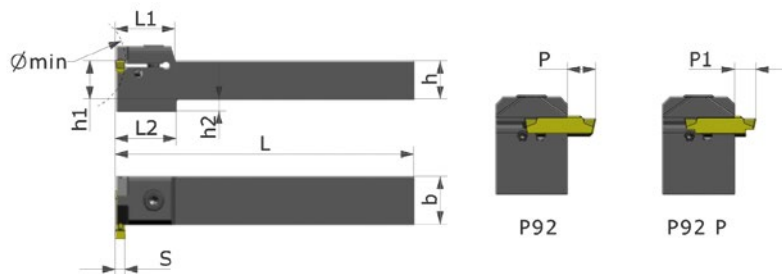
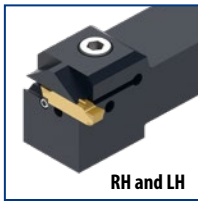

WG380 Ref.	ID-Nr.	pocket size	(C)	h	h1	h2	b	P	P1	S	L	L1	L2	
P92 P 90 CXCBRL 1620 K4 UNI	24694	P40	R + L	16	16	5	20	7,5	5,0	4	125	25	23	1+13
P92 P 90 CXCBRL 2020 K4 UNI	10185	P40	R + L	20	20	-	20	7,5	5,0	4	125	25	-	1+13
P92 P 90 CXCBRL 2525 M4 UNI	10187	P40	R + L	25	25	-	25	7,5	5,0	4	150	25	-	1+13
P92 P 90 CXCBRL 1620 K5+6 UNI	24885	P50	R + L	16	16	5	20	9,5	6,0	5 + 6,5	125	25	23	1+13
P92 P 90 CXCBRL 2020 K5+6 UNI	10186	P50	R + L	20	20	-	20	9,5	6,0	5 + 6,5	125	25	-	1+13
P92 P 90 CXCBRL 2525 M5+6 UNI	10188	P50	R + L	25	25	-	25	9,5	6,0	5 + 6,5	150	34	-	1+13

6

Smallest face grooving diameter for P92 or P92 P inserts.
(Special inserts for smaller diameters by request)

Groove clearance cut and face grooving

Threading and radius face grooving

2 tapped holes for a positioning pin permit the use of P92 and P92-P inserts for CW and CCW run!

P92 P92 P

Stopping face P92 P

Stopping face P92

Tapped holes for one pin

Fitting inserts P92
(please pay attention to dimension P1)

p. 61 - 70 p. 71 p. 74-80 p. 83-86

p. 226, 227, 252 p. 229 p. 230

Fitting inserts P92 P
(please pay attention to dimension P1)

p. 125 p. 126 p. 127 p. 128-130

Holders for relieve grooves and copy turning

P92 P 45 CXCBL
System P92-P

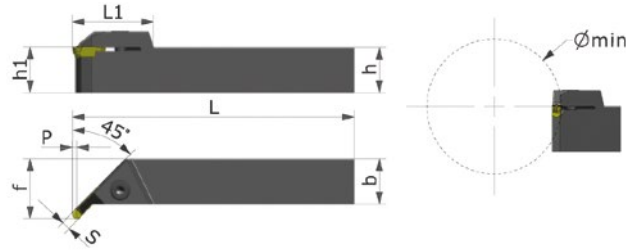
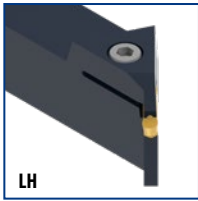

P92 P 45 CXCBR
System P92-P

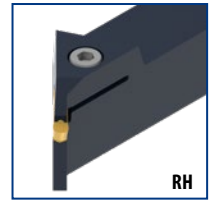

WG380 Ref.	ID-Nr.	pocket size	(C)	Ømin	h	h1	b	f	Pmax	S	L	L1	
P92 P 45 CXCBL 1616 K4	19747	P40	L	>25	16	16	16	22	1,5	4	125	35	1
P92 P 45 CXCBL 2020 K4	19664	P40	L	>25	20	20	20	26	1,5	4	125	35	5
P92 P 45 CXCBL 2525 M4	19755	P40	L	>25	25	25	25	31	1,5	4	150	39	5
P92 P 45 CXCBL 1620 K5+6	19749	P50	L	>40	16	16	20	26	2,0	5+6,5	125	35	1
P92 P 45 CXCBL 2020 K5+6	19751	P50	L	>40	20	20	20	26	2,0	5+6,5	125	37	5
P92 P 45 CXCBL 2525 M5+6	19752	P50	L	>40	25	25	25	31	2,0	5+6,5	150	39	5
P92 P 45 CXCBR 1616 K4	19746	P40	R	>25	16	16	16	22	1,5	4	125	35	1
P92 P 45 CXCBR 2020 K4	19663	P40	R	>25	20	20	20	26	1,5	4	125	35	5
P92 P 45 CXCBR 2525 M4	19754	P40	R	>25	25	25	25	31	1,5	4	150	39	5
P92 P 45 CXCBR 1620 K5+6	19748	P50	R	>40	16	16	20	26	2,0	5+6,5	125	35	1
P92 P 45 CXCBR 2020 K5+6	19750	P50	R	>40	20	20	20	26	2,0	5+6,5	125	37	5
P92 P 45 CXCBR 2525 M5+6	19753	P50	R	>40	25	25	25	31	2,0	5+6,5	150	39	5

Attention!

LH inserts and RH boring bars fit together.
RH inserts and LH boring bars fit together.



Fitting inserts, see below

Boring bars with internal cooling for relieve grooves

P92 P 45 CGL
System P92-P

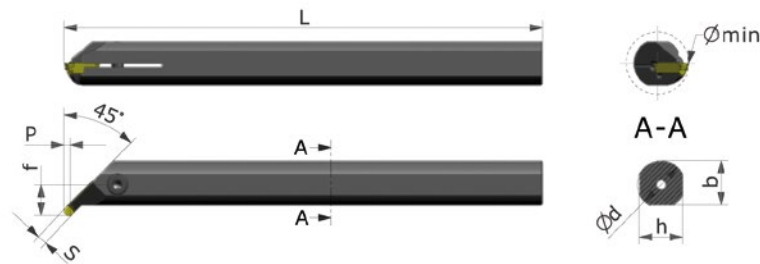

P92 P 45 CGR
System P92-P



WG390 Ref.	ID-Nr.	pocket size	(C)	Ømin	h	b	f	Pmax.	S	L	
P92 P 45 CGL 0020 R4	19660	P40	L	25	18	18,5	13	1,5	4	200	6
P92 P 45 CGL 0025 R4	19662	P40	L	28	23	23	15,5	1,5	4	200	1
P92 P 45 CGR 0020 R4	19659	P40	R	25	18	18,5	13	1,5	4	200	6
P92 P 45 CGR 0025 R4	19661	P40	R	28	23	23	15,5	1,5	4	200	1

Fitting inserts



p. 226, 227, 252



p. 229



p. 230

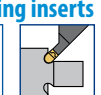

p. 127

Precision grooving inserts according to DIN 472

P92 P KOTX L

System P92-P

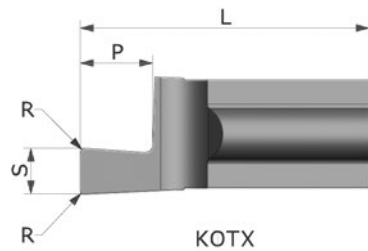
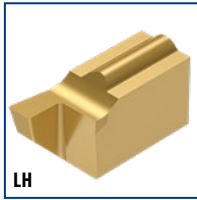

KOTX



KOTX...L



KOTX...R

P92 P KOTX R

System P92-P

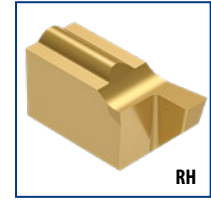

RH

WG260 Ref.	PM NANOSPEED ID-Nr.	pocket size	(C)	L ^{-0,1}	P	R		S ^{-0,05}
KOTX4 090L	10918	PK40	L	9,2	1,5	0,1	0,90	0,97
KOTX4 110L	10922	PK40	L	9,2	1,5	0,1	1,10	1,24
KOTX4 130L	10926	PK40	L	9,2	1,5	0,1	1,30	1,44
KOTX4 160L	10930	PK40	L	9,2	2,0	0,1	1,60	1,74
KOTX4 185L	10934	PK40	L	9,2	2,0	0,1	1,85	1,99
KOTX4 215L	10938	PK40	L	9,2	2,5	0,1	2,15	2,29
KOTX4 265L	10942	PK40	L	9,2	2,5	0,1	2,65	2,79
KOTX4 315L	10950	PK40	L	9,2	2,5	0,1	3,15	3,29
KOTX4 090R	10917	PK40	R	9,2	1,5	0,1	0,90	0,97
KOTX4 110R	10921	PK40	R	9,2	1,5	0,1	1,10	1,24
KOTX4 130R	10925	PK40	R	9,2	1,5	0,1	1,30	1,44
KOTX4 160R	10929	PK40	R	9,2	2,0	0,1	1,60	1,74
KOTX4 185R	10933	PK40	R	9,2	2,0	0,1	1,85	1,99
KOTX4 215R	10937	PK40	R	9,2	2,5	0,1	2,15	2,29
KOTX4 265R	10941	PK40	R	9,2	2,5	0,1	2,65	2,79
KOTX4 315R	10949	PK40	R	9,2	2,5	0,1	3,15	3,29

Fitting tools, see below

P92 P KOTX R..L

System P92-P

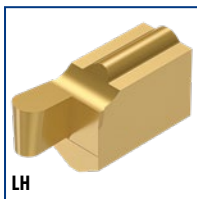

LH

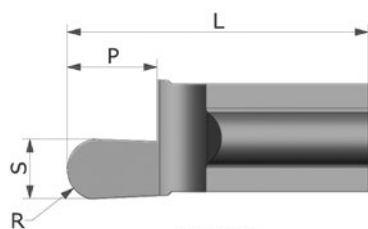

KOTX4R



KOTX4R..L



KOTX4R..R

P92 P KOTX R..R

System P92-P

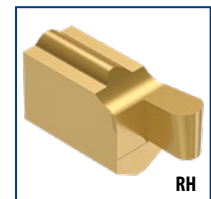

RH

WG260 Ref.	PM NANOSPEED ID-Nr.	pocket size	(C)	L ^{-0,1}	P	R		S ^{+0,05}
KOTX4 R 100L	10961	PK40	L	9,2	2,5	1,00		2,00
KOTX4 R 150L	10965	PK40	L	9,2	2,5	1,50		3,00
KOTX4 R 100R	10960	PK40	R	9,2	2,5	1,00		2,00
KOTX4 R 150R	10964	PK40	R	9,2	2,5	1,50		3,00

Fitting tools



p. 139



p. 229



p. 230



p. 232



p. 139

Full profile inserts for internal and external threading

P92 P KOTX IR

System P92-P

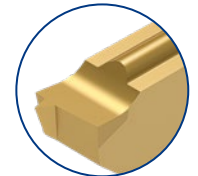
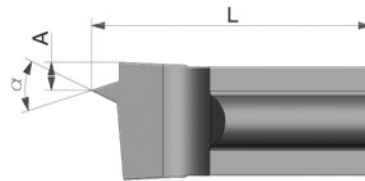
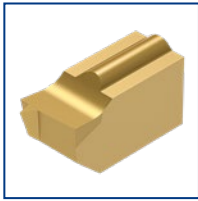

Enlarged view

WG260 Ref.	PM NANOSPEED ID-Nr.	pocket size		A	L ±0,1	α°
KOTX4 IR ISO 100	10951	PK40	1,00	0,8	9,20	60
KOTX4 IR ISO 125	10952	PK40	1,25	0,8	9,20	60
KOTX4 IR ISO 150	10953	PK40	1,50	1,0	9,20	60
KOTX4 IR ISO 175	10954	PK40	1,75	1,1	9,20	60
KOTX4 IR ISO 200	10955	PK40	2,00	1,4	9,20	60
KOTX4 IR ISO 250	10956	PK40	2,50	1,5	9,20	60
KOTX4 IR ISO 300	10957	PK40	3,00	1,8	9,20	60

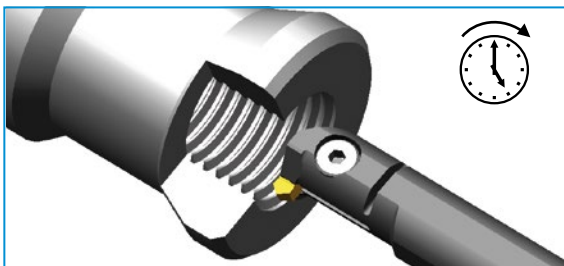

Internal threading with KOTX IR ISO ...

Fitting tools

- p. 229
- p. 230
- p. 232
- p. 139

Boring bars with internal cooling for grooving and threading

P92 P CGL 4C

System P92-P



LH

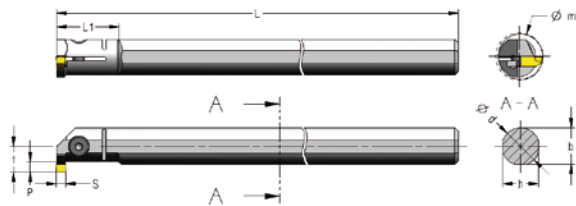

P92 P CGR 4C

System P92-P



RH

WG390 Ref.	ID-Nr.	pocket size	\odot	\emptyset min	d	h	b	f	p	S	L	L1	
P92 P CGL 0012 M4C	10152	PK40	L	15,5	12	11	-	8,7	2,5	max 1,85	150	22	22
P92 P CGL 0016 P4C	10154	PK40	L	20	16	15	15,5	11	2,5	max 3,15	170	26	19
P92 P CGR 0012 M4C	10151	PK40	R	15,5	12	11	-	8,7	2,5	max 1,85	150	22	22
P92 P CGR 0016 P4C	10153	PK40	R	20	16	15	15,5	11	2,5	max 3,15	170	26	19

Attention!

LH inserts and RH boring bars fit together.
RH inserts and LH boring bars fit together.

Fitting inserts

- p. 226, 227, 252
- p. 229
- p. 230
- p. 138-139

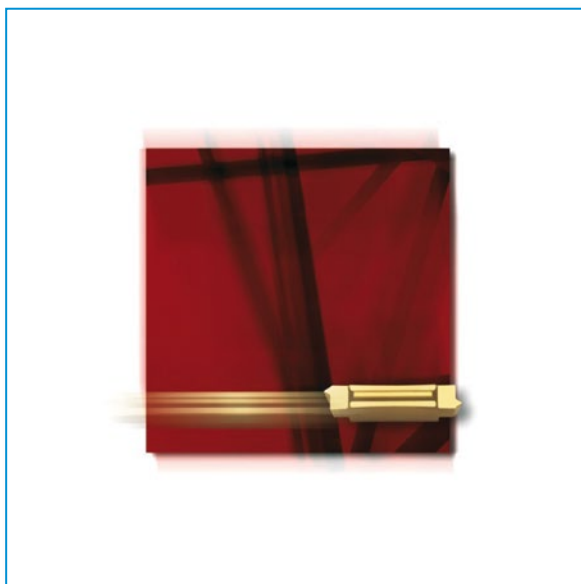
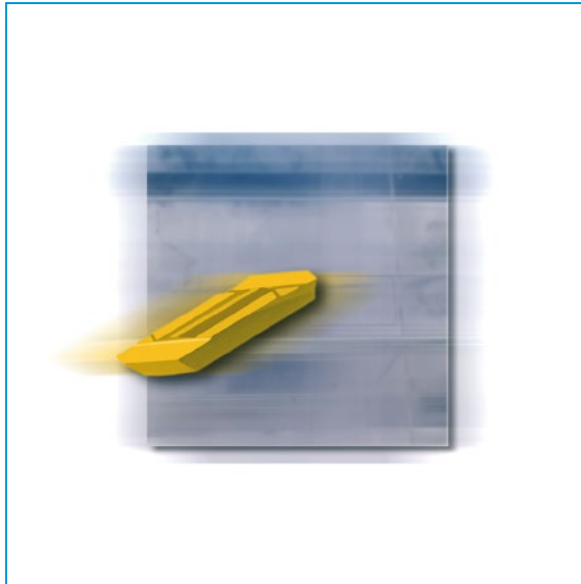

P92 S Grooving and parting off

*Cutting and turning, grooving
and parting off and threading
with twin-cut series (edge width 2 mm)*

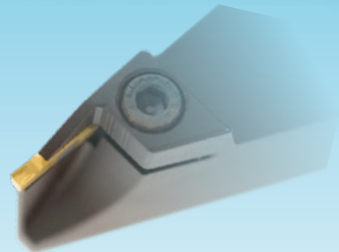

twin-cut
CHIP BREAKERS









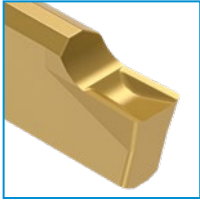

P92 S Grooving and parting off

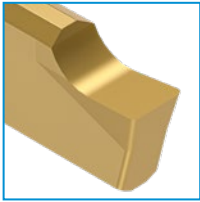
Cutting and turning, grooving and parting off and threading with twin-cut series (edge width 2 mm)

Chip breaker types *twin cut*

Grooving turning		<p>HTNST page 145</p>	 <p>HEUBERG-T</p>
---------------------	---	---------------------------	---

Parting off / grooving		<p>STN... page 144</p>	 <p>SUPERNOVA</p>
		<p>HTN... page 144</p>	 <p>HEUBERG</p>
		<p>BTN... page 143</p>	 <p>BT-CHIP BREAKER</p>
		<p>ITN... page 143</p>	 <p>IT-CHIP BREAKER</p>

7

Inserts with 2 edges for parting off and grooving

BTNS

System P92-S

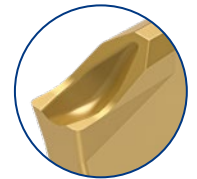
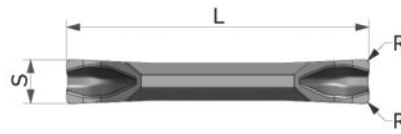
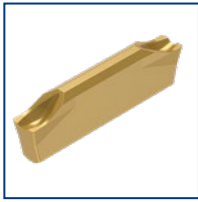

Enlarged view

WG300 Ref.	KM	PM NANOSPEED	KM TILOX	pocket size	()	L	R	S ±0,10	α°
	ID-Nr.	ID-Nr.	ID-Nr.						
BTNS 2	30501	30504	30502	S20	N	14,00	0,2	2,00	0

BTNS Parting off chip breaker

Grooved parting off edge with reinforced flanks. The deep and spacious **chip-trough** gives excellent chip control. Efficient on almost all materials.



p. 153



p. 229



p. 230



p. 232



p. 152



p. 153

Fitting tools

ITN S/R/L

System P92-S

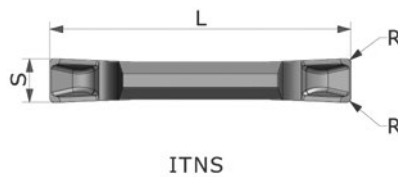

ITNS



ITNL



ITNR

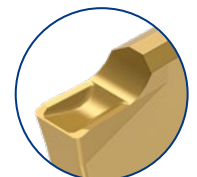

Enlarged view

WG300 Ref.	KM	PM NANOSPEED	KM TILOX	pocket size	()	L	R	S ±0,10	α°
	ID-Nr.	ID-Nr.	ID-Nr.						
ITNS 2	10534	10536	15172	S20	N	14,00	0,2	2,00	0
ITNL 2 8D	10529	10533	30508	S20	L	14,00	0,2	2,00	8
ITNR 2 8D	10528	10532	13801	S20	R	14,00	0,2	2,00	8

twiN-cut | Typ-IT

Horizontal, chamfered cutting edge with reinforced flanks and large chip chamber.

Especially recommended for:

- high alloy steels
- stainless steels
- interrupted cuts



p. 153



p. 229



p. 230



p. 232



p. 152



p. 153

Fitting tools

Inserts with 2 edges for parting off and grooving

STN S/R/L

System P92-S

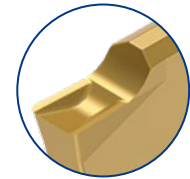
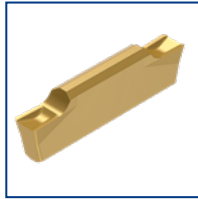

Enlarged view

WG300 Ref.	KM	PM NANOSPEED	PM TILOX	KM TILOX	pocket size	()	L	R	S ±0,10	α°
	ID-Nr.	ID-Nr.	ID-Nr.	ID-Nr.						
STNS 2	19587	11441	11440	26742	S20	N	14,00	0,2	2,00	0
STNL 2 10D	11434	11438	11436	-	S20	L	14,00	0,2	2,00	10
STNR 2 10D	11433	11437	11435	-	S20	R	14,00	0,2	2,00	10

twin-cut | Typ SUPERNOVA

The arc-shaped, slightly honed cutting edge with its large chip-chamber leads to good chip control. For universal use.

Fitting tools



p. 153



p. 229



p. 230



p. 232



p. 152



p. 153

7

HTN S/R/L

System P92-S

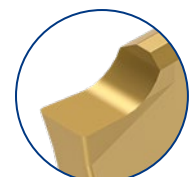
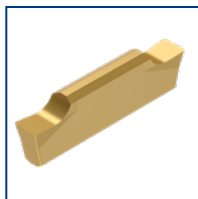

Enlarged view

WG300 Ref.	KM	PM NANOSPEED	PM TILOX	KM TILOX	pocket size	()	L	R	S ±0,10	α°
	ID-Nr.	ID-Nr.	ID-Nr.	ID-Nr.						
HTNS 2	10579	10581	10580	23647	S20	N	14,00	0,2	2,00	0
HTNSF 2	23648	23693	23690	-	S20	N	13,40	0,0	2,00	0
HTNL 2 6D	23660	23702	23698	-	S20	L	14,00	0,2	2,00	6
HTNLF 2 6D	23659	23703	23699	-	S20	L	13,40	0,0	2,00	6
HTNL 2 15D	10574	10578	10576	-	S20	L	14,00	0,2	2,00	15
HTNLF 2 15D	23659	23695	23692	-	S20	L	13,40	0,0	2,00	15
HTNR 2 6D	23654	23700	23696	-	S20	R	14,00	0,2	2,00	6
HTNRF 2 6D	23652	23701	23697	-	S20	R	13,40	0,0	2,00	6
HTNR 2 15D	10573	10577	10575	-	S20	R	14,00	0,2	2,00	15
HTNRF 2 15D	23651	23694	23691	-	S20	R	13,40	0,0	2,00	15

twin-cut | Typ: „Heuberg“

Horizontal ground cutting edge with positive top rake angle. Recommended for automatic lathe cutting jobs on free cutting materials.

Remark

Inserts marked with „F“ have ground cutting edges without corner radius, e.g. HTNSF

Fitting tools



p. 153



p. 229



p. 230



p. 232



p. 152



p. 153

Inserts with 2 edges for grooving and turning

HTNST
System P92-S

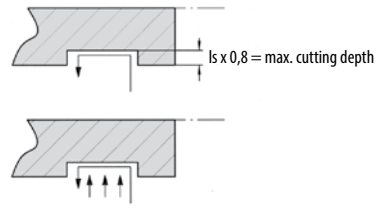
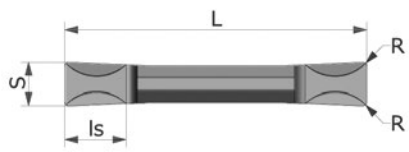
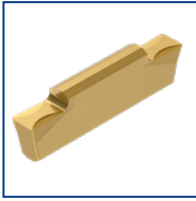

Enlarged view

WG300 Bezeichnung	KM	PM NANOSPEED	KM TILOX	Platten- sitzgröße	⌀	L	Is	R	S ±0,10	α°
	ID-Nr.	ID-Nr.	ID-Nr.							
HTNST 2	24058	24061	34314	S20	N	14,00	0,60	0,2	2,00	0





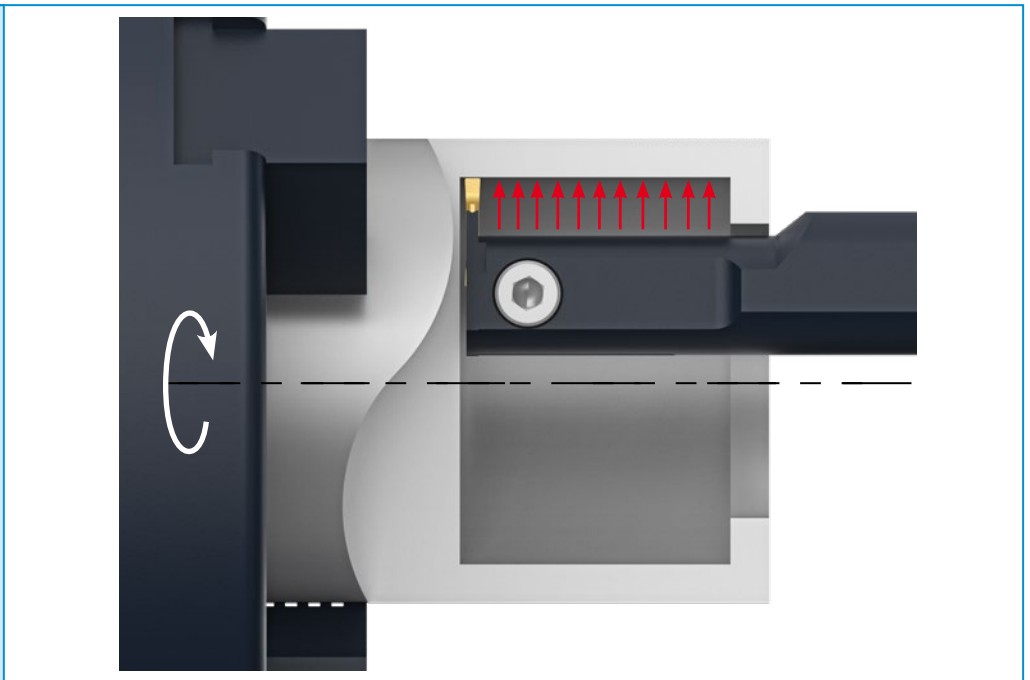

Cutting and turning insert

Horizontal major cutting edge with sharply ground minor turning edges.
Excellent chip control.

HTNST 2 KM TILOX
in action:
grooving a large
chamber with a
final finishing cut.



Fitting tools

 Internal cooling p. 153	 Tech. Section p. 229	 pocket size p. 230	 Intersection (main cutting edge) p. 232	 p. 152	 p. 153
--	--	--	---	---	---

External threading inserts for Whitworth and ISO Full profile

HTNG 2 ER
System P92-S

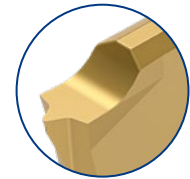
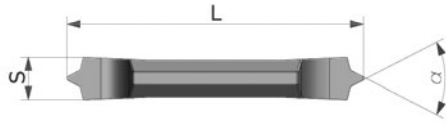
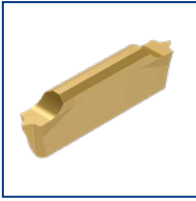

Enlarged view

WG260 Ref.	KM ID-Nr.	PM NANOSPEED ID-Nr.	pocket size		L ^{-0,1}	S	α°
HTNG 2 ER ISO 035	28436	38475	S20	0,35	13,8	2,00	60°
HTNG 2 ER ISO 050	10998	10999	S20	0,50	13,8	2,00	60°
HTNG 2 ER ISO 070	25925	31391	S20	0,70	13,8	2,00	60°
HTNG 2 ER ISO 075	11000	11001	S20	0,75	13,8	2,00	60°
HTNG 2 ER ISO 080	25927	30791	S20	0,80	13,8	2,00	60°
HTNG 2 ER ISO 100	11002	11003	S20	1,00	13,8	2,00	60°
HTNG 2 ER ISO 125	11004	11005	S20	1,25	13,8	2,00	60°
HTNG 2 ER ISO 150	11006	11007	S20	1,50	13,8	2,00	60°
HTNG 2 ER 14W	38474	29937	S20	14 G/Zoll	13,8	2,00	55°
HTNG 2 ER 19W	10994	10995	S20	19 G/Zoll	13,8	2,00	55°
HTNG 2 ER 28W	10996	10997	S20	28 G/Zoll	13,8	2,00	55°

Remark: These inserts can be used for RH and LH threading.

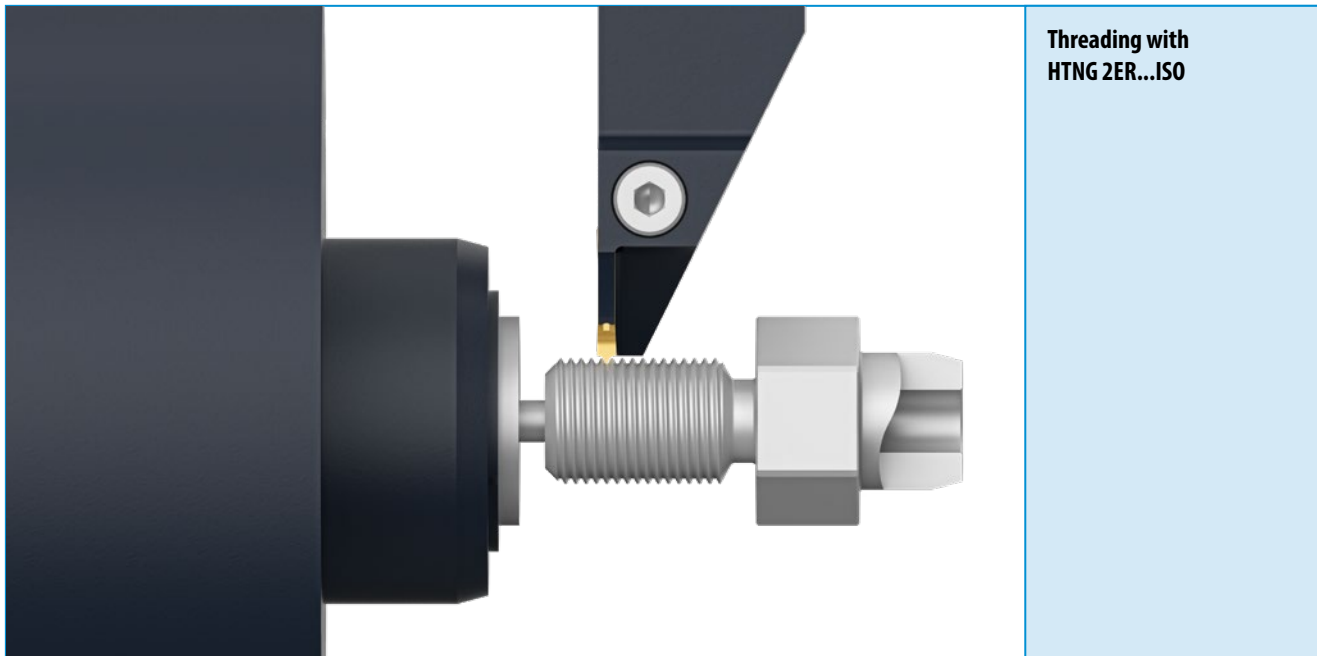

Fitting tools

- Internal cooling p. 153
- Tech. Section p. 229
- pocket size p. 230
- Intersection (main cutting edge) p. 232
- p. 152, 153



Internal threading inserts for Whitworth and ISO Full profile

HTNG 2 IR

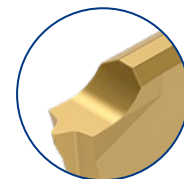
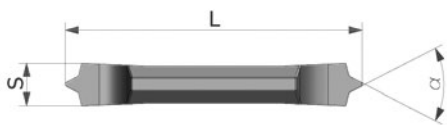
System P92-S



Enlarged view

WG260 Ref.	KM ID-Nr.	PM NANOSPEED ID-Nr.	pocket size		L-0,1	S	
HTNG 2 IR ISO 100	38498	38501	S20	1,00	13,8	2,00	60°
HTNG 2 IR ISO 150	38499	38502	S20	1,50	13,8	2,00	60°
HTNG 2 IR 14W	38500	38503	S20	14 G/inch	13,8	2,00	55°

Remark: These inserts can be used for RH and LH threading.

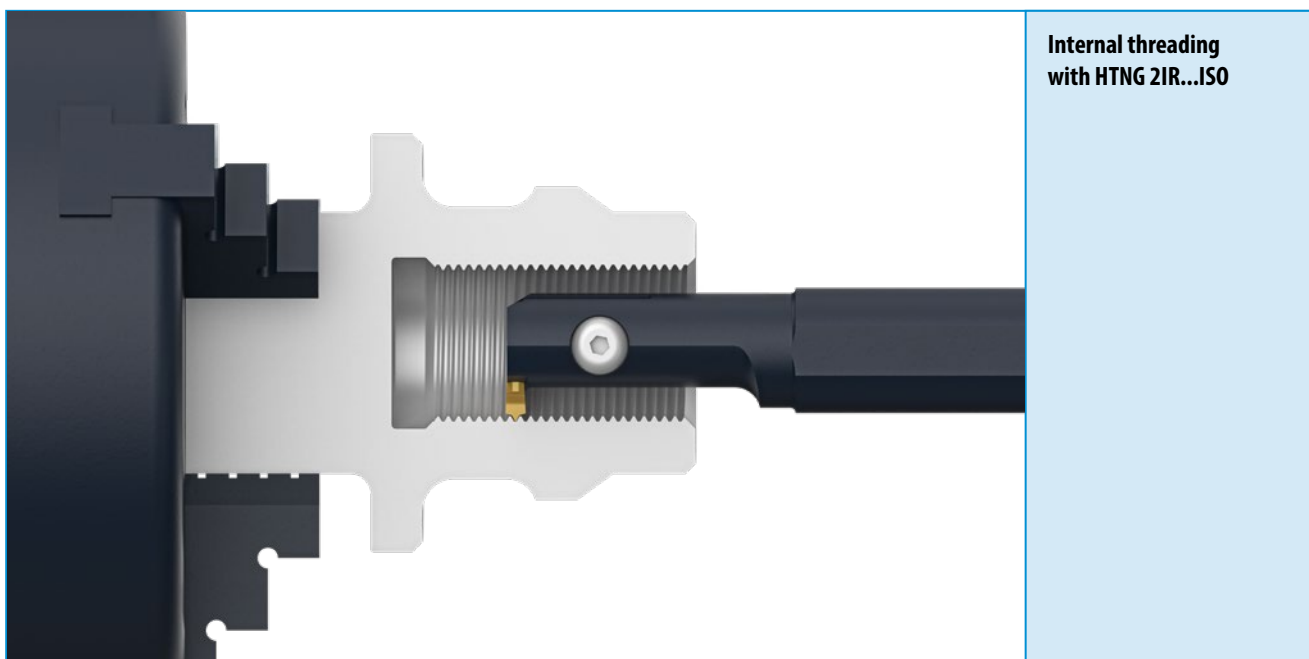

- Fitting tools**
- 
 Internal cooling
 p. 153
 - 
 Tech. Section
 p. 229
 - 
 pocket size
 p. 230
 - 
 Intersection (main cutting edge)
 p. 232
 - 
 p. 153

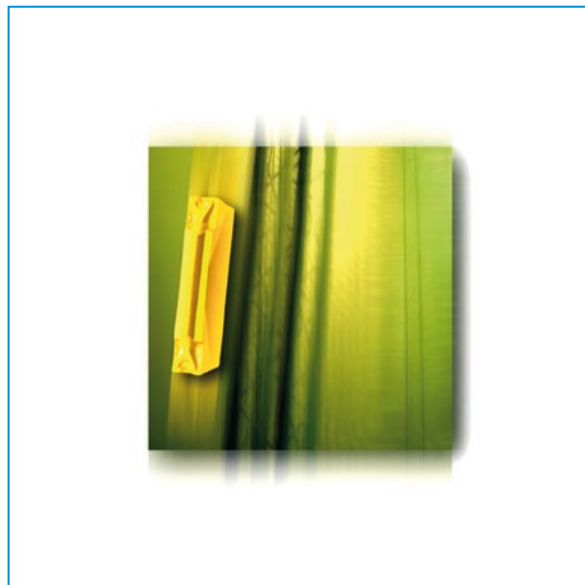

Hard material machining



*Inserts, coating and tool holders
for parting off, grooving and turning*

Inserts with efficient chip breakers and special coating HARDLOX 2[®] for:

- ▶ *hardened materials*
- ▶ *machining hardened materials*
- ▶ *exotic and tempered materials*

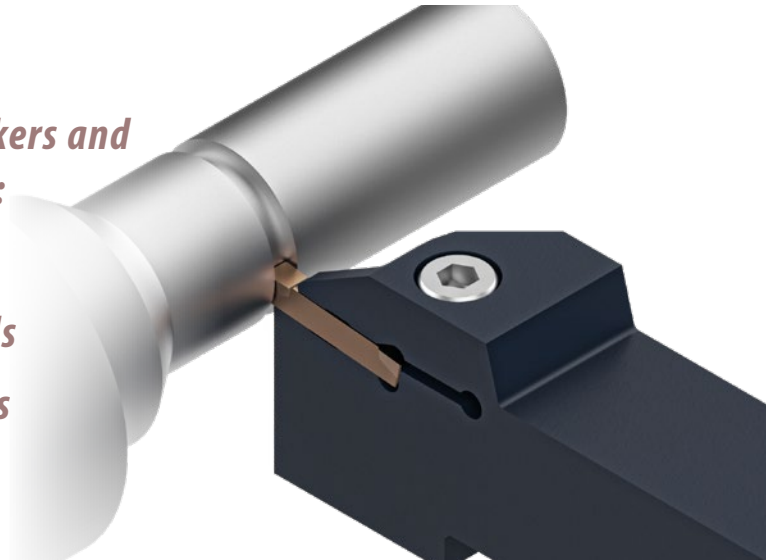

Machining materials with a Rockwell hardness of 54 and more. Inserts and holders are stressed heavily on such operations. Therefore starting-up speeds, feeds and depths should be low graded.

HARDLOX 2[®]



- Polished edges and surfaces
- Low price alternative compared with CBN tipped inserts
- To be used on unhardened steels as well
- Multi edge inserts available
- Constant performance when cutting from hard layer into soft core

Hardened layer

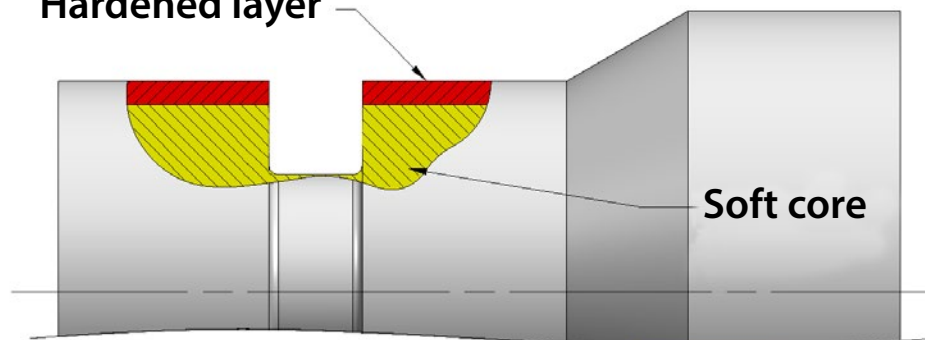

Remark: Other inserts with HARDLOX 2[®] on request.

Inserts for grooving and parting off | Hard material machining

ITNS

System P92 S

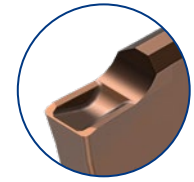
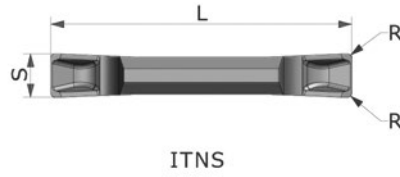
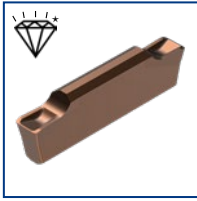

Enlarged view

WG302 Ref.	KM Hardlox2	pocket size		L	R	S ±0,10
	ID-Nr.					
ITNS 2	54909	S20	N	14,00	0,2	2,00

Remark: Inserts for internal and external machining

Fitting tools, see below

STNS

System P92 S

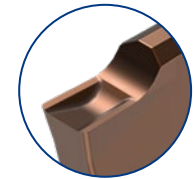
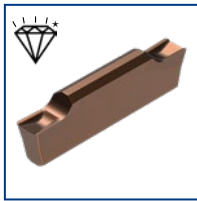

Enlarged view

WG302 Ref.	KM Hardlox2	pocket size		L	R	S ±0,10
	ID-Nr.					
STNS 2	54910	S20	N	14,00	0,2	2,00

Remark: Inserts for internal and external machining

Fitting tools, see below

HTNS

System P92 S

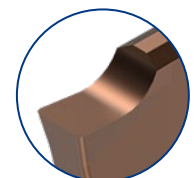
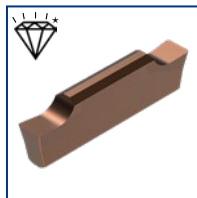

Enlarged view

WG302 Ref.	KM Hardlox2	pocket size		L	R	S ±0,10
	ID-Nr.					
HTNS 2	38767	S20	N	14,00	0,2	2,00

Remark: Inserts for internal and external machining

Fitting tools

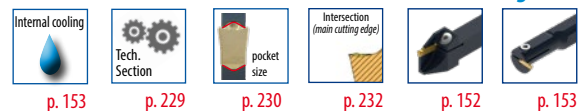

Inserts for grooving and parting off | Hard material machining

KHTNS

System P92 S

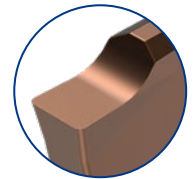
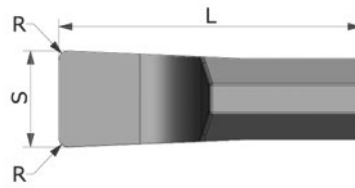
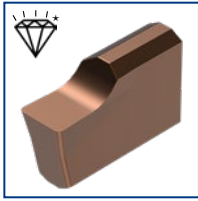

Enlarged view

WG302 Ref.	KM Hardlox2	pocket size	()	L ±0,1	R	S ±0,10
	ID-Nr.					
KHTNS 2	38770	SK20	N	6,35	0,2	2,0

Remark

Inserts for small diameters.

Fitting tools



p. 153



p. 229



p. 230



p. 232



p. 155

Holders for parting off and grooving

P92 S CXCBL

System P92-S

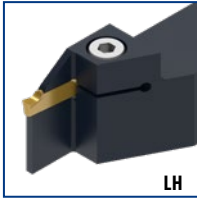

LH

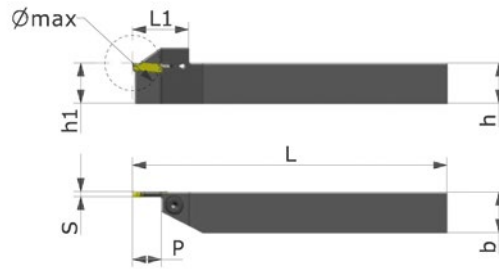

P92 S CXCBR

System P92-S

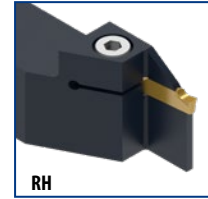

RH

WG380 Ref.	ID-Nr.	pocket size	↻	Ø max	h	h1	b	P	S	L	L1	
P92 S CXCBL 1616 K20	23579	S20	L	22	16	16	16	11	2	125	22	11
P92 S CXCBL 2020 K20	10204	S20	L	22	20	20	20	11	2	125	22	11
P92 S CXCBL 2525 M20	10206	S20	L	22	25	25	25	11	2	150	22	11
P92 S CXCBR 1616 K20	23576	S20	R	22	16	16	16	11	2	125	22	11
P92 S CXCBR 2020 K20	10203	S20	R	22	20	20	20	11	2	125	22	11
P92 S CXCBR 2525 M20	10205	S20	R	22	25	25	25	11	2	150	22	11

Fitting inserts, see below

7

P92 S CXCBL..11

System P92-S

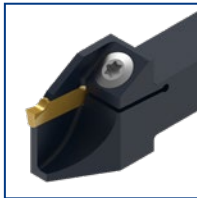

LH holder
Radially reinforced

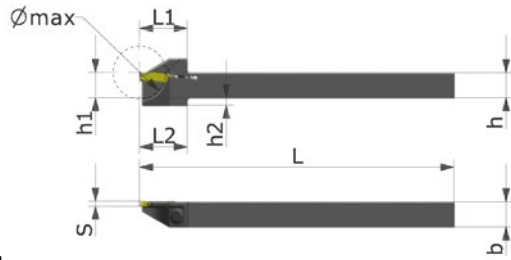

P92 S CXCBR..11

System P92-S



RH holder
Radially reinforced

WG380 Ref.	ID-Nr.	pocket size	↻	Ø max	h	h1	h2	b	S	L	L1	L2	
P92 S CXCBL 1010 K20 11	19260	S20	L	22	10	10	3	10	2	125	19	19	9
P92 S CXCBL 1212 K20 11	18547	S20	L	22	12	12	-	12	2	125	19	-	4
P92 S CXCBL 1616 K20 11	23571	S20	L	22	16	16	-	16	2	125	19,5	-	4
P92 S CXCBL 2020 K20 11	23577	S20	L	22	20	20	-	20	2	125	22	-	11
P92 S CXCBL 2525 M20 11	23578	S20	L	22	25	25	-	25	2	150	22	-	11
P92 S CXCBR 1010 K20 11	19259	S20	R	22	10	10	3	10	2	125	19	19	9
P92 S CXCBR 1212 K20 11	18548	S20	R	22	12	12	-	12	2	125	19	-	4
P92 S CXCBR 1616 K20 11	23570	S20	R	22	16	16	-	16	2	125	19,5	-	4
P92 S CXCBR 2020 K20 11	23574	S20	R	22	20	20	-	20	2	125	22	-	11
P92 S CXCBR 2525 M20 11	23575	S20	R	22	25	25	-	25	2	150	22	-	11

Fitting inserts

p. 226, 227, 252	p. 229	p. 230	p. 143-144	p. 145
			p. 146-147	p. 149

Reinforced parting off blades with dovetail shank

P92 S CXCBL..X
System P92-S

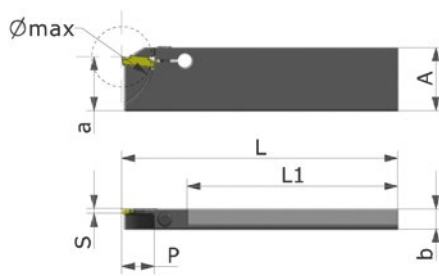

P92 S CXCBR..X
System P92-S



WG380 Ref.	ID-Nr.	pocket size	()	A	a	Ø max	b	P	S	L	L1	
P92 S CXCBL 2608 X20R	20123	S20	L	26	21,4	24	8	12,0	2,0	110	84,0	4
P92 S CXCBL 2608 X20L	21612	S20	L	26	21,4	24	8	12,0	2,0	110	84,0	4
P92 S CXCBR 2608 X20R	21610	S20	R	26	21,4	24	8	12,0	2,0	110	84,0	4
P92 S CXCBR 2608 X20L	21611	S20	R	26	21,4	24	8	12,0	2,0	110	84,0	4

Remark

Blades and tool blocks with the same "A" dimension fit together.

Example for application you will find on page 100

Fitting inserts and tool blocks

Torque p. 226, 227, 252 Tech. Section p. 229 pocket size p. 230 Fitting inserts and tool blocks p. 143-144, p. 145, p. 146-147, p. 182

Boring bars with internal cooling for internal grooving

P92 S CGL
System P92-S

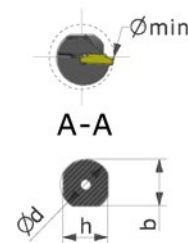
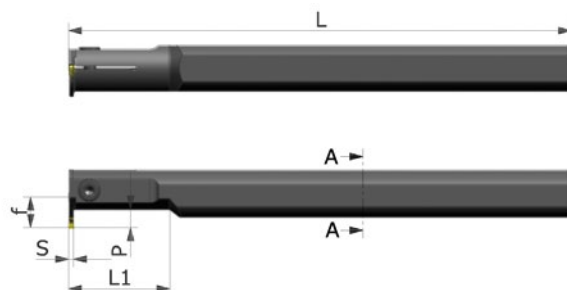

P92 S CGR
System P92-S



WG390 Ref.	ID-Nr.	pocket size	()	Ø min	Ø d	h	b	f	P	S	L	L1	
P92 S CGL 0012 M20	19258	S20	L	15,5	12	11	-	9	5,5	2	150	22	27
P92 S CGL 0016 P20	10190	S20	L	20,0	16	15	15,5	11	7,0	2	170	26	7
P92 S CGL 0020 R20	10192	S20	L	25,0	20	18	18,5	13	7,0	2	200	40	6
P92 S CGL 0025 R20	10194	S20	L	27,0	25	23	23,0	12	7,0	2	200	50	6
P92 S CGR 0012 M20	20308	S20	R	15,5	12	11	-	9	5,5	2	150	22	27
P92 S CGR 0016 P20	10189	S20	R	20,0	16	15	15,5	11	7,0	2	170	26	7
P92 S CGR 0020 R20	10191	S20	R	25,0	20	18	18,5	13	7,0	2	200	40	6
P92 S CGR 0025 R20	10193	S20	R	27,0	25	23	23,0	12	7,0	2	200	50	6

Fitting inserts

Torque p. 226, 227, 252 Tech. Section p. 229 pocket size p. 230 Fitting inserts p. 143-144, p. 145, p. 146-147

Inserts with 1 edge for grooving and turning

KHTNS

System P92-S

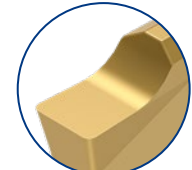
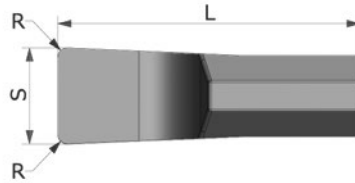
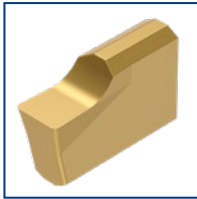

Enlarged view

WG300 Ref.	PM NANOSPEED ID-Nr.	pocket size	⌀	L ±0,1	R	S ±0,10
KHTNS 2	36299	SK20	N	6,35	0,2	2,0
KHTNSF 2	38497	SK20	N	6,00	0,0	2,0

Remark

Inserts marked with "F" have ground cutting edges without corner radius.
e.g. HTNSF



p. 155



p. 229



p. 230



p. 232



p. 155

Fitting tools

Internal threading inserts with 1 edge for Whitworth and ISO Full profile

KHTNG IR

System P92-S

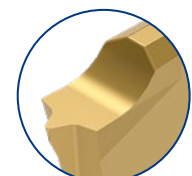
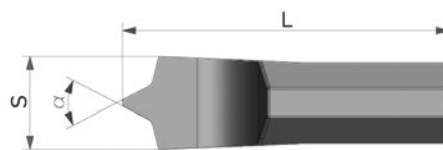
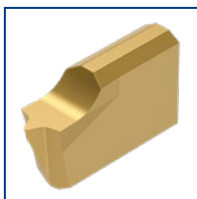

Enlarged view

WG260 Ref.	KM	PM NANOSPEED ID-Nr.	pocket size	⌀	L ±0,1	S	α
KHTNG 2 IR ISO 050	38504	38509	SK20	0,50	6,35	2,00	60°
KHTNG 2 IR ISO 100	38505	38510	SK20	1,00	6,35	2,00	60°
KHTNG 2 IR ISO 150	38506	38511	SK20	1,50	6,35	2,00	60°
KHTNG 2 IR 14W	38507	38512	SK20	14Gg	6,35	2,00	55°
KHTNG 2 IR 19W	38508	38513	SK20	19Gg	6,35	2,00	55°



p. 155



p. 229



p. 230



p. 232



p. 155

Fitting tools

Inserts for grooving and parting off | Hard material machining

KHTNS

System P92 S

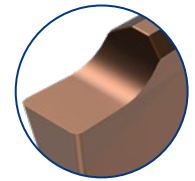
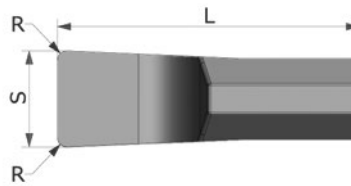
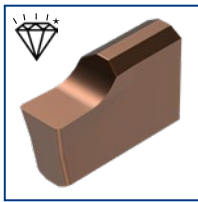

Enlarged view

WG302 Ref.	KM Hardlox2	pocket size	()	L ±0,1	R	S ±0,10
	ID-Nr.					
KHTNS 2	38770	SK20	N	6,35	0,2	2,0

Remark

Inserts for small diameters.

Fitting tools



Boring bars with internal cooling for internal grooving

P92 S CGL...M20C

System P92-S



LH

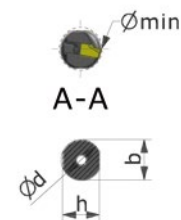
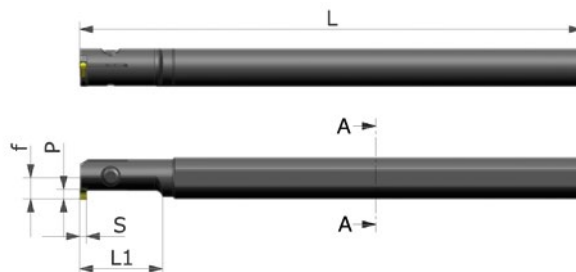

P92 S CGR...M20C

System P92-S



RH

WG390 Ref.	ID-Nr.	pocket size	()	Ø min	Ø d	h	b	f	P	S	L	L1	
P92 S CGL 0012 M20C	35943	SK20	L	12	12	11	-	6,25	2,5	2,0	150	22	27
P92 S CGR 0012 M20C	35007	SK20	R	12	12	11	-	6,25	2,5	2,0	150	22	27

Attention

When using KHTNSF 2 inserts reduce max. depth to 2.1 mm.

How to write an order:

1 pc. P92 S CGR 0012 M20C or: **1 pc. ID-Nr. 35007**
 10 pcs. KHTNG 2 IR ISO 050 PM NANOSPEED or: **10 pcs. ID-Nr. 38509**

Fitting inserts



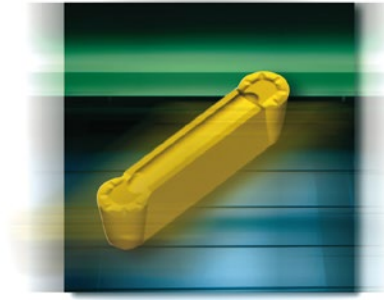

One edge cutting system

Parting off and grooving

- ▶ *Flex Fix*
- ▶ *Passt Perfekt*
- ▶ *Standard Design*



One edge cutting system

Parting off and grooving

The striking beauty of Flex Fix products



Construction and the way, these perfect grooving and parting off tools fit together

Just a few degrees in the right direction, lead to a new technique, which solves the old and well known system problems like

- ▶ Loss of center height
- ▶ Opening of insert pocket
- ▶ Fatigue of material
- ▶ Insert creeping

and increase tool life by **120 %**, stated by absolute authentic test series, compared with the system passt perfekt.

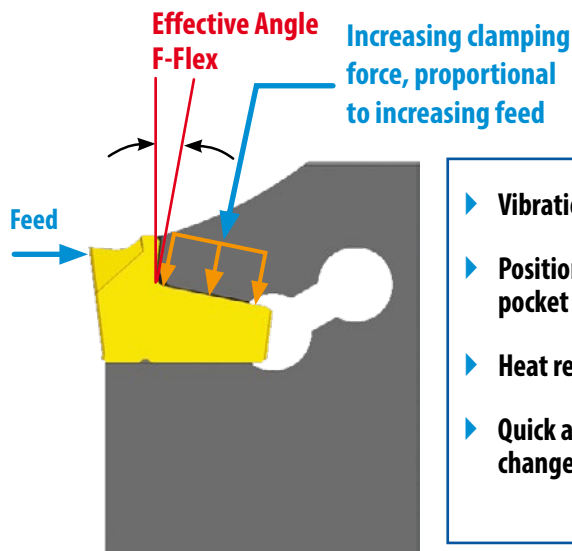

- ▶ Vibrations → 0
- ▶ Positioning in insert pocket → perfect
- ▶ Heat rejection improved
- ▶ Quick and defined insert change

Testmaterial	Quantity Flex Fix	Quantity passt perfekt	Result in %
1.0277 (hexagonal)	220	180	22 % more
1.7227 (Ø 45mm)	265	130	103 % more
1.4301 (Ø 45mm)	85	25	240 % more

Increased tool life by **120 %**

One edge cutting system

Parting off and grooving

Grooving

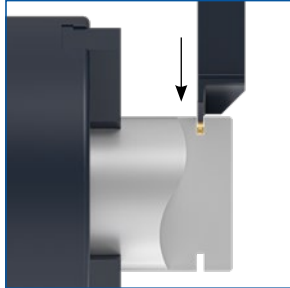

Parting off and grooving IFN

Grooving, the major edge cuts a groove

Parting off

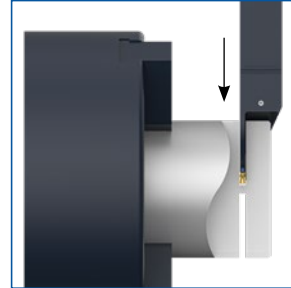

Parting off BFN

The major edge **parts off** a component.

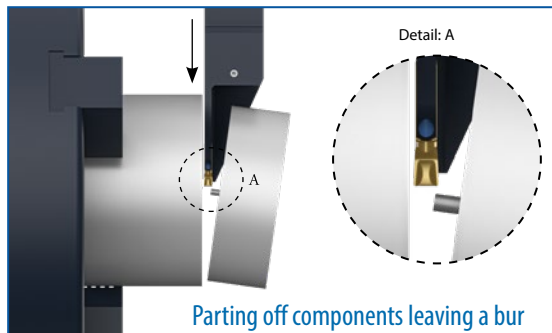

Parting off components leaving a burr

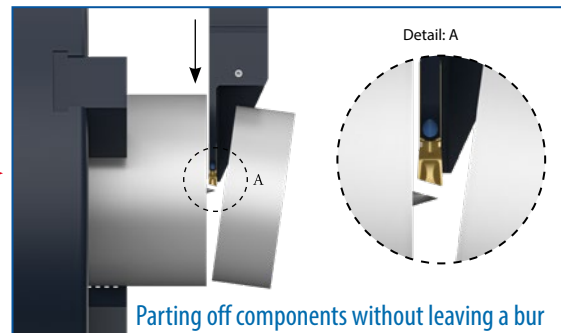

Parting off components without leaving a burr

Neutral inserts, inserts with lead angle right and lead angle left

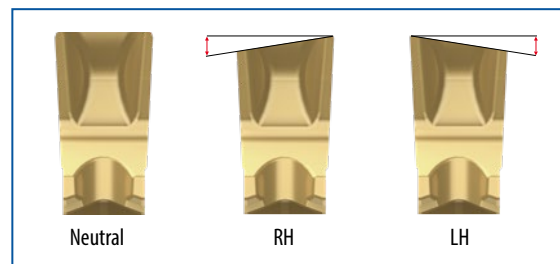

Neutral

RH

LH

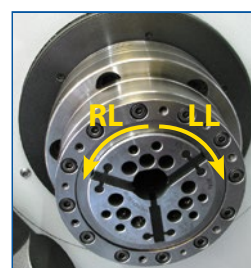

CCW and CW rotation

View into the spindle:

RH or CCW: Workpiece or bar rotates counter clockwise (German: „Rechtslauf“)

LH or CW: Workpiece or bar rotates clockwise (German: „Linkslauf“)

Parting off and grooving inserts

BF N/R/L
FLEX FIX

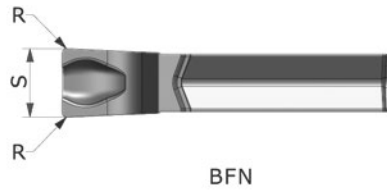
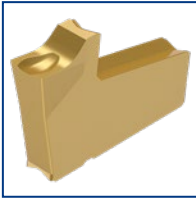

BFN

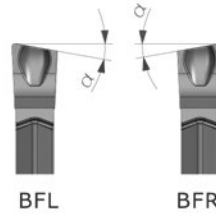

BFL

BFR

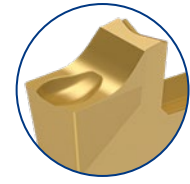

Enlarged view

WG0022 Ref.	KM TILOX ID-Nr.	KM NANOSPEED ID-Nr.	KM HYPERSPEED ID-Nr.	pocket size	(C)	R	s ±0.05	α°
BFN 2	43199	43201	43202	FF2	N	0,2	2,0	0
BFN 3	43203	43204	41172	FF3	N	0,2	3,0	0
BFN 4	43205	43207	43208	FF4	N	0,2	4,0	0
BFL 2 8D		43235		FF2	L	0,2	2,0	8
BFL 3 8D		43239		FF3	L	0,2	3,0	8
BFL 4 8D		43243		FF4	L	0,2	4,0	8
BFR 2 8D		43211		FF2	R	0,2	2,0	8
BFR 3 8D		43215		FF3	R	0,2	3,0	8
BFR 4 8D		43219		FF4	R	0,2	4,0	8

BF-Parting off geometry

Grooved parting off edge with reinforced flanks. The deep and spacious chip-trough gives excellent chip control. To be used on almost all materials.

8

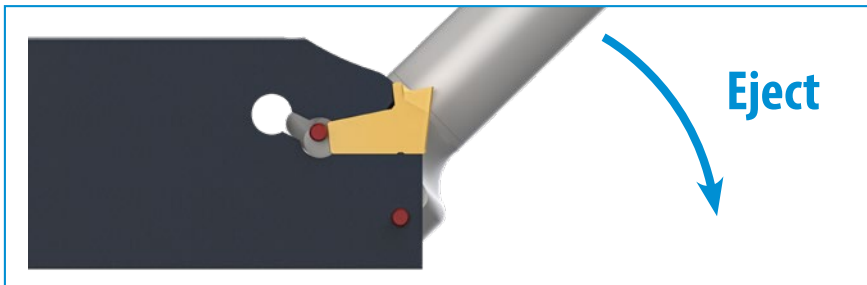

Eject

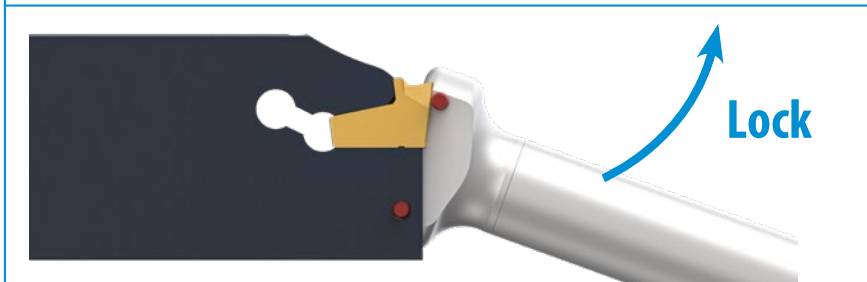

Lock

FLEX FIX insert changing

easy
safe
quick

Fitting tools

- 

p. 163-166, 196
- 

p. 229
- 

p. 230
- 

p. 232
- 

p. 163
- 

p. 164
- 

p. 164
- 

p. 165
- 

p. 166-167
- 

p. 195-196

Parting off and grooving inserts

IFN
FLEX FIX

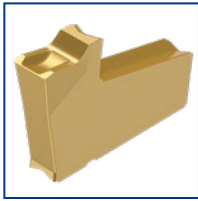

IFN



Enlarged view

WG0022 Ref.	KM TILOX ID-Nr.	KM NANOSPEED ID-Nr.	KM CARBOSPEED ID-Nr.	pocket size	⌀	R	S ±0.05
IFN 2	43260	43262	43261	FF2	N	0,2	2,0
IFN 3	39203	43259	40017	FF3	N	0,2	3,0
IFN 4	43264	43266	43265	FF4	N	0,2	4,0

IF Geometry with its cutting edge strengthening, ground chamfer is recommended for:

- Alloy steels
- Stainless steels
- Interrupted cuts

Ground chamfer

**IFN in action on interrupted cutting.
Negative chamfer reinforces
the cutting edge.**

- Fitting tools**
- Internal cooling
p. 163-166, 196
 - Tech. Section
p. 229
 - pocket size
p. 230
 - Intersection (main cutting edge)
p. 232
 - p. 163
 - p. 164
 - p. 164
 - p. 165
 - p. 166-167
 - p. 195-196

Parting off and grooving inserts

SF N/R/L
FLEX FIX

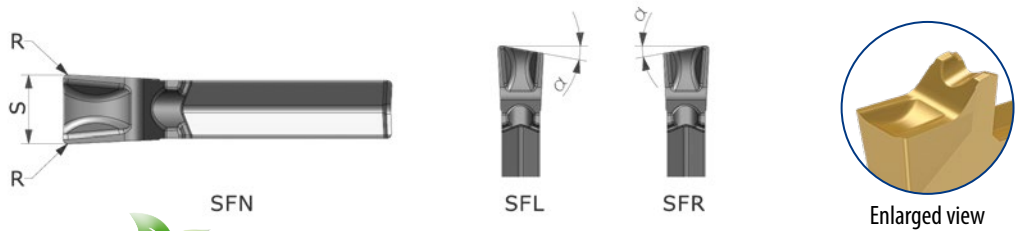
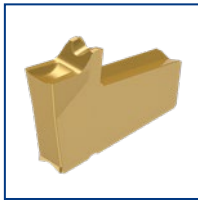

WG0022 Ref.	KM TILOX ID-Nr.	KM NANOSPEED ID-Nr.	KM CARBOSPEED ID-Nr.	pocket size	()	R	S ±0.05	α°
SFN 2	43087	43169	43168	FF2	N	0,2	2,0	0
SFN 3	38635	43170	40018	FF3	N	0,2	3,0	0
SFN 4	43171	43173	43172	FF4	N	0,2	4,0	0
SFL 2 6D		43189		FF2	L	0,2	2,0	6
SFL 3 6D		43192		FF3	L	0,2	3,0	6
SFL 4 6D		43196		FF4	L	0,2	4,0	6
SFR 2 6D		43178		FF2	R	0,2	2,0	6
SFR 3 6D		43181		FF3	R	0,2	3,0	6
SFR 4 6D		43185		FF4	R	0,2	4,0	6

SF-Geometry SUPERNOVA

The arc shaped cutting edge with its reinforced flanks achieves ideal chips. Recommended for free cutting and low alloy steels and stainless steels, also to be used on unstable machine tools.



Economy Line products
Excellent quality at attractive prices.
Achieved with most modern manufacturing methods.

Fitting tools, see below

IFN ALU
Flex Fix

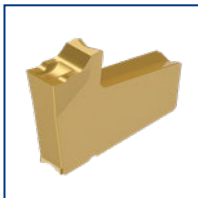

WG0022 Ref.	KM ID-Nr.	KM ALUSPEED ID-Nr.	pocket size	()	R	S ±0.05
IFN 2 ALU	47727	47730	FF2	N	0,2	2,0
IFN 3 ALU	47728	47731	FF3	N	0,2	3,0
IFN 4 ALU	47729	47732	FF4	N	0,2	4,0

The new IF Alu geometry has got a horizontally ground cutting edge with a flat chip breaker for high speed chip removal. The geometry is positive and sharply ground and is recommended for **nonferrous heavy metals, pipes, thinwalled parts, unstable components, free cutting materials and titanium.**

Fitting tools



Parting off holders for FLEX FIX inserts

F16 L 42
FLEX FIX

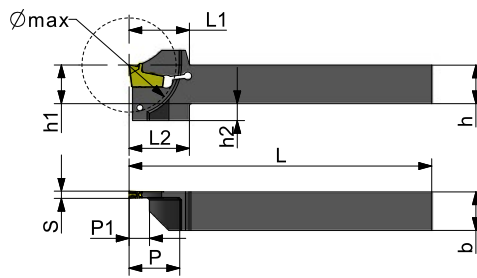
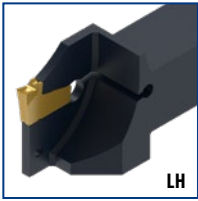

F16 R 42
FLEX FIX

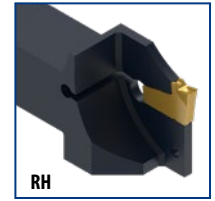

WG3201 Ref.	ID-Nr.	pocket size	()	Ø max	h	h1	h2	b	P1	S	L	L1	L2	
F16 L 1616 K20 42	43330	FF2	L	42	16	16	7	16	8	2,0	125	25	25	AWF16
F16 L 2020 K20 42	43333	FF2	L	42	20	20	3	20	8	2,0	125	25	25	AWF16
F16 L 2525 M20 42	43336	FF2	L	42	25	25	0	25	8	2,0	150	25	25	AWF16
F16 L 1616 K30 42	43331	FF3	L	42	16	16	7	16	8	3,0	125	25	25	AWF16
F16 L 2020 K30 42	43334	FF3	L	42	20	20	3	20	8	3,0	125	25	25	AWF16
F16 L 2525 M30 42	43337	FF3	L	42	25	25	0	25	8	3,0	150	25	25	AWF16
F16 L 1616 K40 42	43332	FF4	L	42	16	16	7	16	8	4,0	125	25	25	AWF16
F16 L 2020 K40 42	43335	FF4	L	42	20	20	3	20	8	4,0	125	25	25	AWF16
F16 L 2525 M40 42	49376	FF4	L	42	25	25	0	25	8	4,0	150	25	25	AWF16
F16 R 1616 K20 42	43322	FF2	R	42	16	16	7	16	8	2,0	125	25	25	AWF16
F16 R 2020 K20 42	43325	FF2	R	42	20	20	3	20	8	2,0	125	25	25	AWF16
F16 R 2525 M20 42	43328	FF2	R	42	25	25	0	25	8	2,0	150	25	25	AWF16
F16 R 1616 K30 42	43323	FF3	R	42	16	16	7	16	8	3,0	125	25	25	AWF16
F16 R 2020 K30 42	43326	FF3	R	42	20	20	3	20	8	3,0	125	25	25	AWF16
F16 R 2525 M30 42	43329	FF3	R	42	25	25	0	25	8	3,0	150	25	25	AWF16
F16 R 1616 K40 42	43324	FF4	R	42	16	16	7	16	8	4,0	125	25	25	AWF16
F16 R 2020 K40 42	43327	FF4	R	42	20	20	3	20	8	4,0	125	25	25	AWF16
F16 R 2525 M40 42	49377	FF4	R	42	25	25	0	25	8	4,0	150	25	25	AWF16

FLEX FIX - Holders and blades with internal cooling

F16 L 42 HP

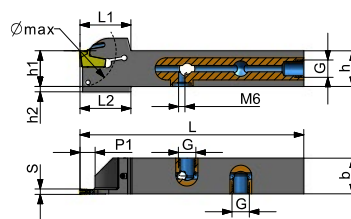

F16 R 42 HP



WG3205 Ref.	ID-Nr.	pocket size	()	Ø max	h	h1	h2	b	P1	S	L	L1	L2	
F16 L 2020 K30 42HP G1/8	57216	FF3	L	42	20	20	3	20	8	3,0	125	28,5	25	AWF16
F16 L 2525 M30 42HP G1/8	57220	FF3	L	42	25	25	0	25	8	3,0	150	28,5	25	AWF16
F16 R 2020 K30 42HP G1/8	57223	FF3	R	42	20	20	3	20	8	3,0	125	28,5	25	AWF16
F16 R 2525 M30 42HP G1/8	57226	FF3	R	42	25	25	0	25	8	3,0	150	28,5	25	AWF16

Tailor made high pressure cooling system available.
More information at page 215

Fitting inserts
 p. 229
 p. 230
 p. 160-162

Parting off holders for FLEX FIX inserts

F16 L 65
FLEX FIX

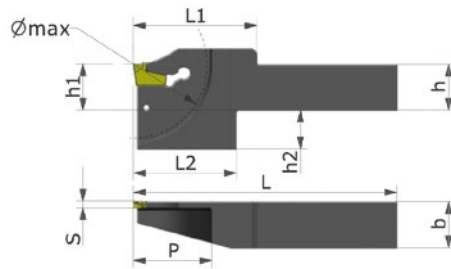
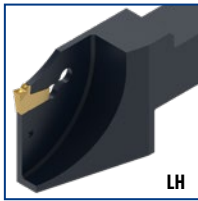

F16 R 65
FLEX FIX

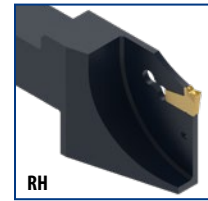

WG3201 Ref.	ID-Nr.	pocket size	()	Ø max	h	h1	h2	b	S	L	L1	L2	
F16 L 2020 X30 65	38875	FF3	L	65	20	20	17	20	3,0	115	54	45	AWF16
F16 L 2525 X30 65	43320	FF3	L	65	25	25	12	25	3,0	140	54	45	AWF16
F16 L 2020 X40 65	43319	FF4	L	65	20	20	17	20	4,0	115	54	45	AWF16
F16 L 2525 X40 65	43321	FF4	L	65	25	25	12	25	4,0	140	54	45	AWF16
F16 R 2020 X30 65	38878	FF3	R	65	20	20	17	20	3,0	115	54	45	AWF16
F16 R 2525 X30 65	43317	FF3	R	65	25	25	12	25	3,0	140	54	45	AWF16
F16 R 2020 X40 65	43316	FF4	R	65	20	20	17	20	4,0	115	54	45	AWF16
F16 R 2525 X40 65	43318	FF4	R	65	25	25	12	25	4,0	140	54	45	AWF16

Tailor made hi pressure cooling system available.
More information at page 215

Fitting inserts

p. 229 p. 230 p. 160-162

FLEX FIX Holders and blades with internal cooling

F16 L 65 HP

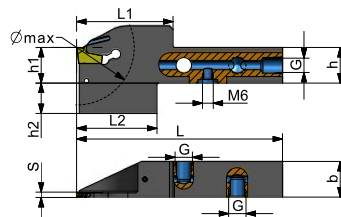

F16 R 65 HP



WG3205 Ref.	ID-Nr.	pocket size	G1	()	Ø max	h	h1	h2	b	P1	S	L	L1	L2	
F16 L 2020 X30 65HP G1/8	57217	FF3	5,0	L	65	20	20	17	20	-	3,0	115	54	45	AWF16
F16 L 2525 X30 65HP G1/8	57222	FF3	5,0	L	65	25	25	12	25	-	3,0	140	54	45	AWF16
F16 R 2020 X30 65HP G1/8	57225	FF3	5,0	R	65	20	20	17	20	-	3,0	115	54	45	AWF16
F16 R 2525 X30 65HP G1/8	57227	FF3	5,0	R	65	25	25	12	25	-	3,0	140	54	45	AWF16

Fitting inserts

p. 229 p. 230 p. 160-162

Reinforced parting off blades for FLEX FIX inserts

F16 L 2608
FLEX FIX

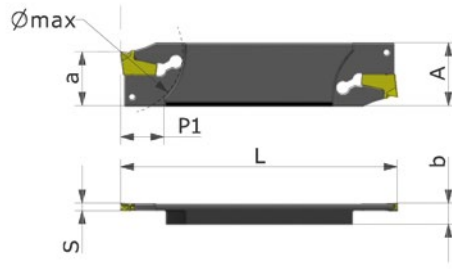

F16 R 2608
FLEX FIX

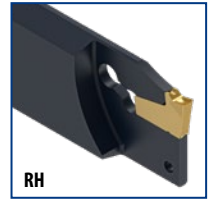

WG3101 Ref.	ID-Nr.	pocket size	(C)	A	a	Ø max	b	P1	S	L	
F16 L 2608 J30 R 50	43313	FF3	L	26	21,4	50	8	17	3,0	110	AWF16
F16 R 2608 J30 L 50	43312	FF3	R	26	21,4	50	8	17	3,0	110	AWF16

Fitting inserts, see below

F16 L 3208
FLEX FIX

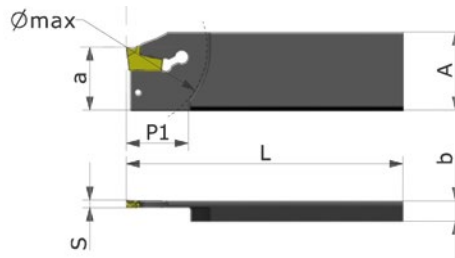

F16 R 3208
FLEX FIX

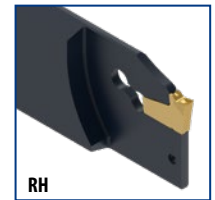

WG3101 Ref.	ID-Nr.	pocket size	(C)	A	a	Ø max	b	P1	S	L	
F16 L 3208 J30 R 65	43315	FF3	L	32	25	65	8	24,5	3,0	110	AWF16
F16 L 3208 J30 L 65	53794	FF3	L	32	25	65	8	24,5	3,0	110	AWF16
F16 R 3208 J30 L 65	43314	FF3	R	32	25	65	8	24,5	3,0	110	AWF16
F16 R 3208 J30 R 65	52553	FF3	R	32	25	65	8	24,5	3,0	110	AWF16

Fitting inserts



p. 229

p. 230

p. 160-162

p. 182, 183

Key for FLEX FIX tools

AW F16
FLEX FIX



WG355 Ref.	ID-Nr.	
AW F16	39880	AW F16 1
AW F16 1	39881	

Remark: The key is added to each FLEX FIX tool delivery.

Parting off blades for FLEX FIX inserts

F16 T
FLEX FIX

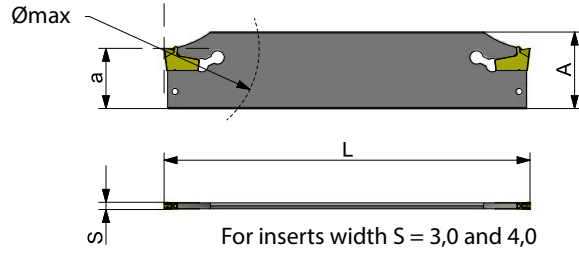

WG3101 Ref.	ID-Nr.	pocket size	a	Ø max.	A	P1	S	L	
F16 T 26 2	41093	FF2	21,4	42	26	15	2	110	AWF 16
F16 T 26 3	38743	FF3	21,4	75	26	-	3	110	AWF 16
F16 T 26 4	41096	FF3	21,4	80	26	-	4	110	AWF 16
F16 T 32 2	41094	FF2	25	42	32	15	2	150	AWF 16
F16 T 32 3	35217	FF3	25	100	32	-	3	150	AWF 16
F16 T 32 4	41095	FF3	25	100	32	-	4	150	AWF 16

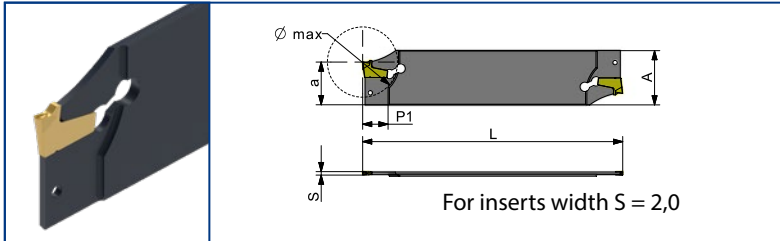

Fitting inserts



p. 229



p. 230



p. 160-162



p. 182

FLEX FIX Parting off blades

F16 THP

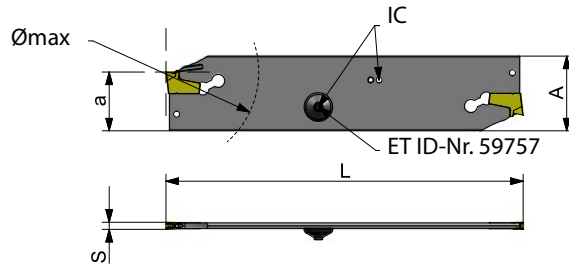
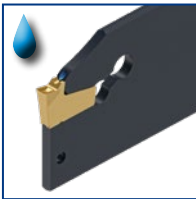

WG3105 Ref.	ID-Nr.	pocket size	a	Ø max.	A	S	L	
F16 T 26 30 HP	57323	FF3	21,4	75	26	3	110	AWF 16
F16 T 32 30 HP	57324	FF3	25	100	32	3	150	AWF 16

Tool blocks for holders with internal cooling

Extract from Megacut Catalogue

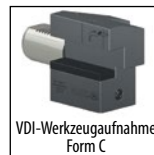

Fitting inserts



p. 229



p. 230



p. 160-162

FLEX FIX blades for Churchill system

F16 PM 17 5

FLEX FIX

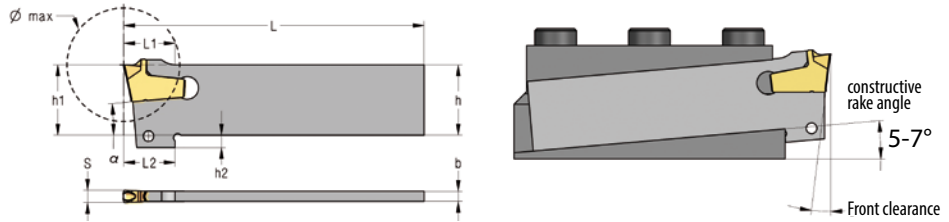

WG3101 Ref.	ID-Nr.	pocket size	(C)	Ømin	Recommended Ømax	h	h1	h2	b	S	L	L1	L2	Constructive rake angle	
F16 PM2 1725	55280	FF2	N	25	42	17	17,3	3	2,4	2,0	110	12,5	12,5	5°-7°	AWF 16
F16 PM3 1735	54454	FF3	N	25	42	17	17,3	3	2,4	3,0	110	12,5	12,5	5°-7°	AWF 16

F16 PM 17 0

FLEX FIX

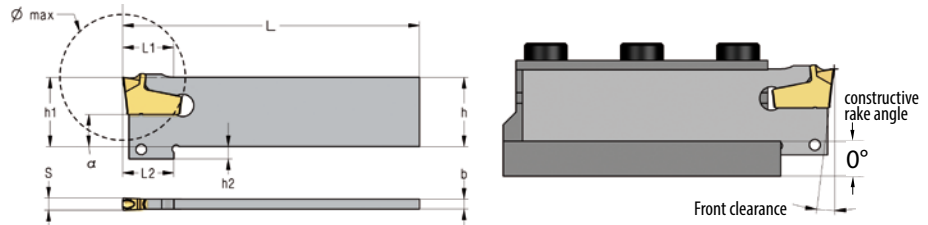

WG3101 Ref.	ID-Nr.	pocket size	(C)	Ømin	Recommended Ømax	h	h1	h2	b	S	L	L1	L2	Constructive rake angle	
F16 PM2 1720	55281	FF2	N	25	42	17	17,3	3	2,4	2,0	110	12,5	12,5	0°	AWF 16
F16 PM3 1730	54453	FF3	N	25	42	17	17,3	3	2,4	3,0	110	12,5	12,5	0°	AWF 16

F16 PM 22 5

FLEX FIX

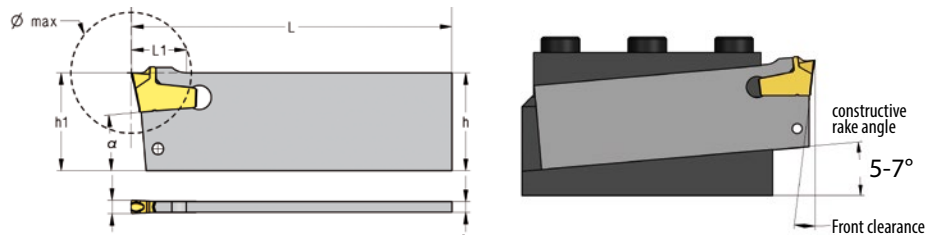

WG3101 Ref.	ID-Nr.	pocket size	(C)	Ømin	Recommended Ømax	h	h1	h2	b	S	L	L1	L2	Constructive rake angle	
F16 PM2 2225	57362	FF2	N	25	42	22,2	22,2	0	2,4	2,0	125	12,5	0	5°-7°	AWF 16
F16 PM3 2235	57363	FF3	N	25	75	22,2	22,2	0	2,4	3,0	125	12,5	0	5°-7°	AWF 16

Application: Put the Flex Fix blades into the Churchill holder which are fixed on the machine-tools.

Fitting inserts



Tech. Section
p. 229



pocket size
p. 230



p. 160-162

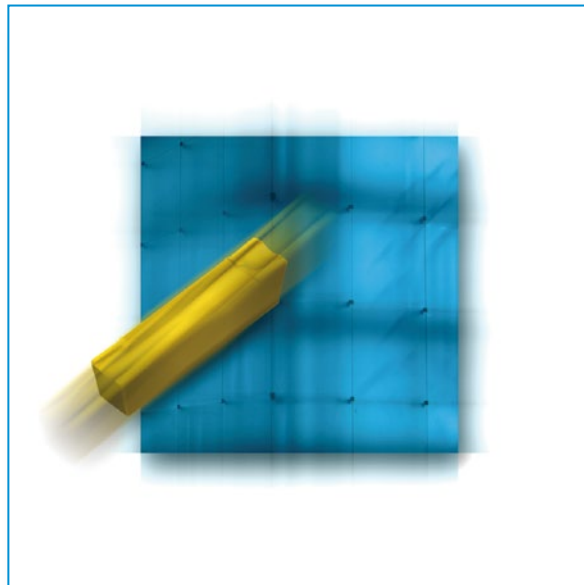
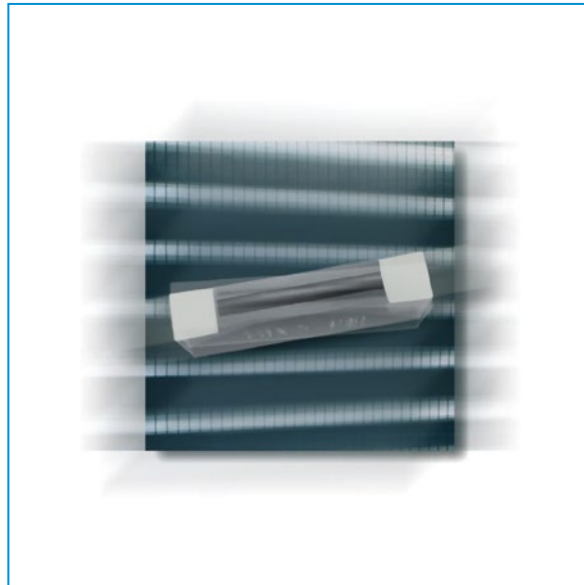
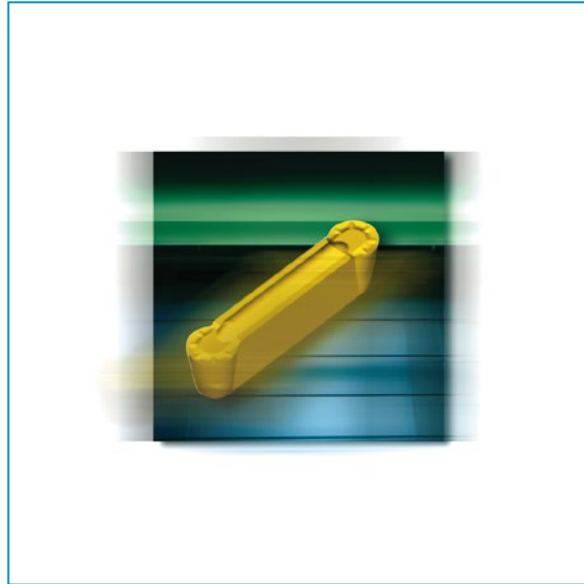

„Passt Perfekt“ system

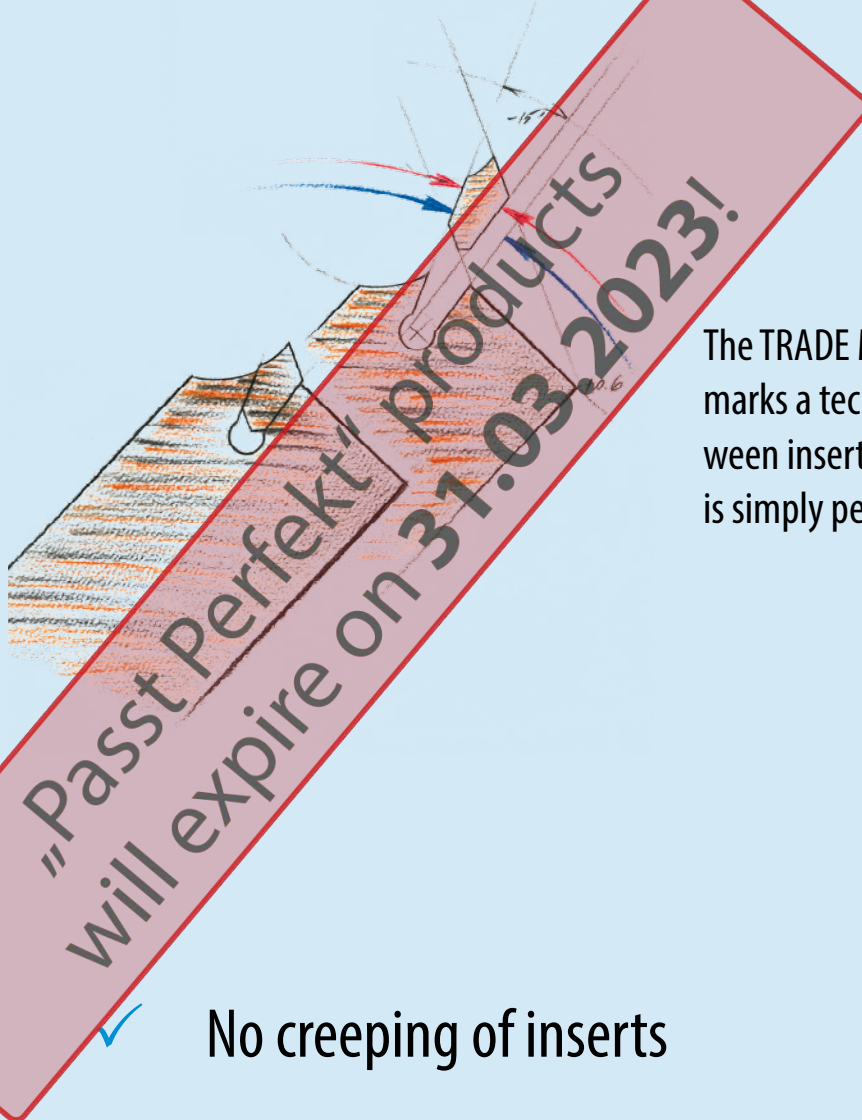

The TRADE MARK „passt perfekt“ marks a technique: the fit between insert and insert pocket is simply perfect.

- ✓ No creeping of inserts
- ✓ No vibrations
- ✓ Rigid tool unit
- ✓ Clean faces
- ✓ Constant tool life
- ✓ Reliable machining

Parting off and grooving inserts

SNPN
passt perfekt

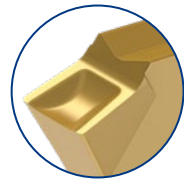
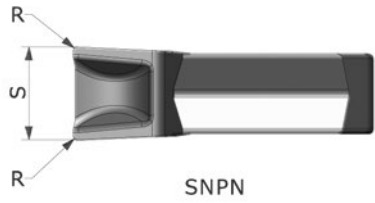
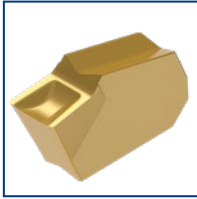

Enlarged view

WG3251 Ref.	PM NANOSPEED ID-Nr.	GF110 TILOX	pocket size		R	S ±0,1
SNPN 20	20418	47978	PP2	N	0,2	2,0
SNPN 3	11244	22695	PP3	N	0,2	3,1
SNPN 4	11252	40623	PP4	N	0,2	4,1
SNPN 5	47979	11257	PP5	N	0,2	5,1

SUPERNOVA

The arc shaped cutting edge with its reinforced flanks achieves ideal chips. Recommended for free cutting and low alloy steels and stainless steels, also to be used on unstable machine tools.

8

SNP N/R/L-20

ITP N/R/L-20

The new pocket

Comparison between the old SNTN-2 types and the new SNPN-20 types.

- Long guide surfaces transfer high gripping power
- Reduced cutting edge width to 2,0 mm
- Vibration free, straight run

"Passt Perfekt" products will expire on 31.03.2023!

- Fitting tools**
- p. 229
 - p. 230
 - p. 232
 - p. 172
 - p. 173

Parting off inserts

BGP N/R/L F

passt perfekt

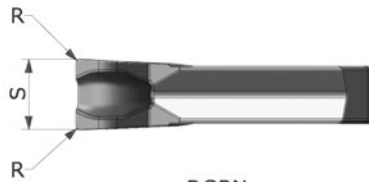
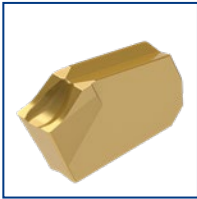

BGPN



BGPL

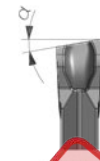

BGPR

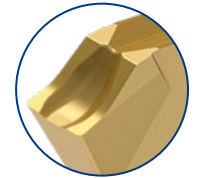

Enlarged view

WG0021 Ref.	PM NANOSPEED ID-Nr.	GF110 TILOX ID-Nr.	pocket size	()	R	S ±0,1	α°
BGPN 3	20439	48201	PP3	N	0,2	3,1	0
BGPNF 3	23663	48203	PP3	N	0,0	3,1	0
BGPN 4	26289	48202	PP4	N	0,2	4,1	0
BGPNF 4	26232	48204	PP4	N	0,0	4,1	0
BGPLF 3 8D	-	48198	PP3	L	0,0	3,1	8
BGPLF 3 12D	-	48197	PP3	L	0,0	3,1	12
BGPLF 4 8D	-	48200	PP4	L	0,0	4,1	8
BGPLF 4 12D	-	48199	PP4	L	0,0	4,1	12
BGPRF 3 8D	-	48210	PP3	R	0,0	3,1	8
BGPRF 3 12D	-	48209	PP3	R	0,0	3,1	12
BGPRF 4 8D	-	48212	PP4	R	0,0	4,1	8
BGPRF 4 12D	-	48211	PP4	R	0,0	4,1	12

BGP-Parting off Geometry

Grooved parting off edge with reinforced flanks. The deep and spacious chip-trough gives excellent chip control. To be used on almost all materials.

Inserts marked with "F" like BGPNF-3 are ground with R = 0 mm..

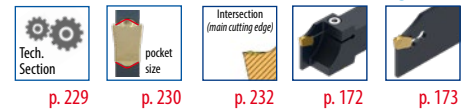

Parting off and grooving inserts

ITPN

passt perfekt

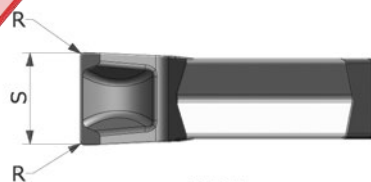
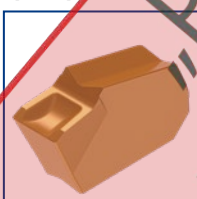

ITPN



Enlarged view

WG0021 Ref.	PM NANOSPEED ID-Nr.	GF110 TILOX ID-Nr.	pocket size	()	R	S ±0,1
ITPN 20	20400	47936	PP2	N	0,2	2,0
ITPN 3	10562	19854	PP3	N	0,2	3,1
ITPN 4	10594	19810	PP4	N	0,2	4,1
ITPN 5	47938	10599	PP5	N	0,2	5,1

IT Geometry with its cutting edge strengthening, ground chamfer is recommended for:

- Alloy steels
- Stainless steels
- Interrupted cuts

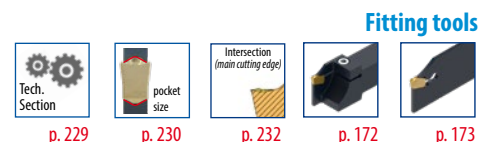

Parting off tool holders

CLPPL
passt perfekt

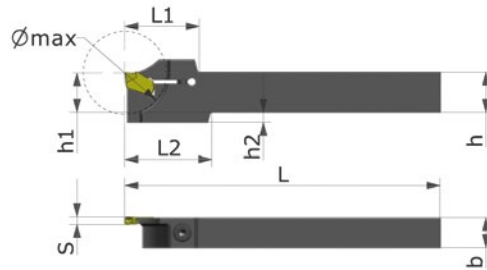
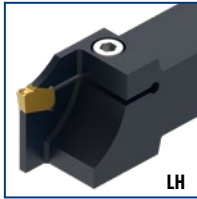

CLPPR
passt perfekt

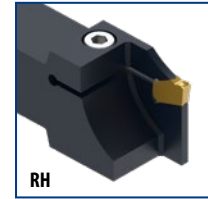

WG3801 Ref.	ID-Nr.	pocket size	()	Ø max	h	h1	h2	b	S	L	L1	L2	
CLPPL 1010 K20X	24248	PP2	L	28	10	10	10	10	2,0	125	26	36	11
CLPPL 1212 K20X	19741	PP2	L	28	12	12	8	12	2,0	125	26	33	11
CLPPL 1612 K20X	19743	PP2	L	28	16	16	4	12	2,0	125	26	31	11
CLPPL 2020 K20X	19745	PP2	L	40	20	20	5	20	2,0	125	33	33	5
CLPPL 2525 M20X	24249	PP2	L	40	25	25	0	25	2,0	150	36	-	2
CLPPL 1212 K30	10336	PP3	L	34	12	12	8	12	3,0	125	29	33	11
CLPPL 1612 K30	10340	PP3	L	34	16	16	4	12	3,0	125	29	34	11
CLPPL 2020 K30	10346	PP3	L	40	20	20	5	20	3,0	125	33	33	5
CLPPL 2525 M30	10356	PP3	L	40	25	25	0	25	3,0	150	36	-	2
CLPPL 1612 K40	10342	PP4	L	40	16	16	8	12	4,0	125	33	34	11
CLPPL 2020 K40	10348	PP4	L	53	20	20	5	20	4,0	125	40	40	5
CLPPL 2525 M40	10358	PP4	L	53	25	25	0	25	4,0	150	40	-	2
CLPPL 2525 P50	10360	PP5	L	80	25	25	15	25	5,0	170	56	62	2
CLPPR 1010 K20X	19739	PP2	R	28	10	10	10	10	2,0	125	26	36	11
CLPPR 1212 K20X	19740	PP2	R	28	12	12	8	12	2,0	125	26	33	11
CLPPR 1612 K20X	19742	PP2	R	28	16	16	4	12	2,0	125	26	31	11
CLPPR 2020 K20X	19744	PP2	R	40	20	20	5	20	2,0	125	33	33	5
CLPPR 2525 M20X	24247	PP2	R	40	25	25	0	25	2,0	150	36	-	2
CLPPR 1212 K30	10335	PP3	R	34	12	12	8	12	3,0	125	29	33	11
CLPPR 1612 K30	10339	PP3	R	34	16	16	4	12	3,0	125	29	34	11
CLPPR 2020 K30	10345	PP3	R	40	20	20	5	20	3,0	125	33	33	5
CLPPR 2525 M30	10355	PP3	R	40	25	25	0	25	3,0	150	36	-	2
CLPPR 1612 K40	10341	PP4	R	40	16	16	8	12	4,0	125	33	34	11
CLPPR 2020 K40	10347	PP4	R	53	20	20	5	20	4,0	125	40	40	5
CLPPR 2525 M40	10357	PP4	R	53	25	25	0	25	4,0	150	40	-	2
CLPPR 2525 P50	10359	PP5	R	80	25	25	15	25	5,0	170	56	62	2

8

Will expire on 31.03.2023!



p. 226, 227, 252



p. 229



p. 230



p. 170-171

Reinforced parting off holders

CLPPL..X
passt perfekt

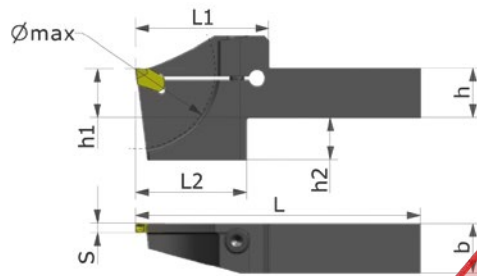

CLPPR..X
passt perfekt

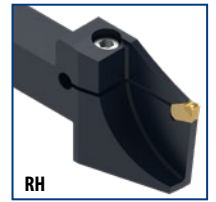

WG3801 Ref.	ID-Nr.	pocket size	(C)	Ø max	h	h1	h2	b	S	L	L1	L2	
CLPPL 2020 X30 65	10350	PP3	L	65	20	20	17	20	3,0	115	54	45	12
CLPPL 2525 X30 65	10362	PP3	L	65	25	25	12	25	3,0	140	54	45	12
CLPPL 2020 X40 65	10352	PP4	L	65	20	20	17	20	4,0	115	54	45	12
CLPPL 2525 X40 65	10364	PP4	L	65	25	25	12	25	4,0	140	54	45	12
CLPPR 2020 X30 65	10349	PP3	R	65	20	20	17	20	3,0	115	54	45	12
CLPPR 2525 X30 65	10361	PP3	R	65	25	25	12	25	3,0	140	54	45	12
CLPPR 2020 X40 65	10351	PP4	R	65	20	20	17	20	4,0	115	54	45	12
CLPPR 2525 X40 65	10363	PP4	R	65	25	25	12	25	4,0	140	54	45	12

Fitting inserts

p. 226, 227, 252
 p. 229
 p. 230
 p. 170-171

Parting off blades with autolock pocket

TMSPP
passt perfekt

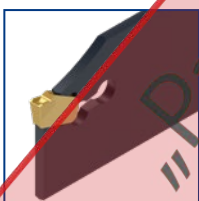

WG3101 Ref.	ID-Nr.	Plattensitzgröße	(C)	A	a	S	L	
TMSPP 26 20X	19732	PP2	N	26	21,4	2,0	110	16
TMSPP 26 3	10024	PP3	N	26	21,4	3,0	110	16
TMSPP 26 4	10025	PP4	N	26	21,4	4,0	110	16
TMSPP 32 20X	24245	PP2	N	32	25,0	2,0	150	16
TMSPP 32 3	10026	PP3	N	32	25,0	3,0	150	16
TMSPP 32 4	10027	PP4	N	32	25,0	4,0	150	16
TMSPP 32 5	10028	PP5	N	32	25,0	5,0	150	16

Remark

Blades and tool blocks with the same "A" dimension fit together.
Holder and inserts with the same "S" dimension fit together.

Key 1856 (Spare part 16) is added to the delievery.

Fitting inserts and tool blocks

p. 229
 p. 230
 p. 170-171
 p. 182, 183



Inserts for face grooving

PPTNL
passt perfekt

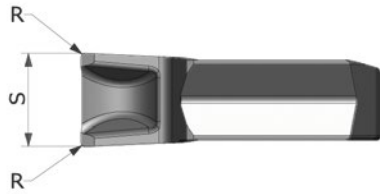

PPTNL



PPTNR

PPTNR
passt perfekt

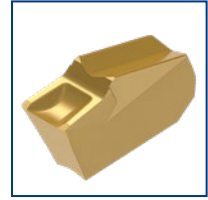

WG0031 Ref.	PM NANOSPEED	pocket size	()	R	S ±0,1
	ID-Nr.				
PPTNL 4	28858	PP4	L	0,2	4,1
PPTNL 5	47969	PP5	L	0,2	5,1
PPTNR 4	11209	PP4	R	0,2	4,1
PPTNR 5	11212	PP5	R	0,2	5,1

LH

PPTN R/L - Face grooving inserts

Special chip breaker and ground side clearances. Both features achieve efficient chip flow.

RH

„Passt Perfekt“ products will expire on 31.03.2023!

Fitting tools



p. 229



p. 230



p. 232



p. 175

Face grooving blades with autolock pocket

PPSMS L
passt perfekt

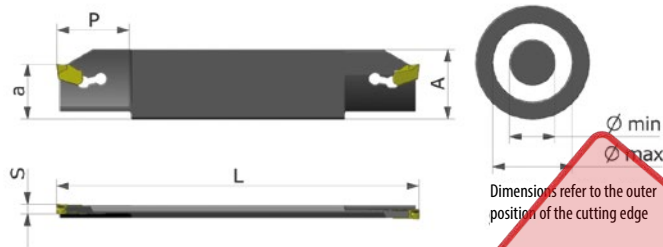

PPSMS R
passt perfekt



WG3151 Ref.	ID-Nr.	pocket size	()	A	a	Ø min-max	P	S	L	
PPSMS 85 4 L	28859	PP4	L	32	25	85-160	32	4,0	160	16
PPSMS 140 4 L	38491	PP4	L	32	25	140-260	32	4,0	160	16
PPSMS 240 4 L	38493	PP4	L	32	25	240-∞	32	4,0	160	16
PPSMS 85 5 L	26194	PP5	L	32	25	85-160	32	5,0	160	16
PPSMS 140 5 L	38492	PP5	L	32	25	140-260	32	5,0	160	16
PPSMS 240 5 L	38494	PP5	L	32	25	240-∞	32	5,0	160	16
PPSMS 85 4 R	10209	PP4	R	32	25	85-160	32	4,0	160	16
PPSMS 140 4 R	10207	PP4	R	32	25	140-260	32	4,0	160	16
PPSMS 240 4 R	38495	PP4	R	32	25	240-∞	32	4,0	160	16
PPSMS 85 5 R	10210	PP5	R	32	25	85-160	32	5,0	160	16
PPSMS 140 5 R	10208	PP5	R	32	25	140-260	32	5,0	160	16
PPSMS 240 5 R	38496	PP5	R	32	25	240-∞	32	5,0	160	16

„Passt Perfekt“ products will expire on 31.03.2023!

Key 1856 (Spare part 16) is added to the delivery.

Fitting tools

- p. 229
- p. 230
- p. 174
- p. 182, 183

Parting off and grooving inserts

SNT N/R/L
Standard Design

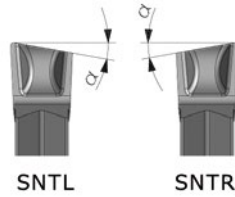
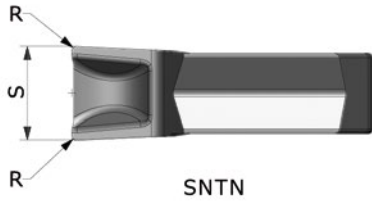
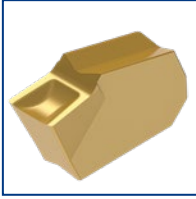

Enlarged view

WG325 Ref.	PM NANOSPEED ID-Nr.	GF110 CARBOSPEED ID-Nr.	pocket size	()	R	S ±0,1	α°
SNTN 2	47916	47917	SD2	N	0,2	2,2	0
SNTN 3	11330	47918	SD3	N	0,2	3,1	0
SNTN 4	11342	47919	SD4	N	0,2	4,1	0
SNTN 5	47920	47921	SD5	N	0,2	5,1	0
SNTR 2 6D	47922	47923	SD2	R	0,2	2,2	6
SNTR 3 6D	11391	47924	SD3	R	0,2	3,1	6
SNTR 4 6D	11411	47925	SD4	R	0,2	4,1	6
SNTR 5 6D	47926	47927	SD5	R	0,2	5,1	6
SNTL 2 6D	47910	47911	SD2	L	0,2	2,2	6
SNTL 3 6D	11392	47912	SD3	L	0,2	3,1	6
SNTL 4 6D	11412	47913	SD4	L	0,2	4,1	6
SNTL 5 6D	47914	47915	SD5	L	0,2	5,1	6

SUPERNOVA

The arc-shaped cutting edge with its reinforced flanks forms ideal chips. Recommended for free cutting and low alloy steels and stainless steels, also to be used on unstable machine tools.

8

The difference!

Standard Design...

„Standard Design“ Inserts
precision sintered top guide

„passt perfekt“ Inserts
ground top guide

Attention!

The two systems are **not interchangeable!**

Parting off and grooving inserts

IT N/R/L
Standard Design

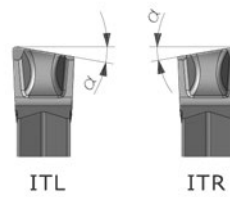
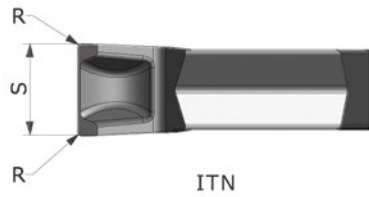

Enlarged view

WG002 Ref.	PM NANOSPEED ID-Nr.	GF110 CARBOSPEED ID-Nr.	pocket size	(C)	R	S ±0,1	α°
ITN 2	47890	47892	SD2	N	0,2	2,2	0
ITN 3	10497	47893	SD3	N	0,2	3,1	0
ITN 4	10515	47894	SD4	N	0,2	4,1	0
ITN 5	47896	47895	SD5	N	0,2	5,1	0
ITN 6	10527	-	SD6	N	0,2	6,35	0
ITR 2 4D	47898	47899	SD2	R	0,2	2,2	4
ITR 2 8D	47900	47901	SD2	R	0,2	2,2	8
ITR 3 4D	10791	47902	SD3	R	0,2	3,1	4
ITR 3 8D	10811	47903	SD3	R	0,2	3,1	8
ITR 4 4D	10837	47904	SD4	R	0,2	4,1	4
ITR 4 8D	10857	47905	SD4	R	0,2	4,1	8
ITR 5 4D	47906	47907	SD5	R	0,2	5,1	4
ITR 5 8D	47908	47909	SD5	R	0,2	5,1	8
ITL 2 4D	47877	47878	SD2	L	0,2	2,2	4
ITL 2 8D	47879	47880	SD2	L	0,2	2,2	8
ITL 3 4D	10792	47881	SD3	L	0,2	3,1	4
ITL 3 8D	10812	47882	SD3	L	0,2	3,1	8
ITL 4 4D	10838	47883	SD4	L	0,2	4,1	4
ITL 4 8D	10858	47884	SD4	L	0,2	4,1	8
ITL 5 4D	47885	47886	SD5	L	0,2	5,1	4
ITL 5 8D	47887	47888	SD5	L	0,2	5,1	8

IT Geometry with its cutting edge strengthening, ground chamfer is recommended for:

- Alloy steels
- Stainless steels
- Interrupted cuts

WG002 Ref.	GF110 CASTSPEED	GF110 CARBOSPEED	KM CASTSPEED	PM TILOX	PM CASTSPEED	(C)	R	S ±0,1	α°
ITN 3	53896	-	-	-	-	N	0,2	3,1	0
ITN 6	-	57772	57773	57774	57775	N	0,2	6,4	0

GF110 Castspeed for cast materials.

PM Castspeed for cast materials and steel applications in unstable conditions.

Fitting tools

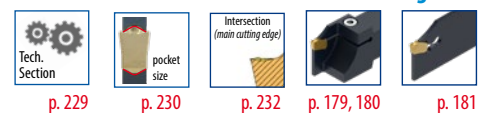

Parting off and grooving inserts

IT N/R/L ALU

Standard Design

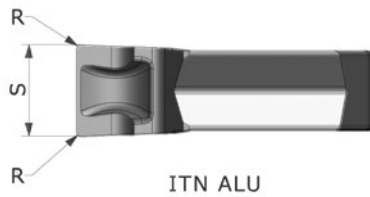

ITN ALU

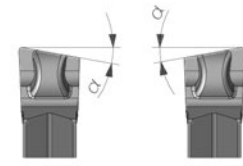

ITL ALU

ITR ALU



Enlarged view

WG002 Ref.	GF 110 ID-Nr.	PM NANOSPEED ID-Nr.	pocket size	()	R	S ±0,1	α°
ITN 2 ALU	29338	47891	SD2	N	0,2	2,2	0
ITN 3 ALU	10480	10485	SD3	N	0,2	3,1	0
ITN 4 ALU	10498	10503	SD4	N	0,2	4,1	0
ITR 2 4D ALU	29602	47897	SD2	R	0,2	2,2	4
ITR 3 4D ALU	20692	10771	SD3	R	0,2	3,1	4
ITR 4 4D ALU	29215	10817	SD4	R	0,2	4,1	4
ITL 2 4D ALU	32370	47876	SD2	L	0,2	2,2	4
ITL 3 4D ALU	21489	10772	SD3	L	0,2	3,1	4
ITL 4 4D ALU	29212	10818	SD4	L	0,2	4,1	4

ALU Geometry with sharply ground, positive cutting edge is recommended for:

- Nonferrous heavy metals
- Thinwalled parts
- Pipes
- Machining steels
- Unstable components

Fitting tools, see below

BGN /R/L

Standard Design

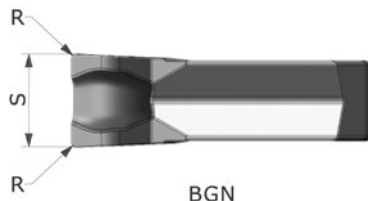
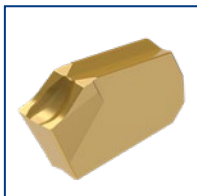

BGN

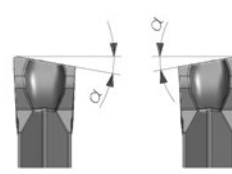

BGL

BGR

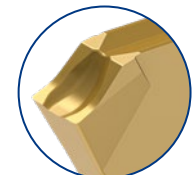

Enlarged view

WG002 Ref.	PM NANOSPEED ID-Nr.	GF110 CARBOSPEED ID-Nr.	pocket size	()	R	S ±0,1	α°
BGN 3	30874	48181	SD3	N	0,2	3,1	0
BGN 4	48183	48182	SD4	N	0,2	4,1	0
BGR 3 4D	48185	48184	SD3	R	0,2	3,1	4
BGR 3 8D	48187	48186	SD3	R	0,2	3,1	8
BGR 4 4D	48189	48188	SD4	R	0,2	4,1	4
BGR 4 8D	48191	48190	SD4	R	0,2	4,1	8
BGL 3 4D	48174	48173	SD3	L	0,2	3,1	4
BGL 3 8D	48176	48175	SD3	L	0,2	3,1	8
BGL 4 4D	48178	48177	SD4	L	0,2	4,1	4
BGL 4 8D	48180	48179	SD4	L	0,2	4,1	8

Fitting tools



p. 229



p. 230



p. 232



p. 179, 180



p. 181

Parting off holders

CLCBL
Standard Design

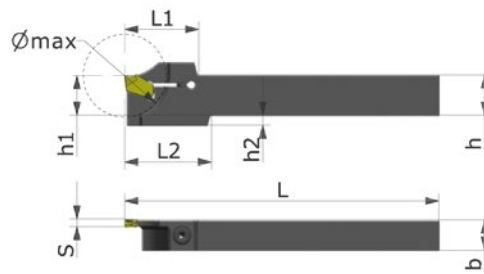
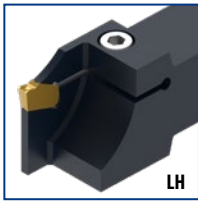

CLCBR
Standard Design

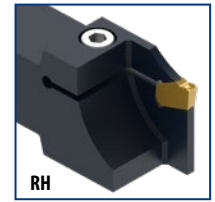

WG380 Ref.	ID-Nr.	pocket size	()	Ø max	h	h1	h2	b	S	L	L1	L2	
CLCBL 1010 K20	10290	SD2	L	28	10	10	10	10	2,2	125	26	36	11
CLCBL 1212 K20	10292	SD2	L	28	12	12	8	12	2,2	125	26	33	11
CLCBL 1612 K20	10298	SD2	L	28	16	16	4	12	2,2	125	26	31	11
CLCBL 2020 K20	10304	SD2	L	40	20	20	5	20	2,2	125	33	33	5
CLCBL 2525 M20	10316	SD2	L	40	25	25	0	25	2,2	150	36	-	2
CLCBL 1212 K30	10294	SD3	L	34	12	12	8	12	3,0	125	29	33	11
CLCBL 1612 K30	10300	SD3	L	34	16	16	4	12	3,0	125	29	34	11
CLCBL 2020 K30	10306	SD3	L	40	20	20	5	20	3,0	125	33	33	5
CLCBL 2525 M30	10318	SD3	L	40	25	25	0	25	3,0	150	36	-	2
CLCBL 1612 K40	10302	SD4	L	40	16	16	8	12	4,0	125	33	34	11
CLCBL 2020 K40	10308	SD4	L	53	20	20	5	20	4,0	125	40	40	5
CLCBL 2525 M40	10320	SD4	L	53	25	25	0	25	4,0	150	40	-	2
CLCBL 2525 P50	10322	SD5	L	80	25	25	15	25	5,0	170	56	62	2
CLCBR 1010 K20	10289	SD2	R	28	10	10	10	10	2,2	125	26	36	11
CLCBR 1212 K20	10291	SD2	R	28	12	12	8	12	2,2	125	26	33	11
CLCBR 1612 K20	10297	SD2	R	28	16	16	4	12	2,2	125	26	31	11
CLCBR 2020 K20	10303	SD2	R	40	20	20	5	20	2,2	125	33	33	5
CLCBR 2525 M20	10315	SD2	R	40	25	25	0	25	2,2	150	36	-	2
CLCBR 1212 K30	10293	SD3	R	34	12	12	8	12	3,0	125	29	33	11
CLCBR 1612 K30	10299	SD3	R	34	16	16	4	12	3,0	125	29	34	11
CLCBR 2020 K30	10305	SD3	R	40	20	20	5	20	3,0	125	33	33	5
CLCBR 2525 M30	10317	SD3	R	40	25	25	0	25	3,0	150	36	-	2
CLCBR 1612 K40	10301	SD4	R	40	16	16	8	12	4,0	125	33	34	11
CLCBR 2020 K40	10307	SD4	R	53	20	20	5	20	4,0	125	40	40	5
CLCBR 2525 M40	10319	SD4	R	53	25	25	0	25	4,0	150	40	-	2
CLCBR 2525 P50	10321	SD5	R	80	25	25	15	25	5,0	170	56	62	2

Fitting inserts

- Torque p. 226, 227, 252
- Tech. Section p. 229
- pocket size p. 230
- p. 176-178

Reinforced parting off holders

CLCBL..X
Standard Design

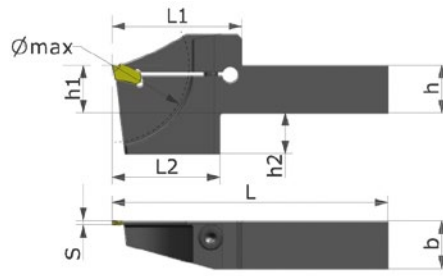
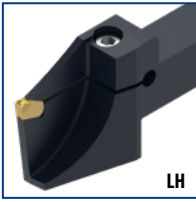

CLCBR..X
Standard Design

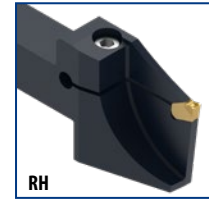

WG380 Ref.	ID-Nr.	pocket size	↻	Ø max	h	h1	h2	b	S	L	L1	L2	
CLCBL 2020 X20 65	10310	SD2	L	65	20	20	17	20	2,2	115	54	45	12
CLCBL 2020 X30 65	10312	SD3	L	65	20	20	17	20	3,0	115	54	45	12
CLCBL 2525 X30 65	10324	SD3	L	65	25	25	12	25	3,0	140	54	45	12
CLCBL 2020 X40 65	10314	SD4	L	65	20	20	17	20	4,0	115	54	45	12
CLCBL 2525 X40 65	10326	SD4	L	65	25	25	12	25	4,0	140	54	45	12
CLCBR 2020 X20 65	10309	SD2	R	65	20	20	17	20	2,2	115	54	45	12
CLCBR 2020 X30 65	10311	SD3	R	65	20	20	17	20	3,0	115	54	45	12
CLCBR 2525 X30 65	10323	SD3	R	65	25	25	12	25	3,0	140	54	45	12
CLCBR 2020 X40 65	10313	SD4	R	65	20	20	17	20	4,0	115	54	45	12
CLCBR 2525 X40 65	10325	SD4	R	65	25	25	12	25	4,0	140	54	45	12

Fitting inserts



Torque
p. 226, 227, 252



Tech. Section
p. 229



pocket size
p. 230





p. 176-178

Parting off blades with autolock pocket

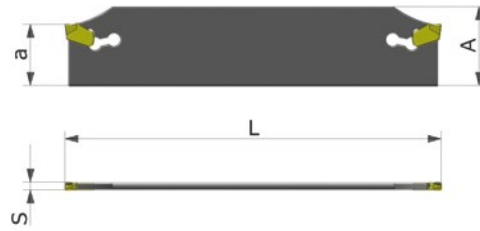
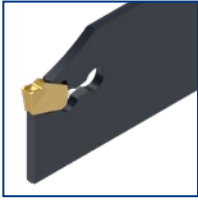



TMS
Standard Design



WG310 Ref.	ID-Nr.	pocket size	(C)	A	a	S	L	
TMS 26 2	10016	SD2	N	26	21,4	2,2	110	16
TMS 26 3	10017	SD3	N	26	21,4	3,0	110	16
TMS 26 4	10018	SD4	N	26	21,4	4,0	110	16
TMS 32 3	10019	SD3	N	32	25,0	3,0	150	16
TMS 32 4	10020	SD4	N	32	25,0	4,0	150	16
TMS 32 5	10021	SD5	N	32	25,0	5,0	150	16
TMS 32 6	10022	SD6	N	32	25,0	6,0	150	16

 Key 1856 (Spare part 16) is added to the delievery. 

Fitting inserts and tool blocks

 Tech. Section	 pocket size	 p. 176-178	 p. 182, 183
--	--	---	--

Tool blocks for parting off blades

TS

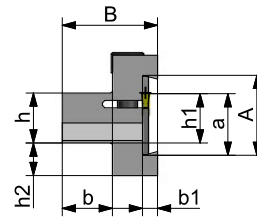
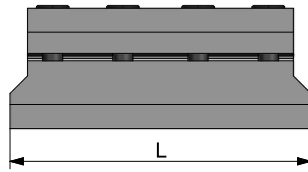

WG330 Ref.	ID-Nr.	()	A	a	h	h1	h2	B	b	b1	L	
TS 26 16	10049	N	26	21,4	16	16	3	34	16	5	90	3
TS 26 20	10050	N	26	21,4	20	20	9	38	20	5	90	3
TS 32 20	10051	N	32	25,0	20	20	13	38	20	6	120	3
TS 32 25	10052	N	32	25,0	25	25	8	38	20	6	120	3
TS 32 32	10053	N	32	25,0	32	32	1	44	25	6	120	3

Remark

Tool blocks KL and TS are recommended for the dovetail shaft tools on [page 101 - 104, 121, 153, 165, 166, 173, 175 and 181](#).

Blades and tool blocks with the same "A" dimension fit together.

Attention! 
Short blade extension will create best results. The shorter the better!

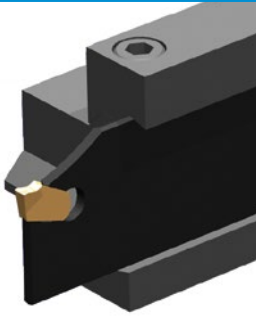

Short extension:

- Clean faces
- No vibrations
- No squeaking
- Best tool life



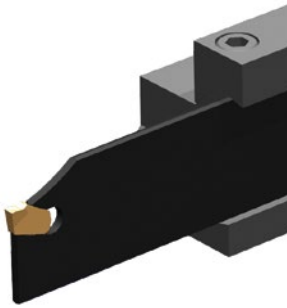

Long extension:

- Rough faces
- Vibrations
- Squeaking
- Low performance





Tool block for parting off blades

KL 52

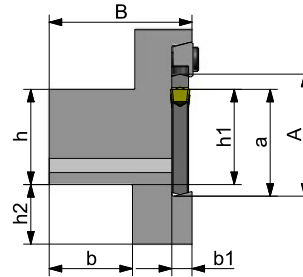
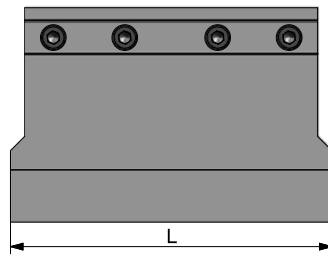
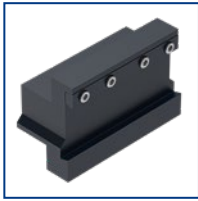

WG330 Ref.	ID-Nr.	(C)	A	a	h	h1	h2	B	b	b1	L	
KL 52 40	45128	N	52,6	45	40	40	25	60	35	8,5	135	2+38
KL 52 50	45129	N	52,6	45	50	50	15	63	38	8,5	135	2+38

Fitting tools

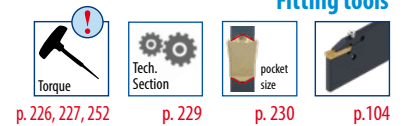

KLV

Height adjustable tool block for parting off blades

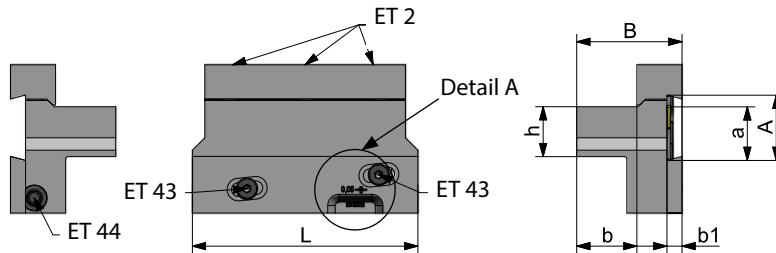
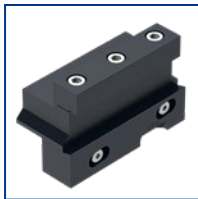

WG330 Ref.	ID-Nr.	(C)	A	a	h	B	b	b1	L	shim plate	
KLV 26 20	10058	N	26	21,4	20	42	24	6	90	-	
KLV 32 20	10059	N	32	25,0	20	42	24	6	120	-	2+43+44
KLV 32 25	10060	N	32	25,0	20	42	24	6	120	X	
shim plate 20x5x120	54556		-	-	5	-	20	-	120	-	

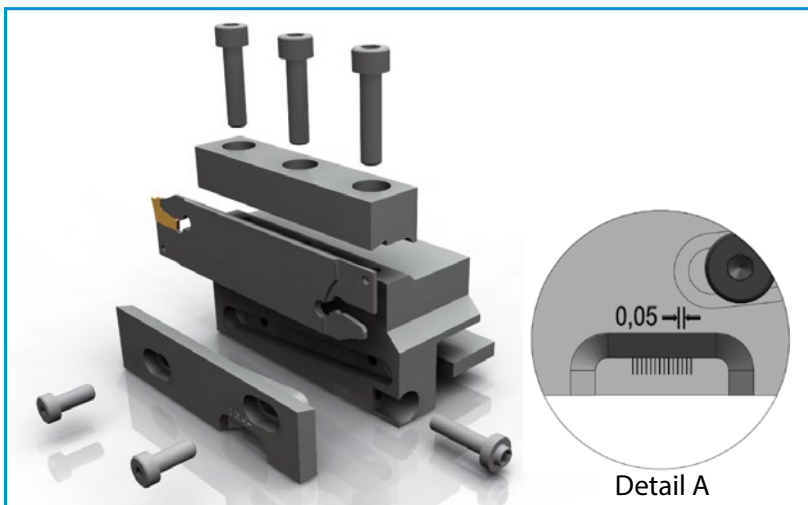

Delivering state of KLV 32-25 corresponds to KLV 32-20.
KLV 32-20 + shim plate 20x5x120.

Fitting tools



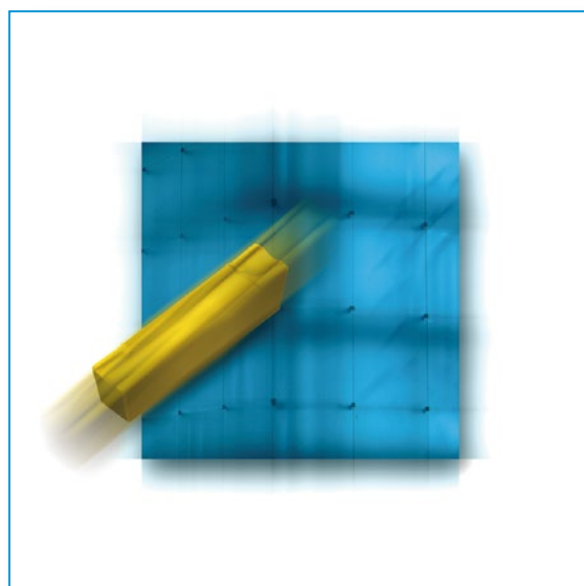
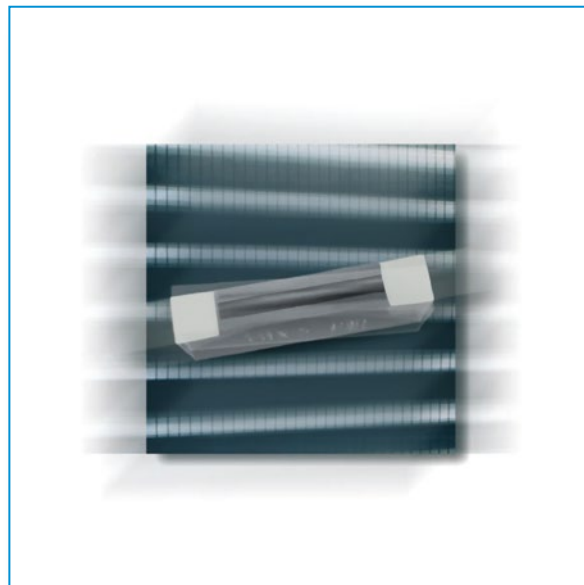
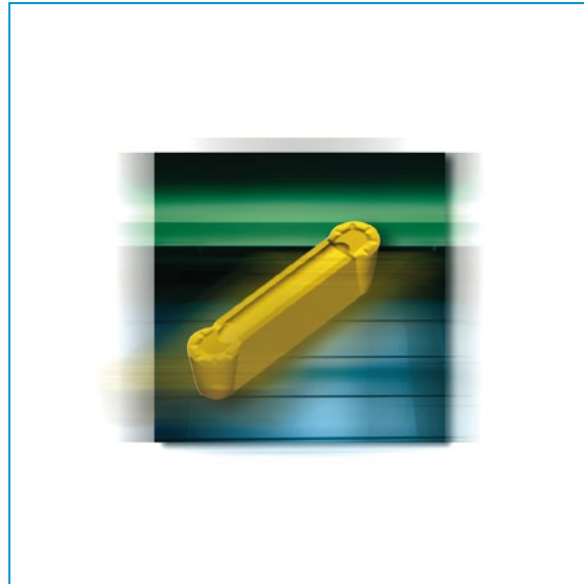

GLM - GripLock Modular

Quick change tool system



GLM - GripLock Modular

Quick change tool system

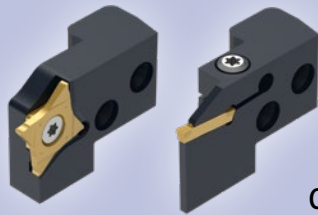

With an **ingenious** interlock the complete GripLock world can be applied to the most advanced, state-of-the-art, clamping system.

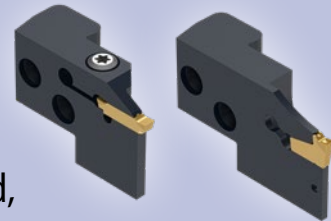

This brilliant engineering achievement saves resources and takes care of our environment.

- ▶ A cleverly constructed interlock-face makes single handed assembly possible.

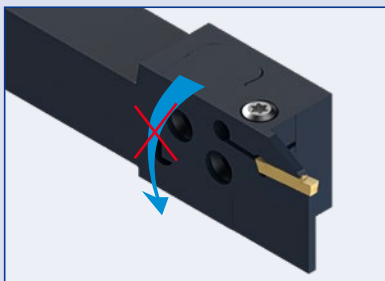

- ▶ The perfect interlock creates monoblock stability.

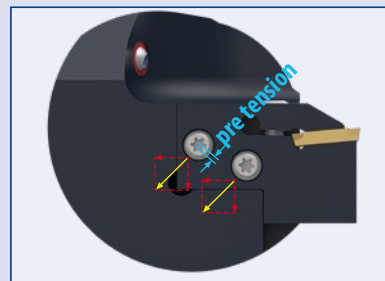

- ▶ Change of cartridges: simple, safe and fast! One key fits all three screws!

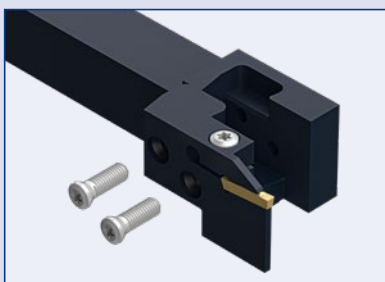

- ▶ All important information at a glance: The type of cartridge, cutting width, NC-Parameter, ID-No. and ISO- drawing.



GLM - GripLock Modular

Quick change tool system

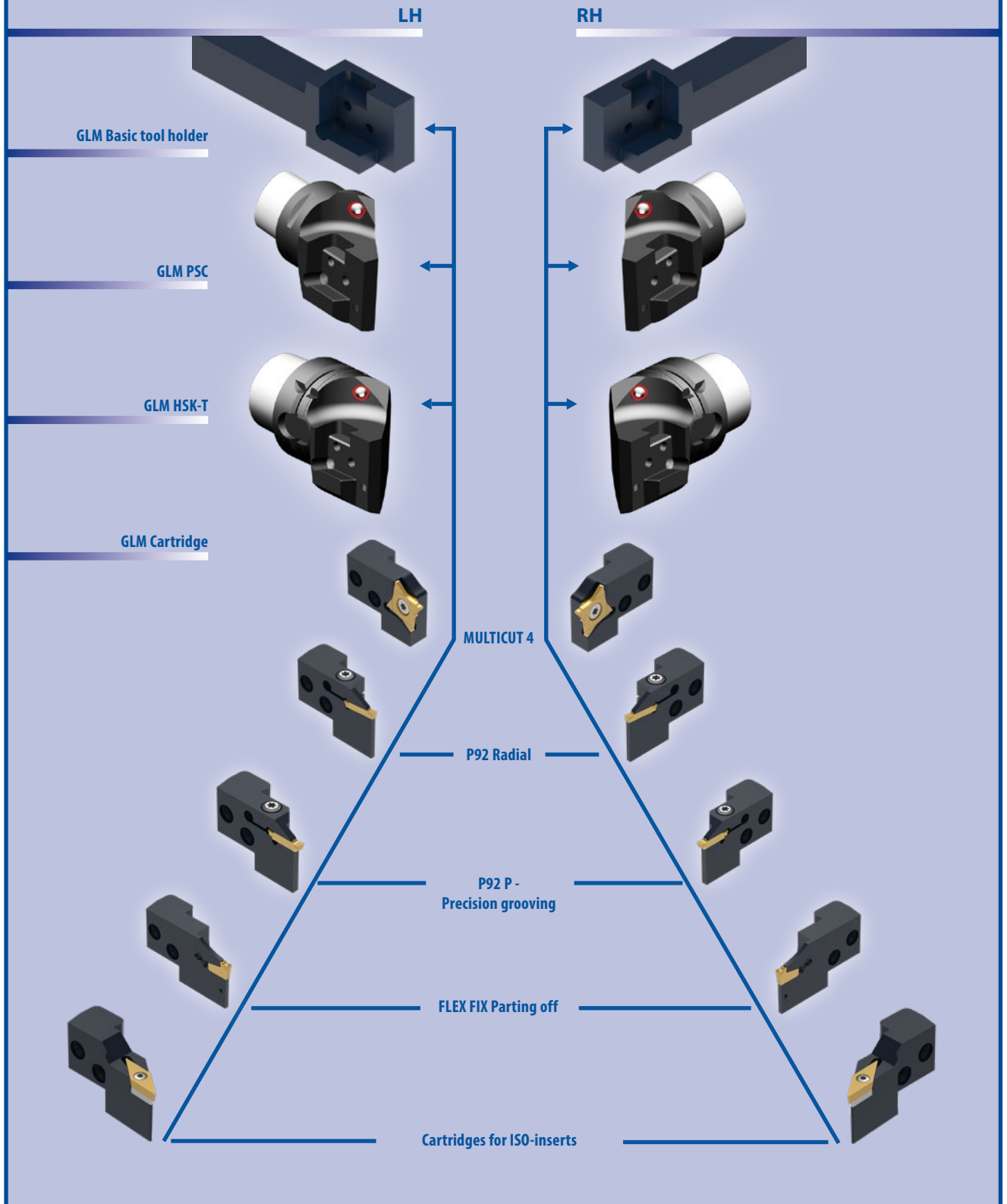

Basic tool holders with interchangeable cartridges

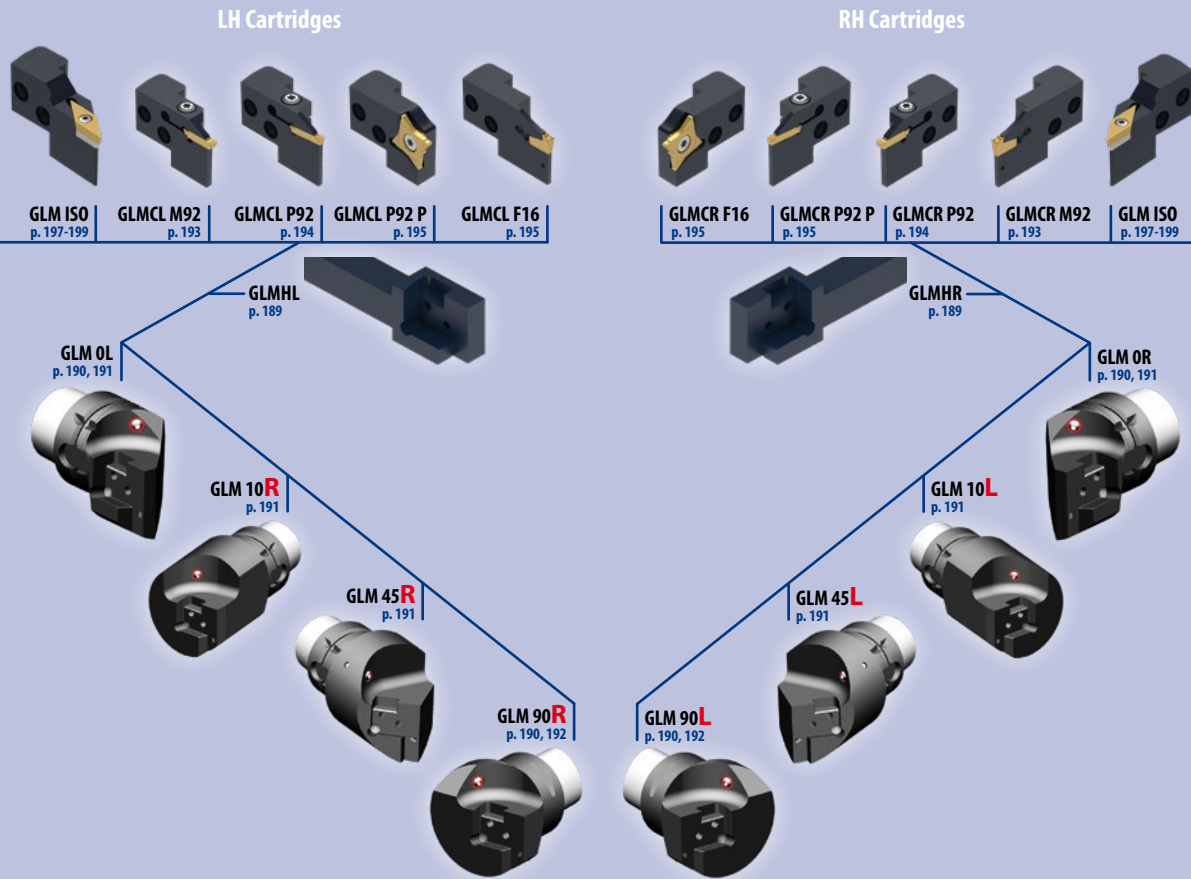

Examples for application and how to fit tools together correctly

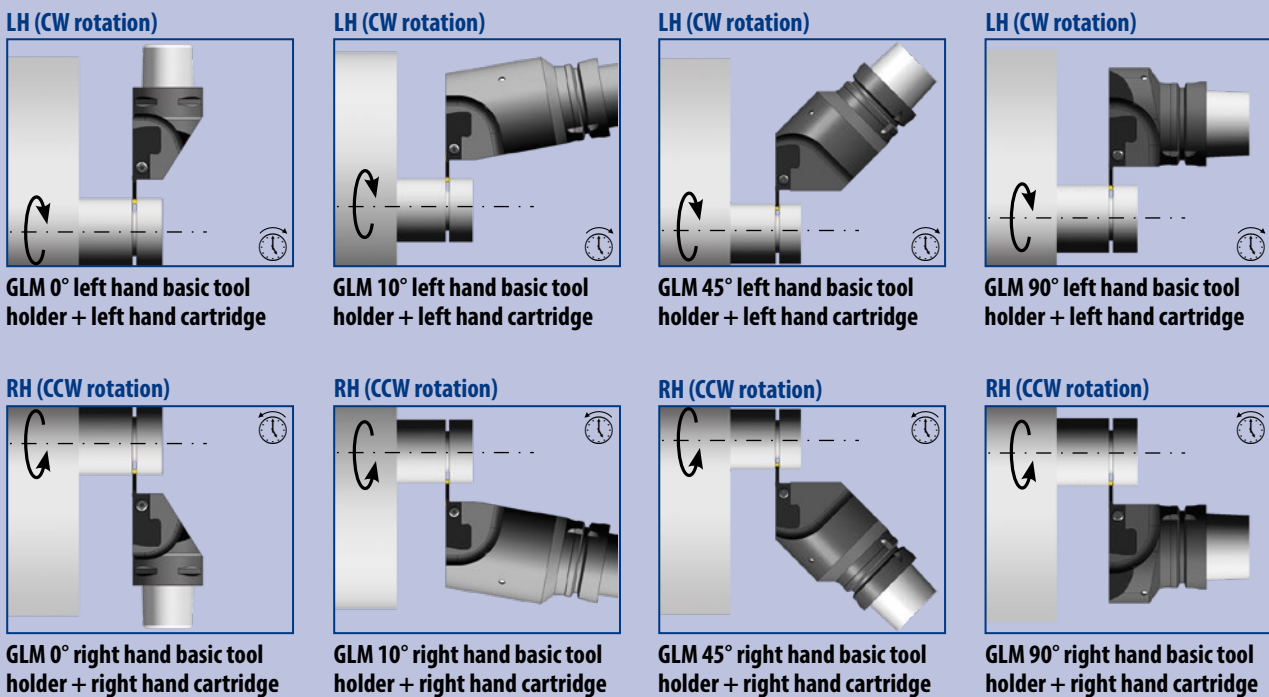

Designation Code for GLM - Basic tool holders

GLM H R 2020



Designation Code for GLM - PSC and HSK-T

GLM PSC 40 R 0 10 70

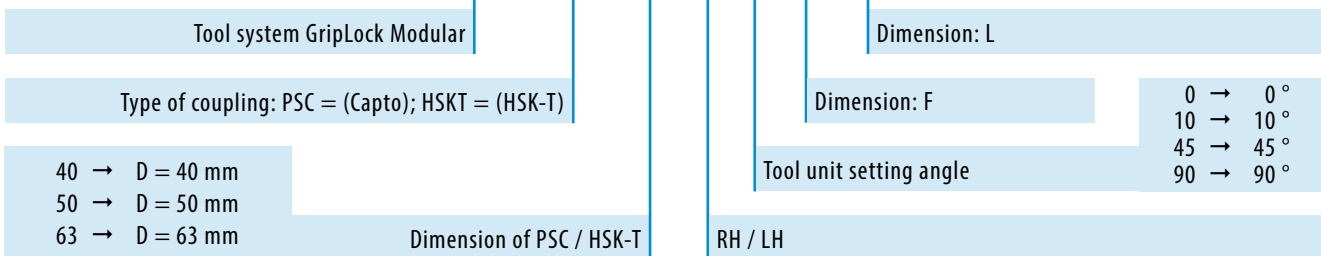

GLM - basic tool holder

GLM H L

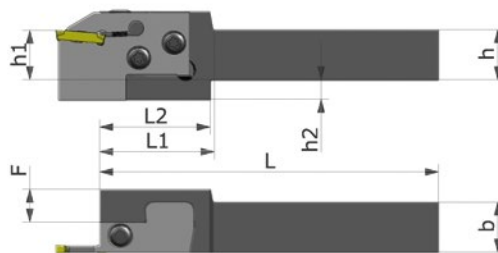
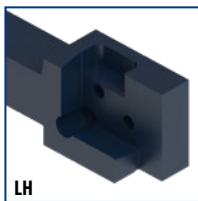

GLM H R

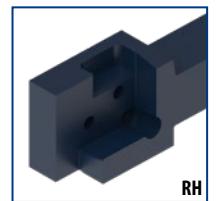

WG501 Ref.	ID-Nr.	()	h	h1	h2	b	L	L1	L2	F	
GLMHL 2020	38072	L	20	20	8	20	130	45	44	8	29
GLMHL 2525	38073	L	25	25	3	25	130	45	44	13	29
GLMHL 3225	38074	L	32	32	0	25	140	40	0	13	29
GLMHR 2020	38069	R	20	20	8	20	130	45	44	8	29
GLMHR 2525	38070	R	25	25	3	25	130	45	44	13	29
GLMHR 3225	38071	R	32	32	0	25	140	40	0	13	29

Fitting cartridges

p. 226, 227, 252	p. 229	p. 230	p. 193	p. 194	p. 195	p. 195-196	p. 197-199

GLM - PSC

GLM PSC 0 L

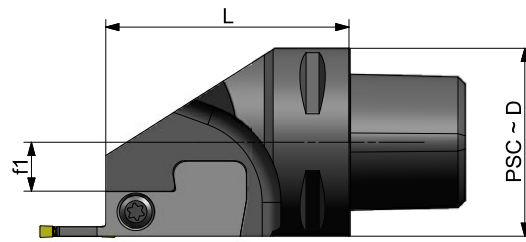

GLM PSC 0 R



WG501 Ref.	ID-Nr.	()	D	PSC	f1	L		Kg
GLM PSC40 L 0 12 65	38078	L	40	40	12,0	65	29	0,59
GLM PSC50 L 0 13 65	38079	L	50	50	13,0	65	29	0,82
GLM PSC63 L 0 195 70	38080	L	63	63	19,5	70	29	1,37
GLM PSC40 R 0 12 65	38075	R	40	40	12,0	65	29	0,59
GLM PSC50 R 0 13 65	38076	R	50	50	13,0	65	29	0,82
GLM PSC63 R 0 195 70	38077	R	63	63	19,5	70	29	1,37

Fitting cartridges, see below

GLM PSC 90 L

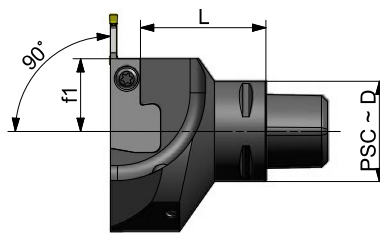

GLM PSC 90 R



WG501 Ref.	ID-Nr.	()	D	PSC	f1	L		Kg
GLM PSC40 L 90 29 50	38090	L	40	40	29,0	50	29	1,04
GLM PSC50 L 90 29 50	38091	L	50	50	29,0	50	29	1,23
GLM PSC63 L 90 315 52	38092	L	63	63	31,5	52	29	1,73
GLM PSC40 R 90 29 50	38087	R	40	40	29,0	50	29	1,04
GLM PSC50 R 90 29 50	38088	R	50	50	29,0	50	29	1,23
GLM PSC63 R 90 315 52	38089	R	63	63	31,5	52	29	1,73

Remark

RH cartridges will fit only on **LH** basic tool holders with setting angles 10°, 45° and 90°. (Assembly for CCW run)

LH cartridges will fit only on **RH** basic tool holders with setting angles 10°, 45° and 90°. (Assembly for CW run)

Fitting cartridges

p. 226, 227, 252	p. 229	p. 230	p. 193	p. 194	p. 195	p. 195-196	p. 197-199

GLM - HSKT

GLM HSKT 0 L

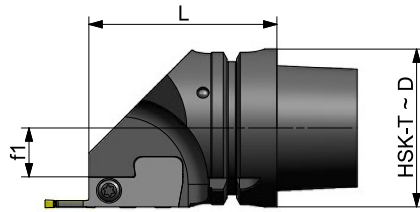

GLM HSKT 0 R



WG501 Ref.	ID-Nr.	(C)	D	HSK-T	f1	L		Kg
GLM HSK63T L 0 195 75	38082	L	63	63	19,5	75	29	1,30
GLM HSK63T R 0 195 75	38081	R	63	63	19,5	75	29	1,30

Fitting cartridges, see below

GLM HSKT 10 L

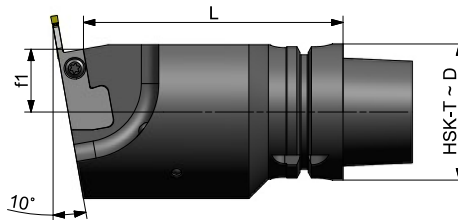

GLM HSKT 10 R



WG501 Ref.	ID-Nr.	(C)	D	HSK-T	f1	L		Kg
GLM HSK63T L 10 29 120	38084	L	63	63	29	120	29	3,56
GLM HSK63T R 10 29 120	38083	R	63	63	29	120	29	3,56

Remark: RH cartridges will fit only on LH basic tool holders with setting angles 10°, 45° and 90°. (Assembly for CCW run)

LH cartridges will fit only on RH basic tool holders with setting angles 10°, 45° and 90°. (Assembly for CW run)

Fitting cartridges, see below

GLM HSKT 45 L

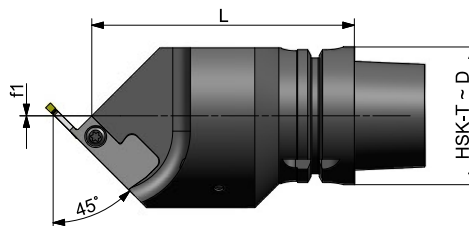

GLM HSKT 45 R



WG501 Ref.	ID-Nr.	(C)	D	HSK-T	f1	L		Kg
GLM HSK63T L 45 00 120	38086	L	63	63	00	120	29	3,19
GLM HSK63T R 45 00 120	38085	R	63	63	00	120	29	3,19

Remark: RH cartridges will fit only on LH basic tool holders with setting angles 10°, 45° and 90°. (Assembly for CCW run)

LH cartridges will fit only on RH basic tool holders with setting angles 10°, 45° and 90°. (Assembly for CW run)

Fitting cartridges

p. 226, 227, 252	p. 229	p. 230	p. 193	p. 194	p. 195	p. 195-196	p. 197-199

GLM - HSKT

GLM HSKT 90 L

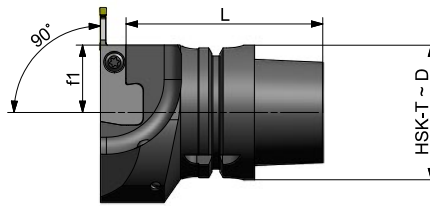

GLM HSKT 90 R



WG501 Ref.	ID-Nr.	↻	D	HSK-T	f1	L		Kg
GLM HSK63T L 90 315 60	38094	L	63	63	31,5	60	29	1,71
GLM HSK63T R 90 315 60	38093	R	63	63	31,5	60	29	1,71

Remark

RH cartridges will fit only on **LH** basic tool holders with setting angles 10°, 45° and 90°. (Assembly for CCW run)

LH cartridges will fit only on **RH** basic tool holders with setting angles 10°, 45° and 90°. (Assembly for CW run)

Torque
p. 226, 227, 252

Tech. Section
p. 229

pocket size
p. 230

p. 193

p. 194

p. 195

p. 195-196

p. 197-199

Fitting cartridges

Cooling flow unit and key

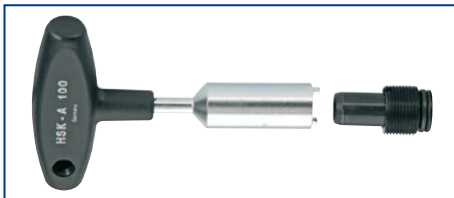

WG355 Holder	Cooling flow unit ID-Nr	Key ID-Nr.
HSK63T	38834	38833

Remark

This sealing unit stops coolant flowing through the spindle and prevents bearings from being damaged.

Designation Code for GLM - cartridges

GLM C R P92 30 17

Tool family GripLock Modular		Cutting depth
Cartridge	RH / LH	Cutting width
	Tool system (Applied inserts)	P92 → Cutting P92 P → Precision grooving M92 Q → MULTICUT F16 → Flex Fix

GLM - Cartridges

GLMCL M92 Q

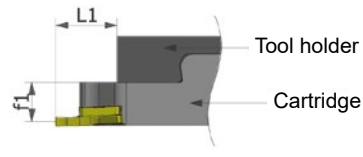
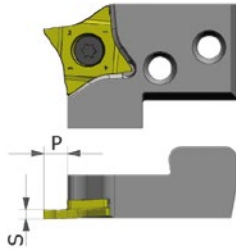
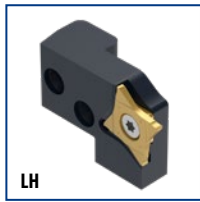

GLMCR M92 Q

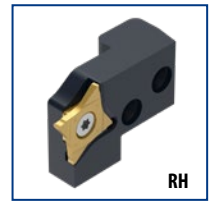

WG510 Ref.	ID-Nr.	pocket size	()	P	L1	f1	
GLMCL M92 Q 16 65	38182	16	L	6,5	17,5	12,3	24
GLMCR M92 Q 16 65	38179	16	R	6,5	17,5	12,3	24

Fitting inserts, see below

GLM Cartridge system M92 with internal cooling

GLMCL M92Q...HP System

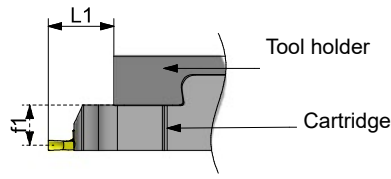
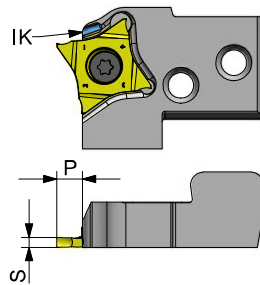

GLMCR M92Q...HP System

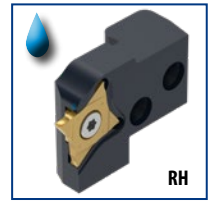

WG5105 Ref.	ID-Nr.	pocket size	()	P	L1	S	f1	
GLMCL M92 Q 16 65 HP	59914	16	L	6,5	17,5	0,5 - 3,5	12,3	24
GLMCR M92 Q 16 65 HP	49703	16	R	6,5	17,5	0,5 - 3,5	12,3	24

Fitting inserts and tools

p. 226, 227, 252	p. 229	p. 230	p. 29 + 30	p. 31	p. 32	p. 33	p. 34	p. 35-37	p. 52	p. 189	p. 191-192	p. 83-86

GLM Cartridge system P92

GLMCL P92

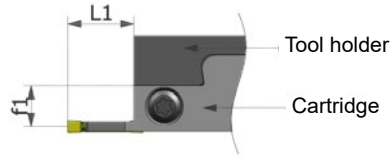
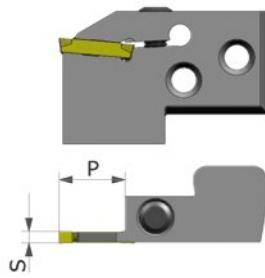
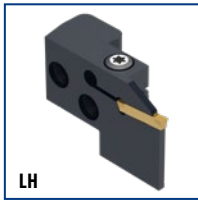

GLMCR P92

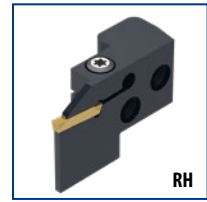

WG510 Ref.	ID-Nr.	pocket size	(C)	P	L1	S	f1	
GLMCL P92 20+25 17	38107	20	L	17	17,5	2+2,5	11,20	29
GLMCL P92 30 17	38108	30	L	17	17,5	3	10,76	29
GLMCL P92 40 17	38109	40	L	17	17,5	4	10,26	29
GLMCL P92 50 22	38110	50	L	22	22,5	5	9,86	29
GLMCR P92 20+25 17	38097	20	R	17	17,5	2+2,5	11,20	29
GLMCR P92 30 17	38098	30	R	17	17,5	3	10,76	29
GLMCR P92 40 17	38099	40	R	17	17,5	4	10,26	29
GLMCR P92 50 22	38100	50	R	22	22,5	5	9,86	29

Fitting inserts and tools, see below

GLM Cartridge system P92 with internal cooling

GLMCL P92...HP System

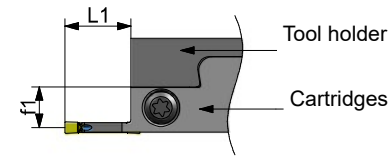
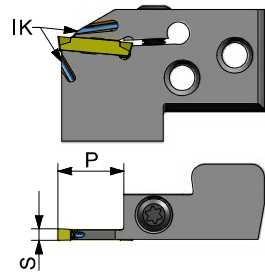

GLMCR P92...HP System



WG5105 Ref.	ID-Nr.	pocket size	(C)	P	L1	S	f1	
GLMCL P92 30 17 HP	59916	30	L	17	17,5	3	10,76	29
GLMCR P92 30 17 HP	59917	30	R	17	17,5	3	10,76	29

How to write an order: **recommended**

1 pc. GLM HSK63T R 0 195 75 or: **1 pc. ID-Nr. 38081**

1 pc. GLMCR P92 30 17 or: **1 pc. ID-Nr. 38098**

Fitting inserts and tools

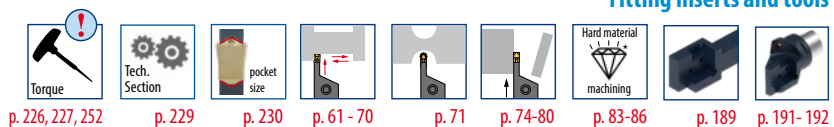

GLM - Cartridge system P92 P

GLMCL P92 P

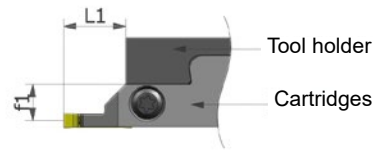
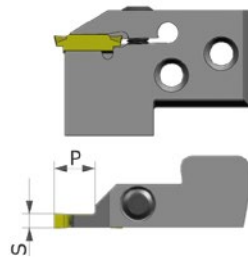
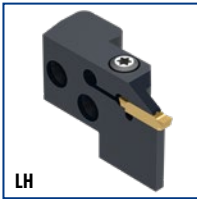

GLMCR P92 P

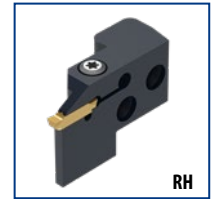

WG510 Ref.	ID-Nr.	Plattensitzgröße	(↻)	P	L1	S	f1	
GLMCL P92 P 4 11	38175	P40	L	11	17,5	4	10,26	29
GLMCL P92 P 5+6 14	38176	P50	L	14	20,5	5+6,5	9,86	29
GLMCR P92 P 4 11	38171	P40	R	11	17,5	4	10,26	29
GLMCR P92 P 5+6 14	38172	P50	R	14	20,5	5+6,5	9,86	29

Fitting inserts and tools

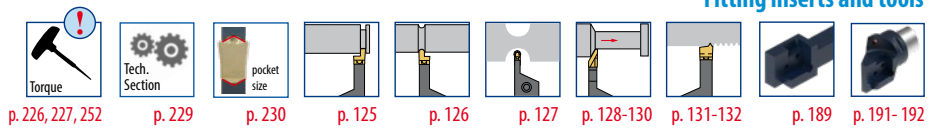

GLM - Cartridge system F16

GLMCL F16

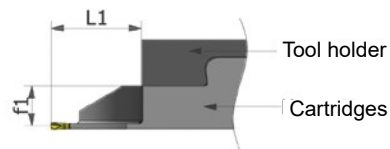
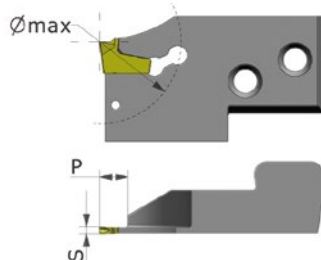
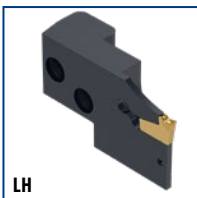

GLMCR F16

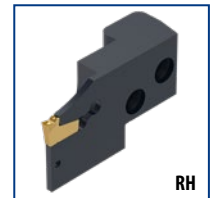

WG510 Ref.	ID-Nr.	pocket size	(↻)	P1	L1	Ø max	S	f1	
GLMCL F16 20 50	43338	FF2	L	6,0	25,5	50	2	11,2	AWF16
GLMCL F16 30 50	38880	FF3	L	6,0	25,5	50	3	10,8	AWF16
GLMCL F16 40 50	43339	FF4	L	6,0	25,5	50	4	10,3	AWF16
GLMCR F16 20 50	43340	FF2	R	6,0	25,5	50	2	11,2	AWF16
GLMCR F16 30 50	39726	FF3	R	6,0	25,5	50	3	10,8	AWF16
GLMCR F16 40 50	43341	FF4	R	6,0	25,5	50	4	10,3	AWF16

Fitting inserts and tools

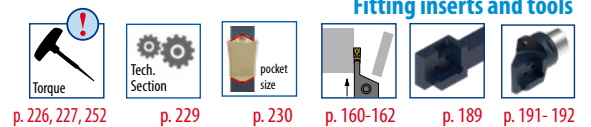

GLM Cartridge system F16 with internal cooling

GLM CL F16...HP
System

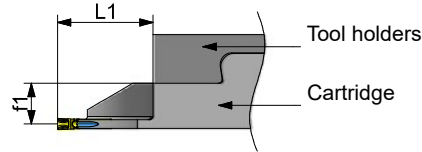
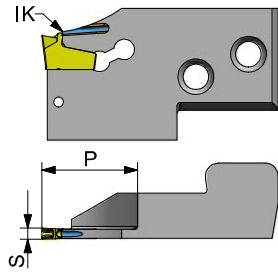

GLM CR F16...HP
System

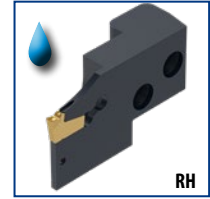

WG5105 Ref.	ID-Nr.	pocket size	(C)	P1	L1	Ø max	S	f1	
GLMCL F16 30 50 HP	59918	FF3	L	6,0	25,5	50	3	10,8	AWF16
GLMCR F16 30 50 HP	59919	FF3	R	6,0	25,5	50	3	10,8	AWF16

Fitting inserts and tools

- Torque: p. 226, 227, 252
- Tech. Section: p. 229
- pocket size: p. 230
- p. 160-162
- p. 189
- p. 191-192

Eject

Lock

FLEX FIX insert changing

easy
safe
quick

Key for FLEX FIX tools



AW F16
FLEX FIX



WG355 Bezeichnung	ID-Nr.	ET
AW F16	39880	AW F16 1
AW F16 1	39881	

Remark: The key is added to each FLEX FIX tool delivery.

The GripLock modular cartridge system now available for ISO inserts

A unique interface

The GripLock modular system fits:

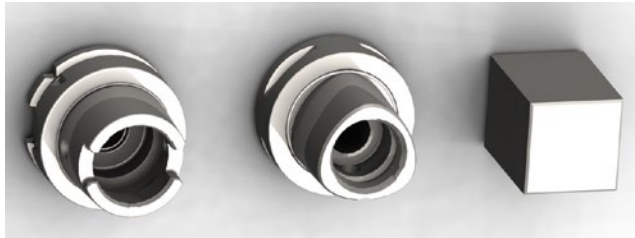

HSK-T

PSC

square

Tailor made ISO cartridges can be ordered

Required information for Specials

- Type of insert
- Right hand or left hand
- Setting angle
- Clamping with spare parts
- Holder/flange type/setting angle of cartridge
- Setting angle of cartridge
- Maximal extension

Designation Code for ISO - cartridges

GLM C R CN 12 04

Tool family GripLock Modular

Insert thickness

Cartridge

Length of cutting edge

RH/LH

Form and clearance of insert

GLM-ISO-Cartridges for ISO threading inserts

GLMCL 16EL ISO

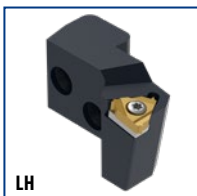

LH

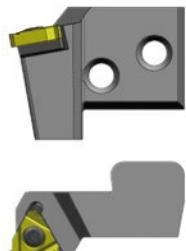

GLMCR 16ER ISO

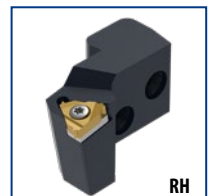

RH

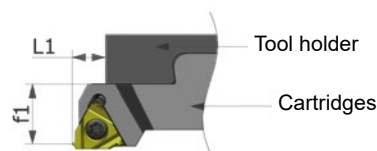

WG550 Ref.	ID-Nr.	()	L1	f1	Insert	
GLMCL 16EL ISO	47680	L	8,8	17	16 EL	
GLMCR 16ER ISO	46962	R	8,8	17	16 ER	

GLM-ISO-cartridges with positive insert pocket

GLMCL CC09T3

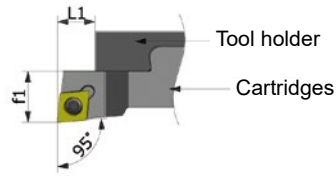
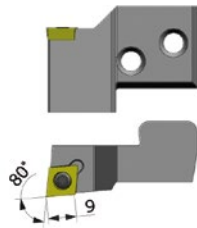
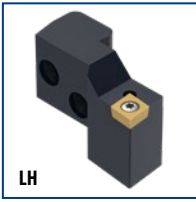

GLMCR CC09T3

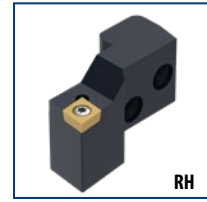

WG550 Ref.	ID-Nr.	(C)	L1	f1	Insert	
GLMCL CC09T3	46966	L	12,5	17	CCGT09T3	
GLMCR CC09T3	46961	R	12,5	17	CCGT09T3	

GLMCL DC11T3

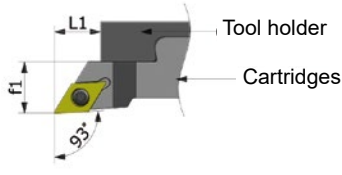
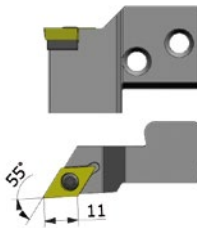
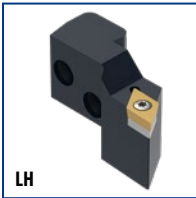

GLMCR DC11T3

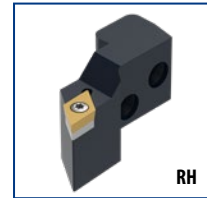

WG550 Ref.	ID-Nr.	(C)	L1	f1	Insert	
GLMCL DC11T3	46959	L	15,5	17	DCGT11T3	
GLMCR DC11T3	46965	R	15,5	17	DCGT11T3	

GLMCL VC1604

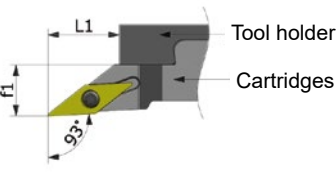
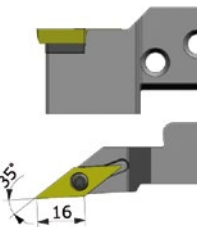
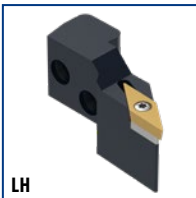

GLMCR VC1604

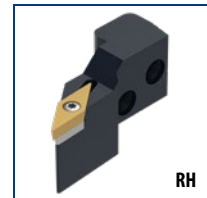

WG550 Ref.	ID-Nr.	(C)	L1	f1	Insert	
GLMCL VC1604	46968	L	24,5	17	VCGT1604	
GLMCR VC1604	46967	R	24,5	17	VCGT1604	

GLMCL VC1303

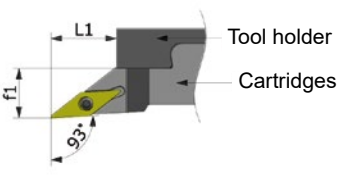
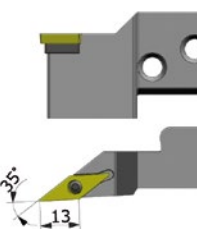
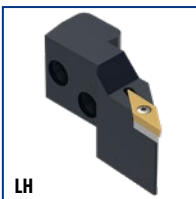

GLMCR VC1303

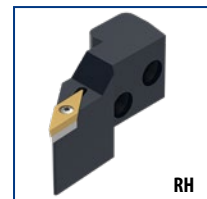

WG550 Ref.	ID-Nr.	(C)	L1	f1	Insert	
GLMCL VC1303	47553	L	22,5	16,5	VCGT1303	
GLMCR VC1303	47554	R	22,5	16,5	VCGT1303	

GLM-ISO-cartridges with negative insert pocket

GLMCL CN1204

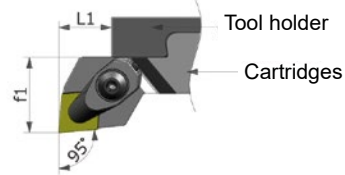
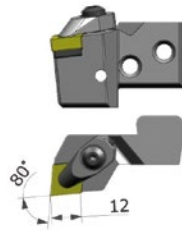
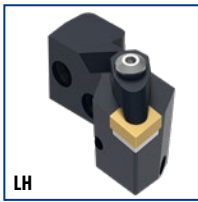

GLMCR CN1204

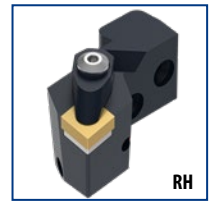

WG550 Ref.	ID-Nr.	()	L1	f1	Insert	
GLMCL CN1204	47607	L	17,5	25	CNMG1204	
GLMCR CN1204	47341	R	17,5	25	CNMG1204	

GLMCL WN0804

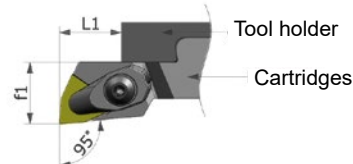
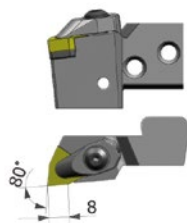

GLMCR WN0804



WG550 Ref.	ID-Nr.	()	L1	f1	Insert	
GLMCL WN0804	46964	L	20,5	20,5	WNMG0804	
GLMCR WN0804	46969	R	20,5	20,5	WNMG0804	

GLMCL VN1604

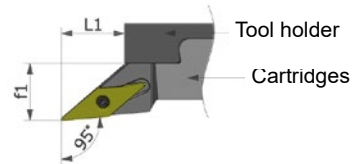
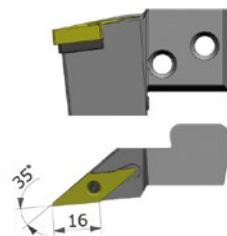
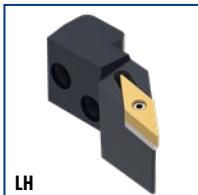

GLMCR VN1604

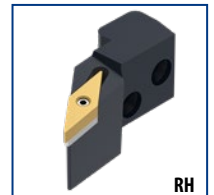

WG550 Ref.	ID-Nr.	()	L1	f1	Insert	
GLMCL VN1604	46960	L	21,5	19	VNMG1604	
GLMCR VN1604	46963	R	21,5	19	VNMG1604	

GLMCL DN1506

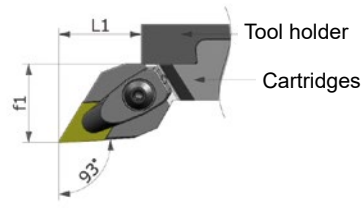
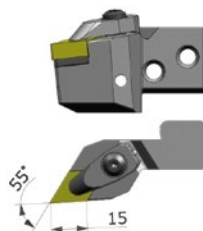

GLMCR DN1506



WG550 Ref.	ID-Nr.	()	L1	f1	Insert	
GLMCL DN1506	47606	L	27,5	26	DNMG1506	
GLMCR DN1506	47340	R	27,5	26	DNMG1506	

GLM - Modular cartridges machining a large component

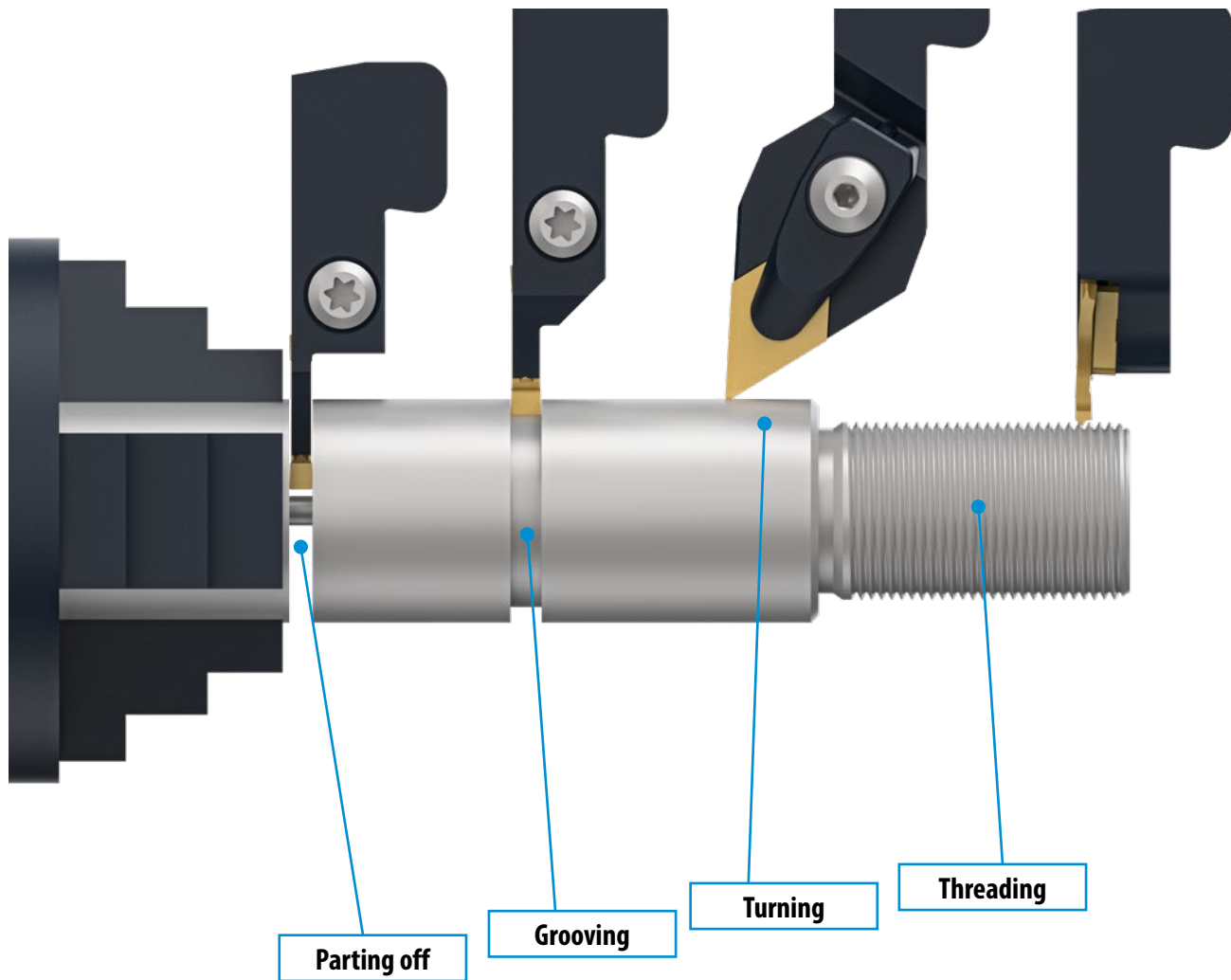

9

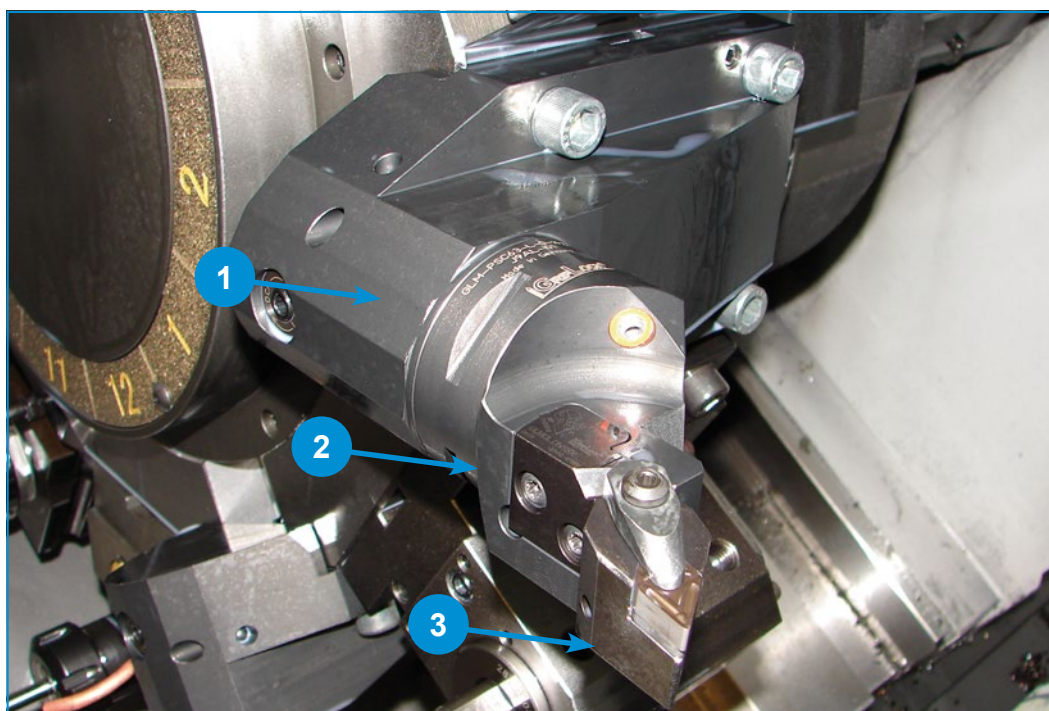

Application on a turret

- 1 PSC Basic holder
- 2 GLMCL PSC63019570
- 3 GLMCL DN1506

GLM - GripLock Modular

perfect tailor made solutions unlimited

Tooling units



Special cartridges for standard basic tool holders

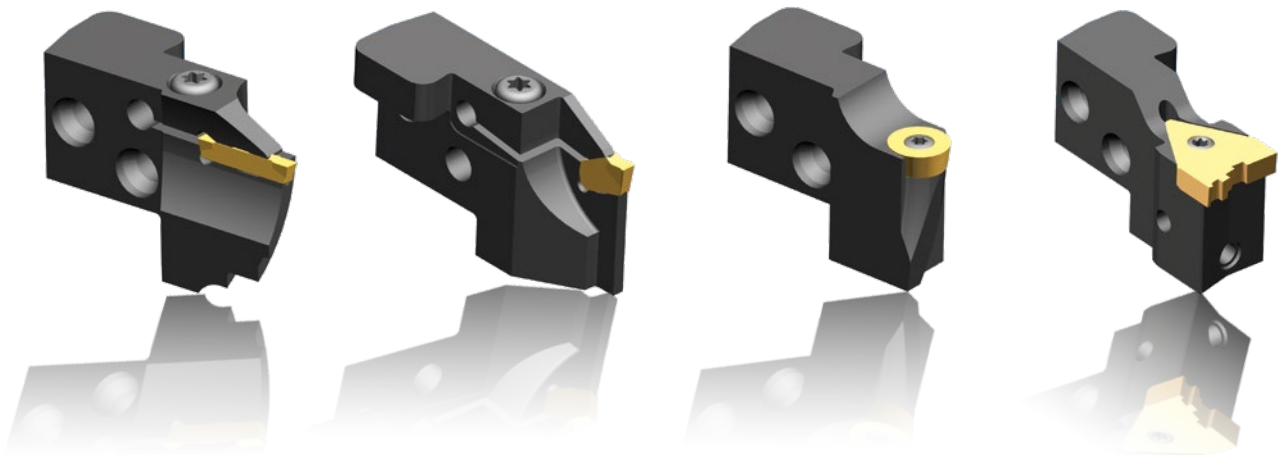

GLM - GripLock Modular

perfect tailor made solutions unlimited

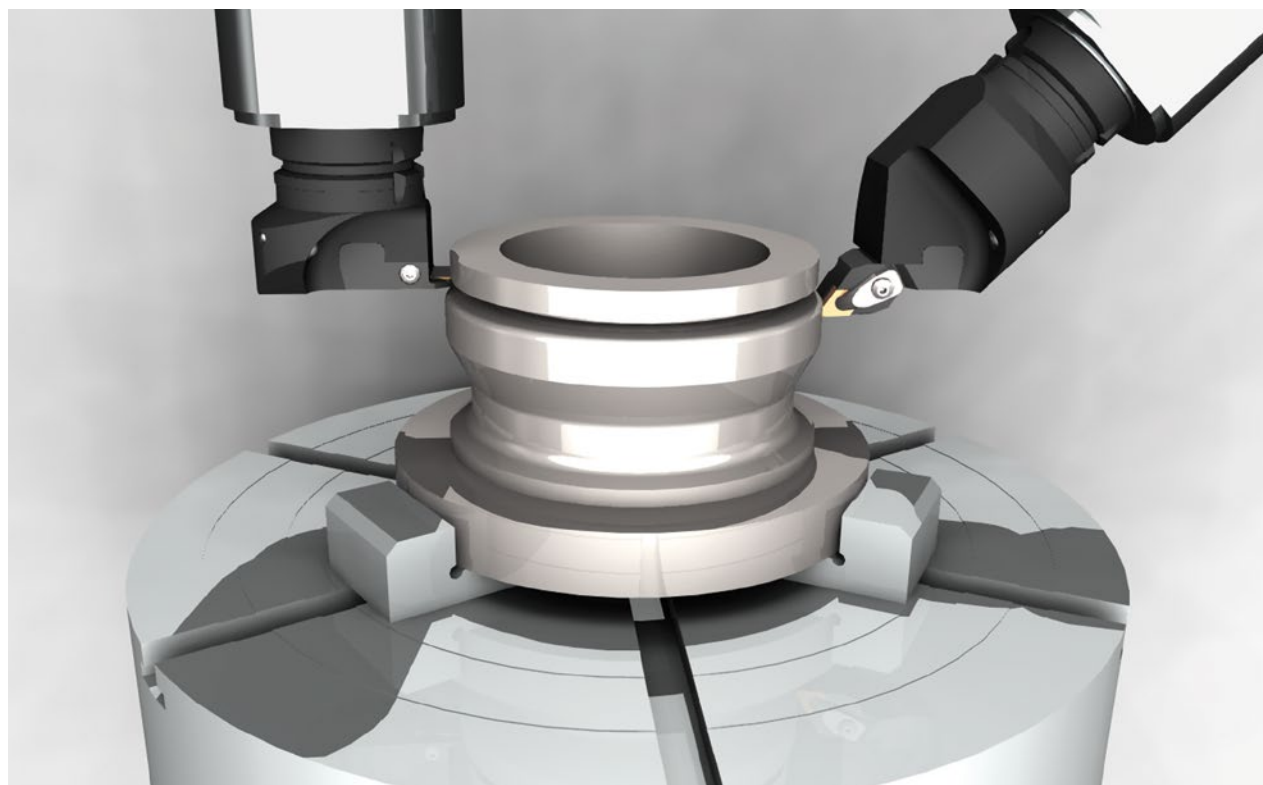

GLM applications for tailor made solutions

SPECIAL *Cartridges*

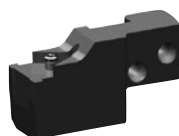

Cutting GripLock or ISO Turning

SPECIAL *Holder*s



e.g. 40 x 50

SPECIAL *Boring bars*

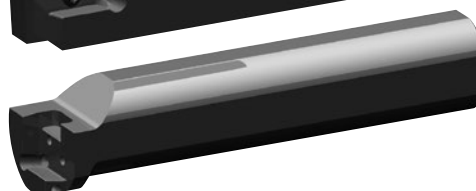

e.g. D 40

SPECIAL *Tool holders*



PSC 32 - 80
(can be delivered as well as
Monoblock tools.)

F92 - Profiling system

Special profiles to customer specifications

- ▶ *Fast production of special profiles*
- ▶ *5 different pre ground blanks*
- ▶ *Perfect interlock between holder and insert*
- ▶ *Excellent price-performance ratio*



F92 - Profiling system

Special profiles to customers specification

**Semi-finished insert
width: 12 mm - 30 mm**

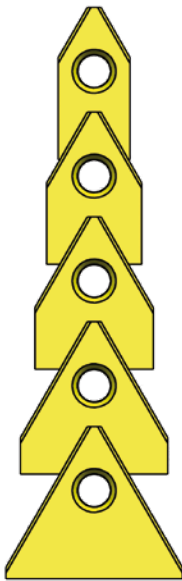

How to place an order:

Example 1: If you intend to grind profiles yourself, you can order tool holders and pre ground inserts.

Example 2: If you give us the order to produce profile inserts, we definitely need

- Complete drawing of the component or the profile with dimensions and tolerances
- Lathe rotation: clockwise or counter clockwise
- Material to be machined
- Required coating (see listing p. 240)
- Planned order quantities of tool holders and inserts
- Required delivery times

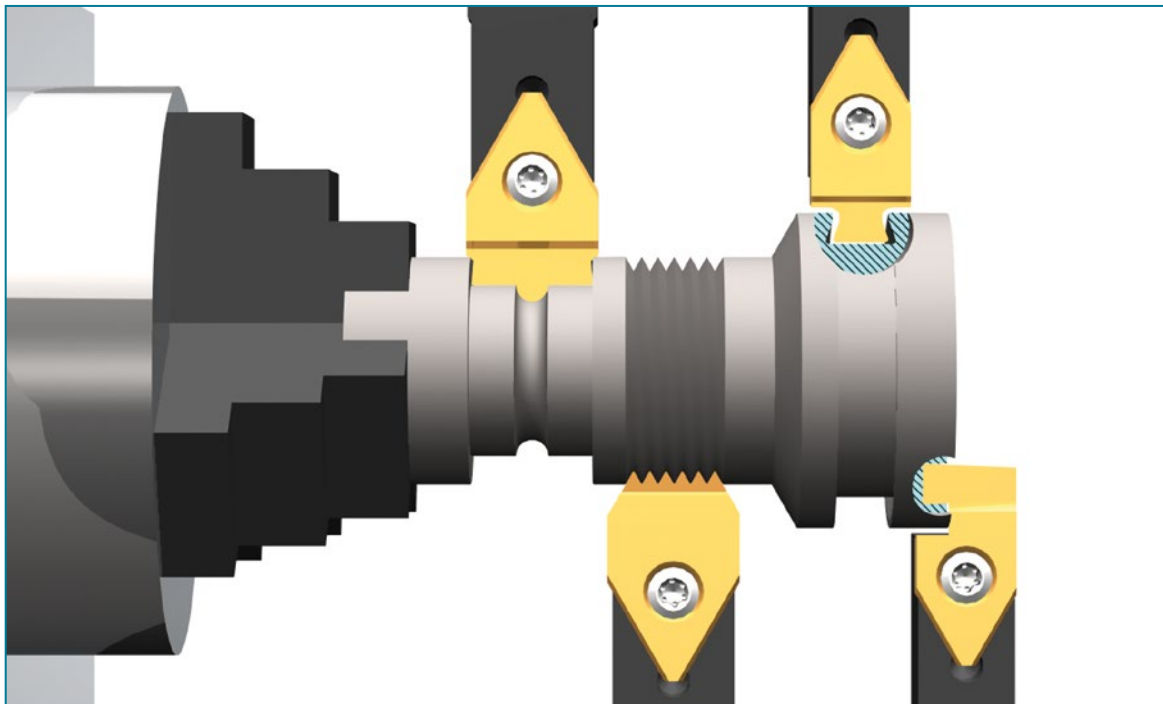

You can see further interesting examples from page 211 onwards.

Designation code for profile inserts

F 00000 16 15 16

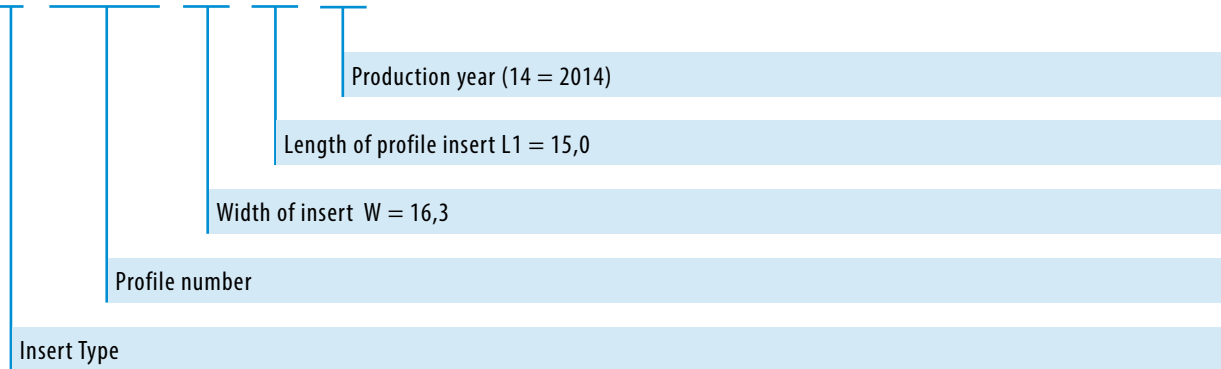

Pre-ground inserts

F 00000...00
System F92

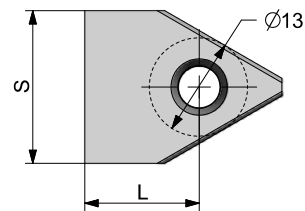
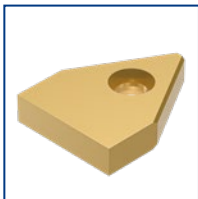

WG998 Ref.	GF 25 ID-Nr.	pocket size	h ±0,10	s ^{+0,2}	L ±0,1
F 00000 12 15 00	29269	F13	5,1	12,3	15,0
F 00000 16 15 00	29272	F13	5,1	16,3	15,0
F 00000 20 15 00	29273	F13	5,1	20,3	15,0
F 00000 25 15 00	29275	F13	5,1	25,3	15,0
F 00000 30 15 00	47291	F13	5,1	30,3	15,0

- Remark** Ground faces:
- Both flat-faces
 - Both pocket faces
 - Chamfer between these faces

The hole has got countersinks on both sides to turn the insert around.



Fitting tools



p. 229



p. 230



p. 206

Designation code of tool holders for profile inserts

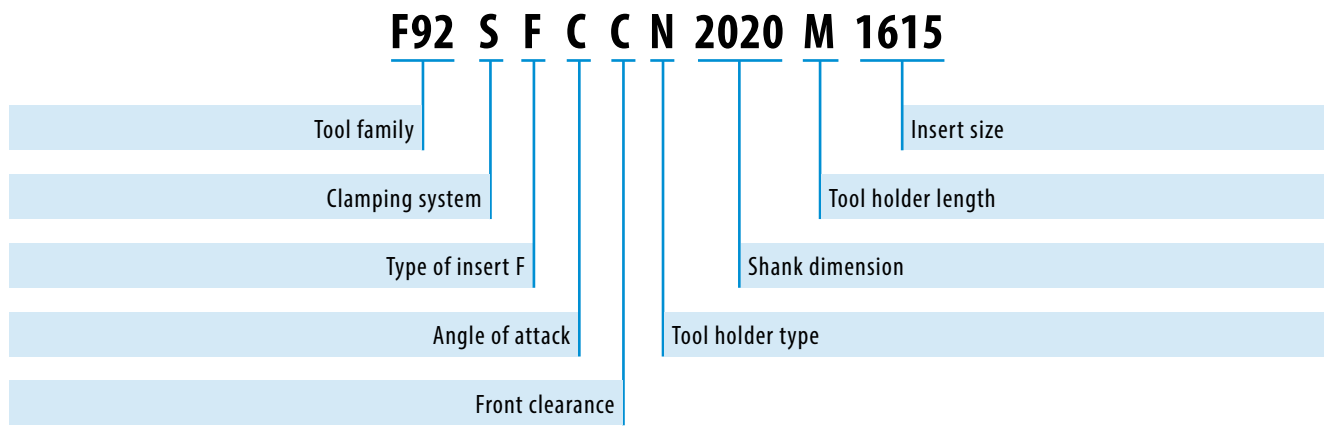

F92 Tool holders for profile inserts

F92 SFCCN
System F92

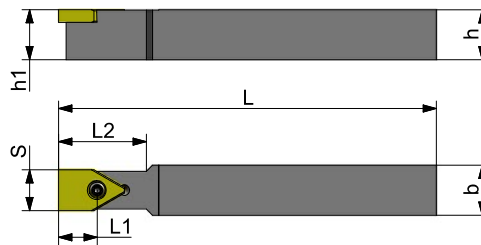
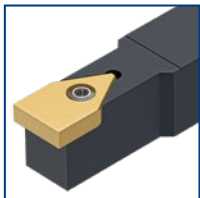

WG360 Ref.	ID-Nr.	pocket size	⌀	h	h1	b	S	L	L1	L2	
F92 SFCCN 1212 K12 15	29265	F13	N	12	12	12	12,0	125	15	35	25
F92 SFCCN 1212 K16 15	29342	F13	N	12	12	12	16,0	125	15	35	25
F92 SFCCN 1616 K12 15	29343	F13	N	16	16	16	12,0	125	15	35	25
F92 SFCCN 1616 K16 15	29266	F13	N	16	16	16	16,0	125	15	35	25
F92 SFCCN 1616 K20 15	29344	F13	N	16	16	16	20,0	125	15	35	25
F92 SFCCN 2020 M12 15	29345	F13	N	20	20	20	12,0	150	15	35	25
F92 SFCCN 2020 M16 15	29346	F13	N	20	20	20	16,0	150	15	35	25
F92 SFCCN 2020 M20 15	29267	F13	N	20	20	20	20,0	150	15	35	25
F92 SFCCN 2525 M16 15	29347	F13	N	25	25	25	16,0	150	15	35	25
F92 SFCCN 2525 M20 15	29348	F13	N	25	25	25	20,0	150	15	35	25
F92 SFCCN 2525 M25+30 15*	29268	F13	N	25	25	25	25,0+30,0	150	15	35	25

* Both inserts fit: F0000251500 and F0000301500

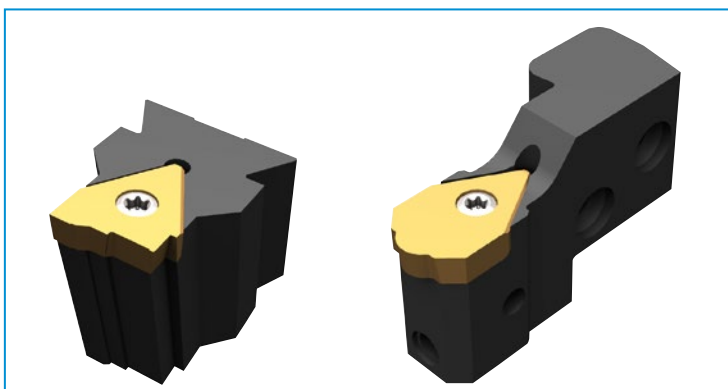

Remark
AWN-28 System and GLM Cartridge System on request.

Fitting inserts

Drehmoment
p. 226, 227, 252

Tech. Section
p. 229

pocket size
p. 230

p. 205

Tailor made solutions

...a real challenge

- ▶ *Special tool holders*
- ▶ *Special inserts*

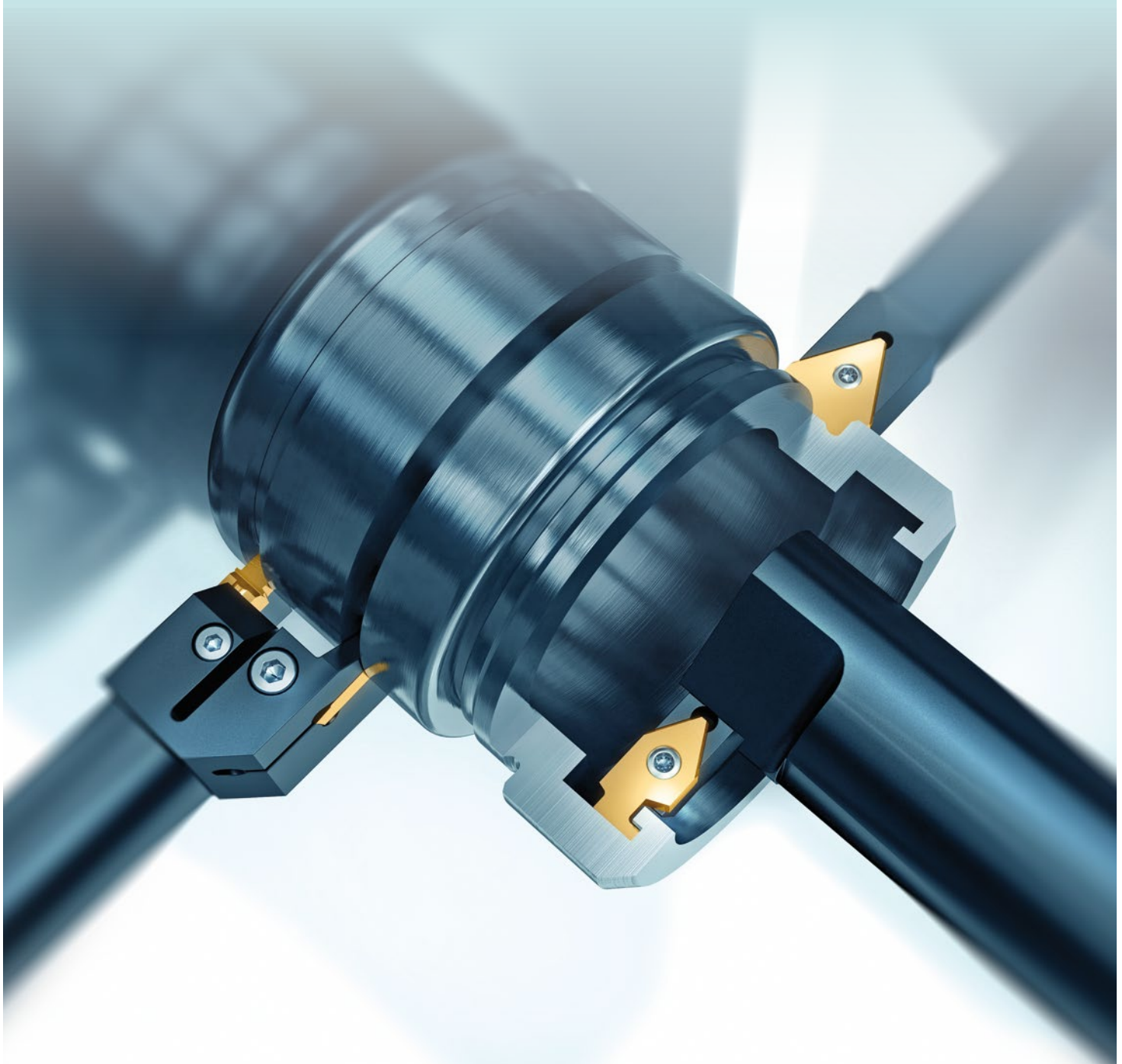
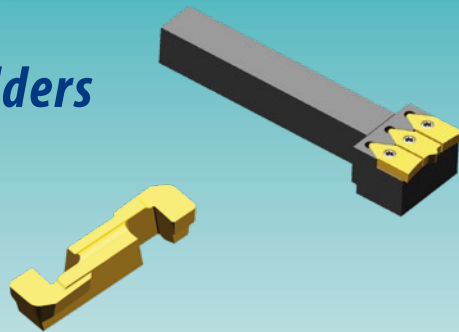

Individual solutions

Why solutions by Kemmer?

Machining operations are continuously improving. That means that manufacturer, service provider and suppliers have to adapt to new challenges. Kemmer is your production and service partner solving these new challenges.



Competent consulting based on long-time experience.



Timely offers containing solutions.



Short delivery times.*



High quality and fair prices.

* Delivery times depend on design, quantities and production time. On your enquiries, you'll receive an individual quotation containing the delivery time.



- Individual
- Profitable
- Fast
- Reliable

... simply perfect!

Tailor made inserts



- ▶ So far more than 3700 different profiles have been ground
- ▶ Manufactured on most advanced machine tools
- ▶ Qualified employees
- ▶ Small quantities can also be made
- ▶ Precise cutting edges (Perfection on the edge)



Tailor made inserts with 2 edges based on P92 and P92-P System

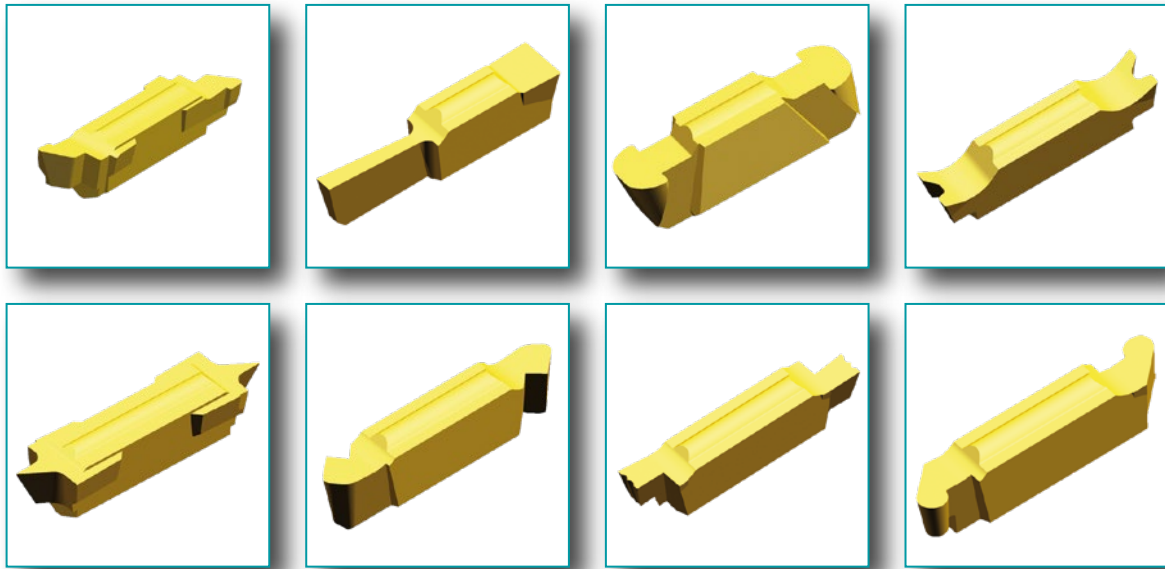

*Special requirements?
We will fulfill them!*

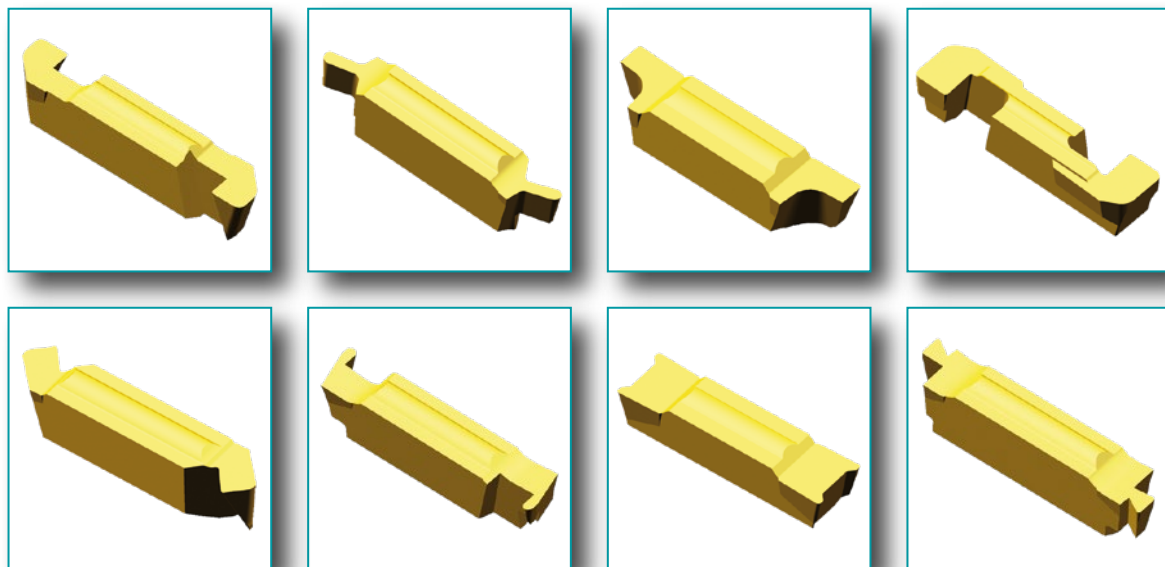

Tailor made insert with 4 edges based on MC4 system

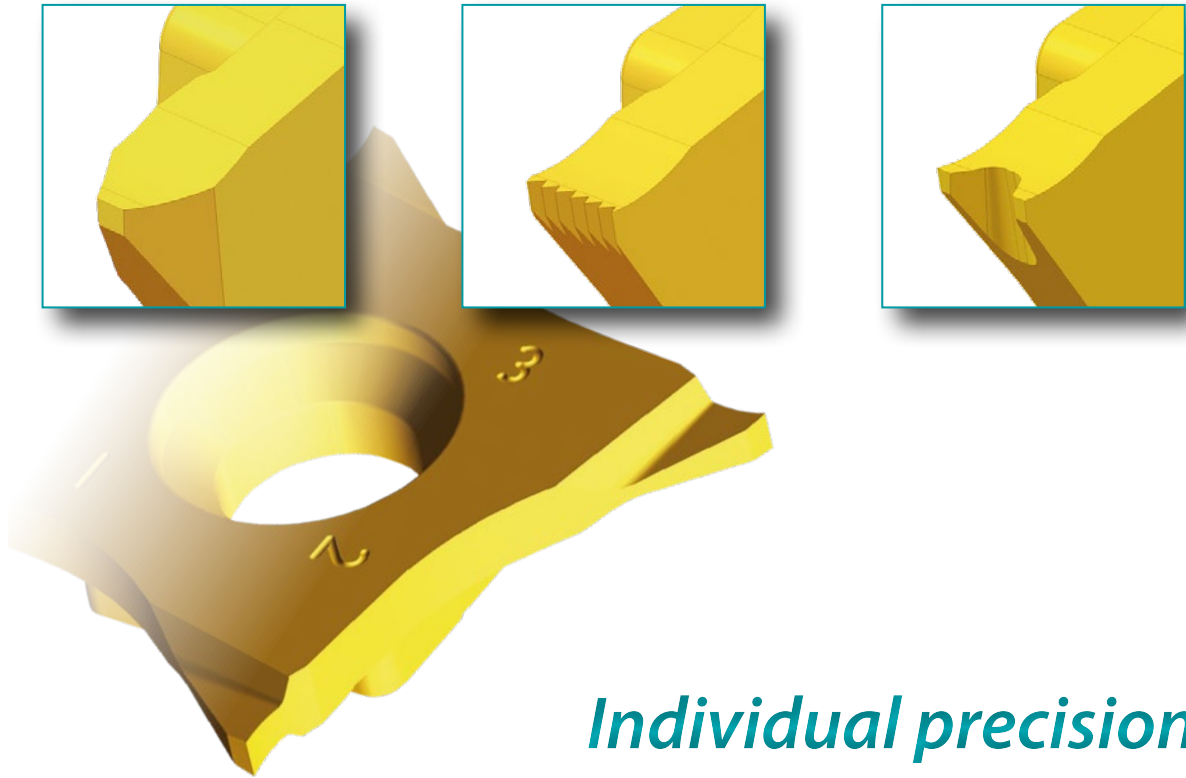

*Individual precision
on each corner*

Profile inserts based on F92 system

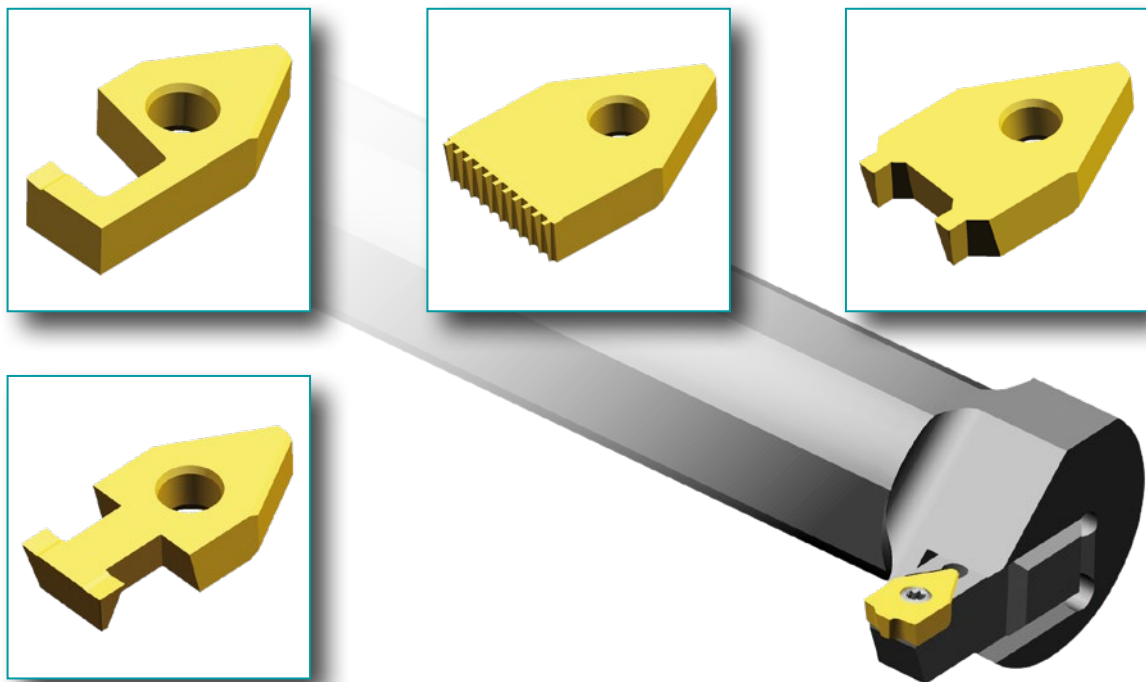

Special tool holders

Sophisticated solutions for your requirements

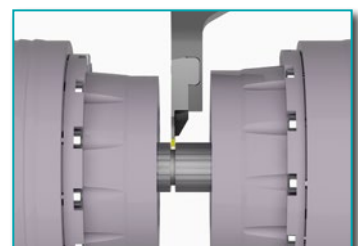
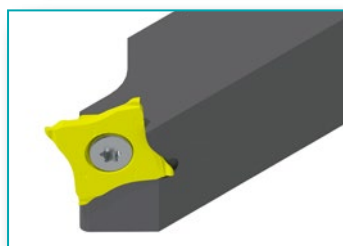
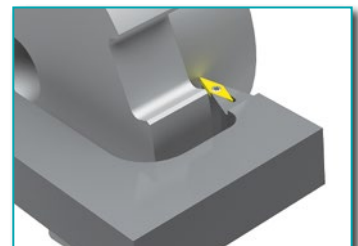
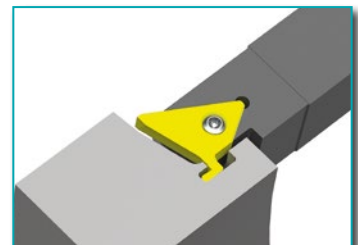
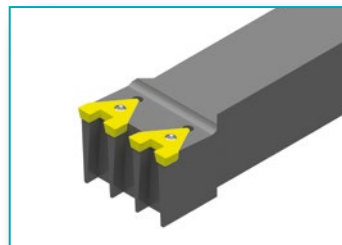
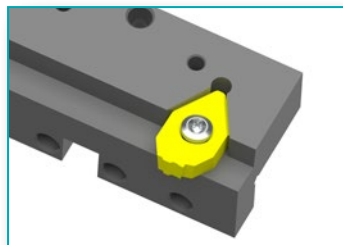
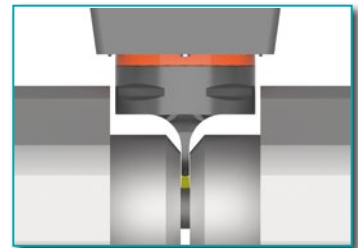
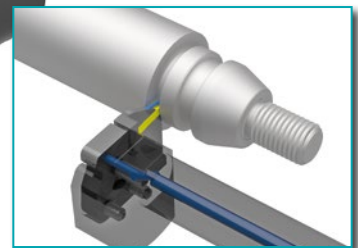
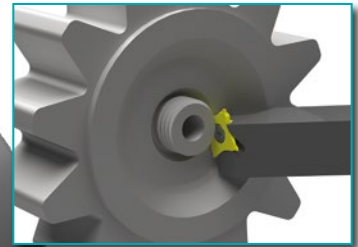
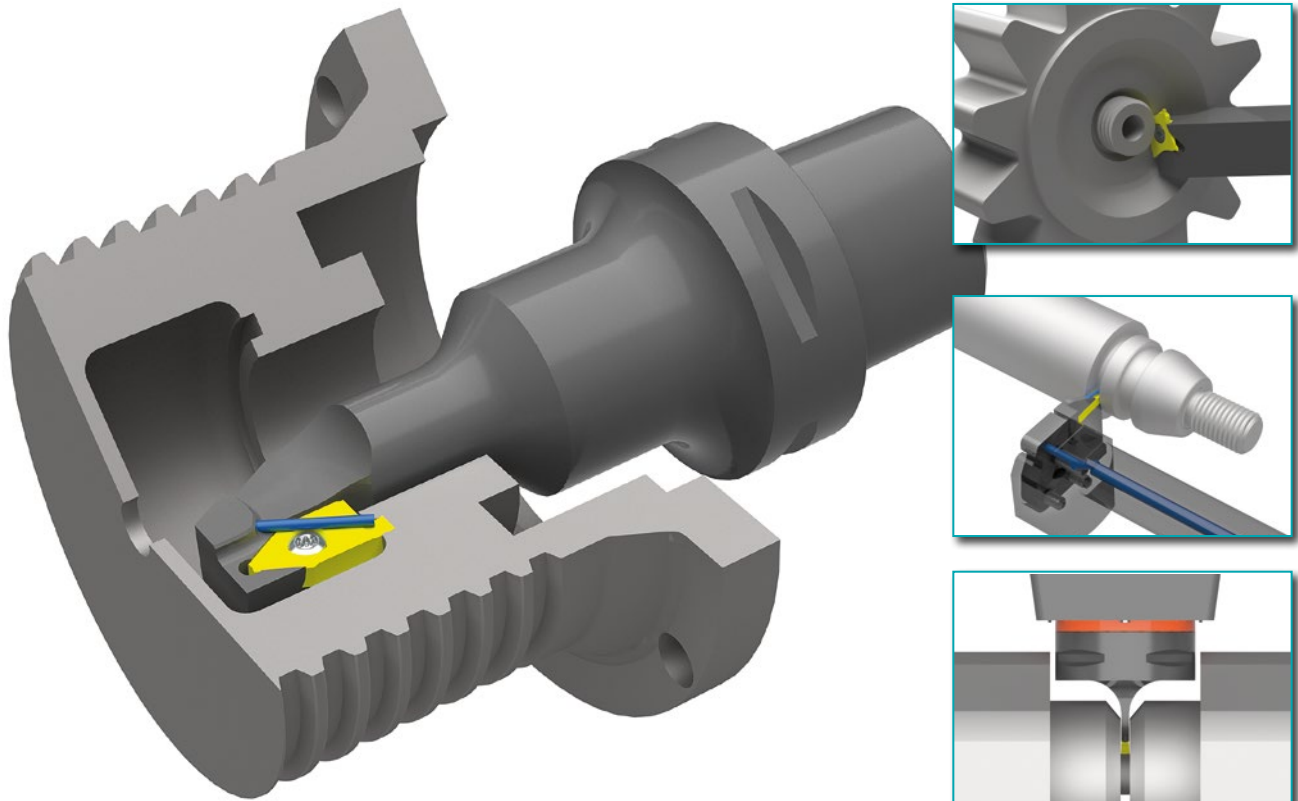

Two examples for cost saving solutions

The cutting and grooving insert MTNZ 4 Nanospeed completely finishes the shaft; front and rear side of the pinion.



Actual situation:

Expensive production sequence caused by awkward turning operations using left and right tool holders. The customer delegates the problem to the designer.

Process:

At first he considers the problem.

Some days later, he has found the solution.

Profile cutting and face grooving operation with one HSK toolholder

Goal: The quantity of tool changes needs to be reduced.

Mission: Development of a special tool holder to reduce tool changes, but still remain stable.

Solution: Special tool holder HSK with 2 insert systems and the unique GLM interface which creates a big variety of more applications.



Tool changes reduced to ONE for TWO applications!

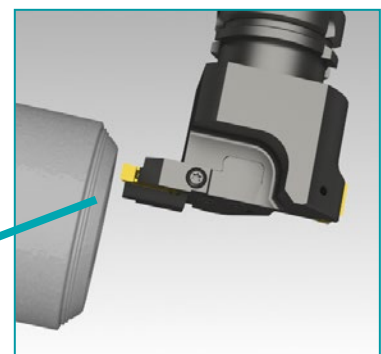
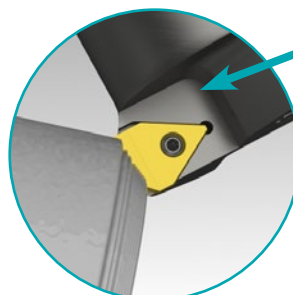

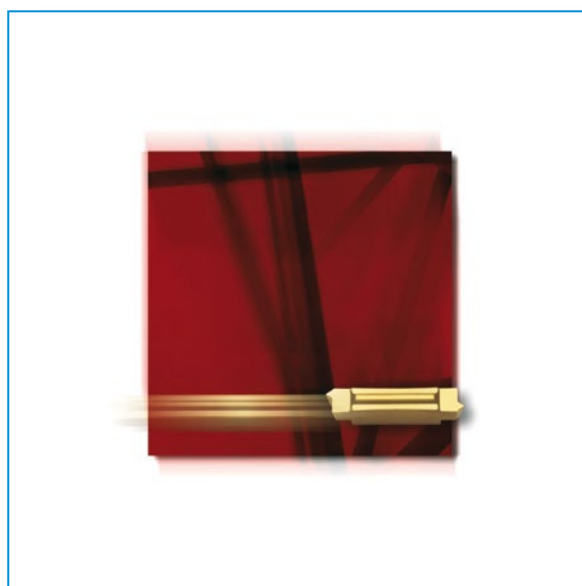
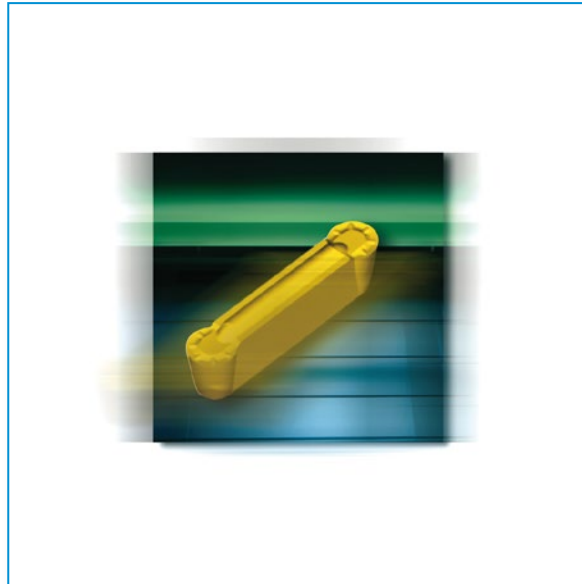

High pressure cooling system

- ▶ *Prevents heat development*
- ▶ *Easy chip flow*
- ▶ *Increases tool life*

Hi Pressure Cooling System
Tailor made

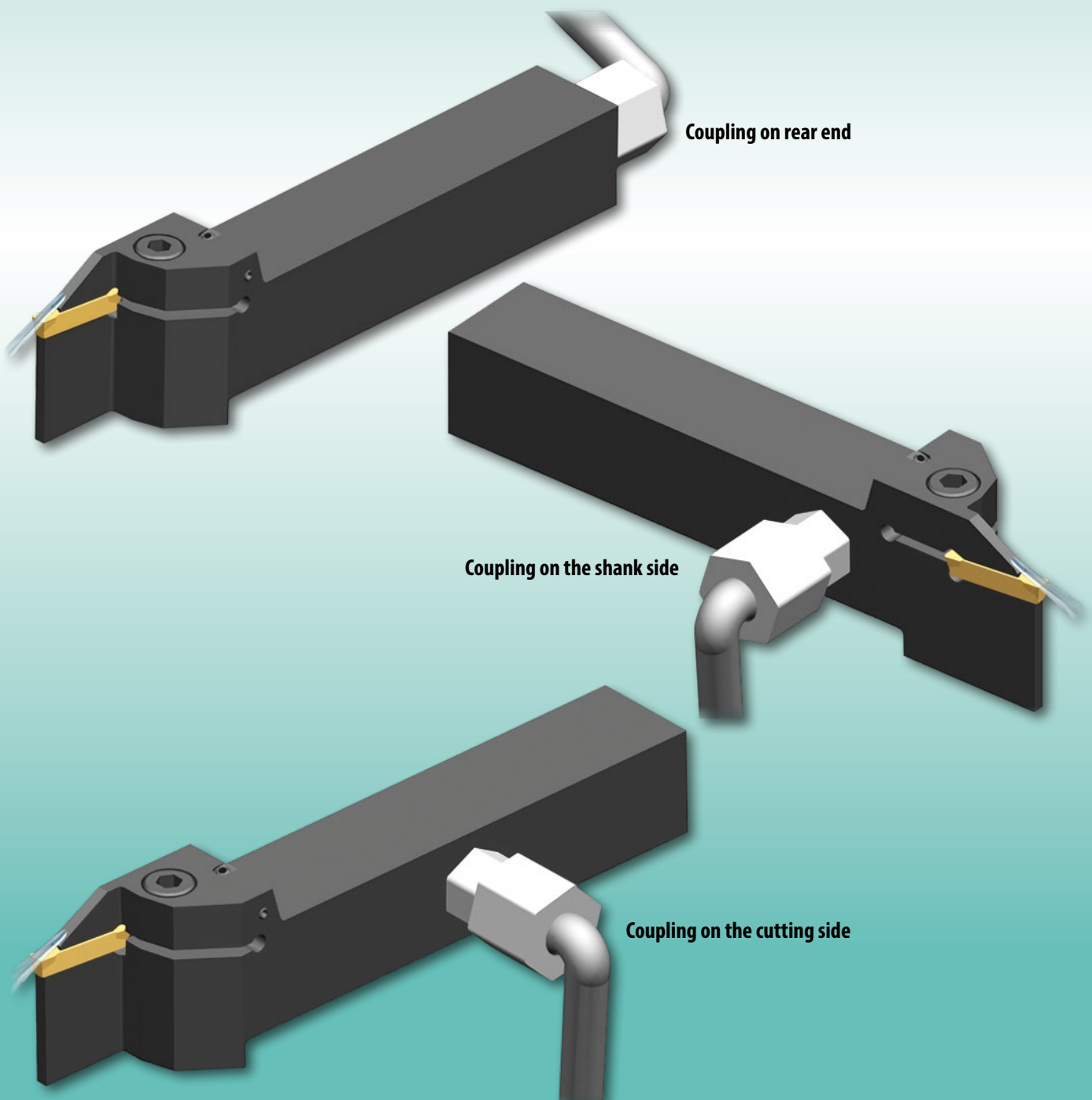

Order sheet for tool holders without coupling from page 219 to 221

Available systems

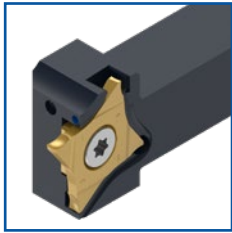

Multicut 4-System

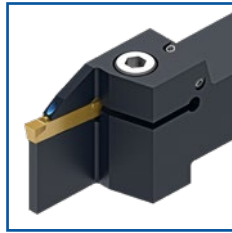

P92-System

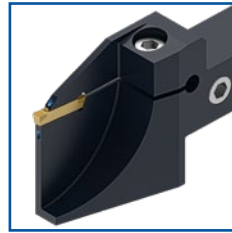

P92 A-System

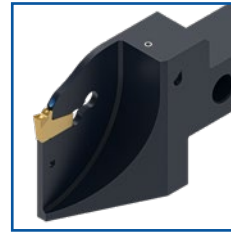

FlexFix-System

How to order a tool holder:

LH holder

Description tool holder
from page 219 to 221

Tool holder ID: Stück

RH holder

Description tool holder
from page 219 to 221

Tool holder ID: Stück

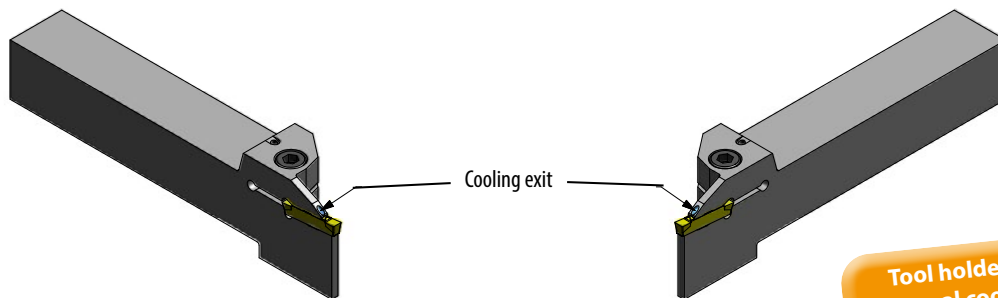

Tool holder without
internal cooling, price:
149,50 €/pc.
+ VAT



Quantity	ID-Nr.	Ref.

Company | Kd.-Nr.

Street + Nr.

Postal code / city

Phone or Mail

You can find more templates for download on our homepage: www.kemmerhmw.de

Order sheet for tool holders with 1 coupling on the side (Special solution)

Thread options

Filling in recommendation

- Variable dimensions defined by customer: L, L3, L4, G1, G3 und G4
- Enter the required thread option from page 217 and 218
- Enter the required holder from pages 219, 220 or 221
- Enter the required dimensions in the square fields. For instance: L4 = 96 mm
- Cross the required thread, please. For instance: M8x1



LH holder

Description tool holder from page 219 to 221

Tool holder ID: piece

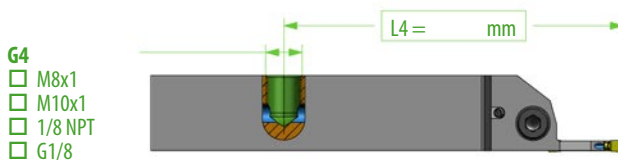
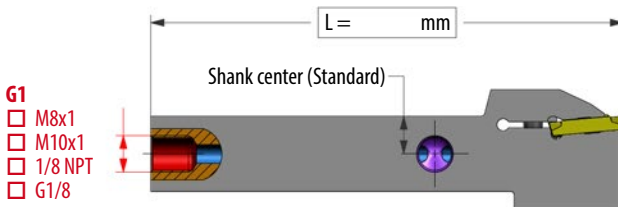
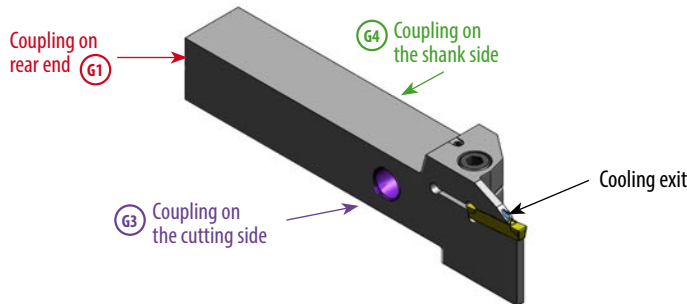

RH holder

Description tool holder from page 219 to 221

Tool holder ID: piece

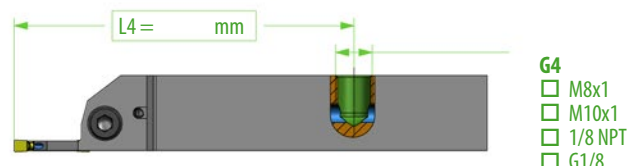
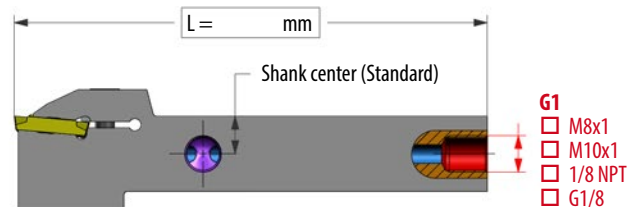
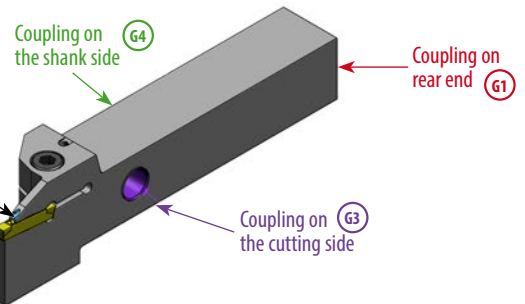

The IK-special solution includes 1 coupling on the side and 1 coupling on rear end with the same thread incl. 1 plug.

Basic tool holder including 1 lateral variable cooling coupling
210,- € +VAT

Order sheet for tool holders with 2 coupling on the side (Special solution)

Thread options

Filling in recommendation

- Variable dimensions defined by customer: L, L3, L4, G1, G3 und G4
- Enter the required thread option from page 217 and 218
- Enter the required holder from pages 219, 220 or 221
- Enter the required dimensions in the square fields. For instance: L4 = 96 mm
- Cross the required thread, please. For instance: M8x1



LH holder

Description tool holder
from page 219 to 221

Tool holder ID: Stück

RH holder

Description tool holder
from page 219 to 221

Tool holder ID: Stück

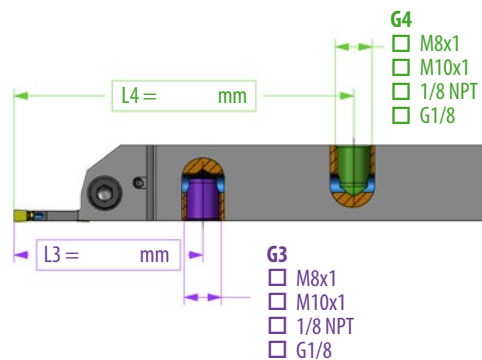
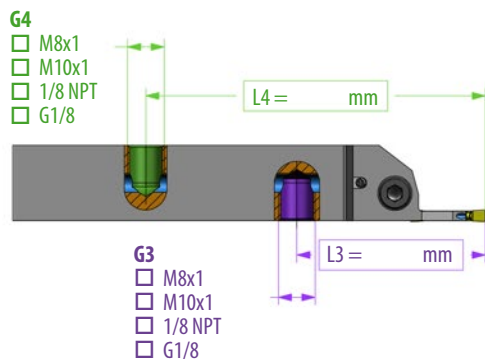
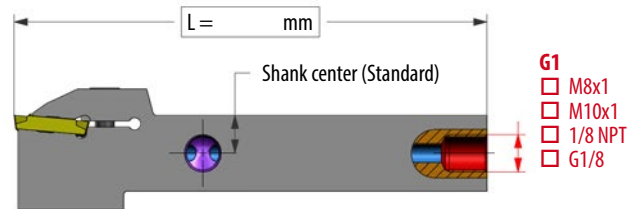
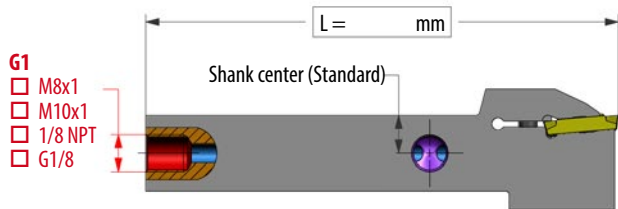
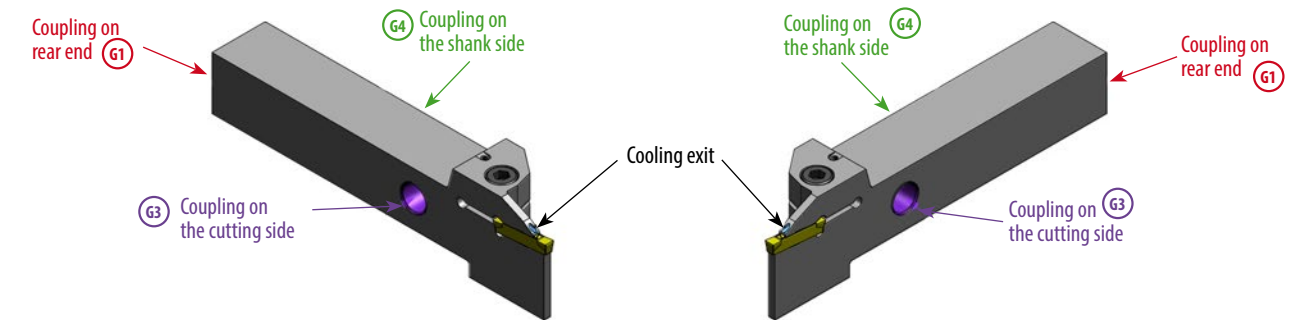

The IK-special solution includes **1 coupling** on the side and **1 coupling** on rear end with the same thread incl. 1 plug.

Basic tool holder including 2 lateral variable cooling coupling

225,- € + VAT

Tool holder with IC | without coupling | System Multicut 4

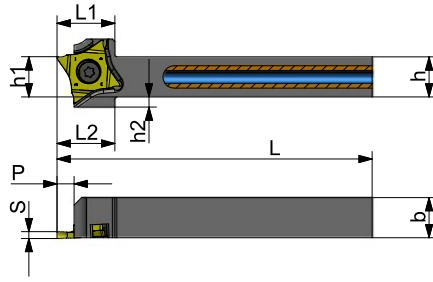

Hi Pressure Cooling System
Tailor made



WG4020 Ref.	Tool holder ID-Nr.	pocket size	()	h	h1	h2	b	f	P	L	L1	L2	
ID-Nr.													
M92 Q FXCBL 1212 K16HP	60244	16	L	12	12	8	12	12,3	6,5	125	23,0	27	34+39+40
M92 Q FXCBL 1616 K16HP	60245	16	L	16	16	4	16	16,3	6,5	125	23,0	19,5	33+39+40
M92 Q FXCBL 2020 K16HP	60246	16	L	20	20	-	20	20,3	6,5	125	23,0	-	33+39+40
M92 Q FXCBL 2525 M16HP	60247	16	L	25	25	-	25	25,3	6,5	150	23,0	-	33+39+40
M92 Q FXCBL 1212 K16HP	60248	16	R	12	12	8	12	12,3	6,5	125	23,0	27	34+39+40
M92 Q FXCBL 1616 K16HP	60249	16	R	16	16	4	16	16,3	6,5	125	23,0	19,5	33+39+40
M92 Q FXCBL 2020 K16HP	60250	16	R	20	20	-	20	20,3	6,5	125	23,0	-	33+39+40
M92 Q FXCBL 2525 M16HP	60251	16	R	25	25	-	25	25,3	6,5	150	23,0	-	33+39+40

Fitting inserts

Torque p. 226, 227, 252 | Tech. Section p. 229 | pocket size p. 230 | Hauptschneide (Späneinlauf) p. 232 | p. 29 + 30 | p. 31 | p. 32 | p. 33 | p. 34 | p. 35-37 | p. 52 | p. 83-86

Tool holder with IC | without coupling | System P92

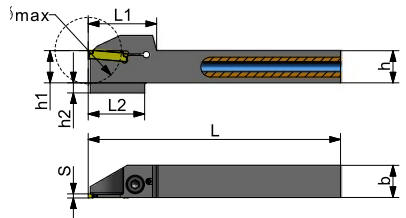

Hi Pressure Cooling System
Tailor made



WG3800 Ref.	Tool holder ID-Nr.	pocket size	()	Ø max	h	h1	h2	b	P	S	L	L1	L2	
ID-Nr.														
P92 CXCBL 1212 K20+25HP	48794	20+25	L	22	12	12	4	12	11	2+2,5	125	23	23	10
P92 CXCBL 1616 K20+25 11HP	48796	20+25	L	22	16	16	-	16	11	2+2,5	125	23	-	10
P92 CXCBL 1616 K20+25 17HP	48723	20+25	L	34	16	16	5	16	17	2+2,5	125	34	26	1
P92 CXCBL 2020 K20+25 17HP	48728	20+25	L	34	20	20	-	20	17	2+2,5	125	34	-	1
P92 CXCBL 1212 K20+25HP	48733	20+25	R	22	12	12	4	12	11	2+2,5	125	19,5	19,5	10
P92 CXCBL 1616 K20+25 11HP	48735	20+25	R	22	16	16	-	16	11	2+2,5	125	19,5	-	10
P92 CXCBL 1616 K20+25 17HP	48740	20+25	R	34	16	16	5	16	17	2+2,5	125	34	26	1
P92 CXCBL 2020 K20+25 17HP	48745	20+25	R	34	20	20	-	20	17	2+2,5	125	34	-	1

Fitting inserts

Torque p. 226, 227, 252 | Tech. Section p. 229 | pocket size p. 230 | p. 61 - 69 | p. 71 | p. 74-80 | p. 83-86

Tool holder with IC | without coupling | System P92

P92 CXCBL HP

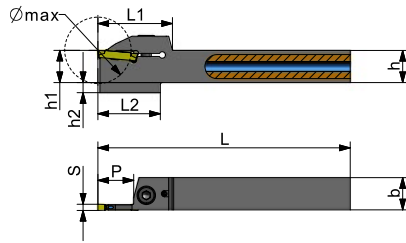

P92 CXCBR HP



Hi Pressure Cooling System
Tailor made

WG3800 Ref.	Tool holder ID-Nr.	pocket size	(C)	Ø max	h	h1	h2	b	P	S	L	L1	L2	
	ID-Nr.													
P92 CXCBL 1212 K30 14HP	48798	30	L	28	12	12	5	12	14	3,0	125	30	26	11
P92 CXCBL 1616 K30 14HP	48800	30	L	28	16	16	5	16	14	3,0	125	34	26	1
P92 CXCBL 1616 K30 17HP	48805	30	L	34	16	16	5	16	17	3,0	125	37	29	1
P92 CXCBL 2020 K30 17HP	48810	30	L	34	20	20	5	20	17	3,0	125	37	29	1
P92 CXCBL 2525 M30 17HP	48815	30	L	34	25	25	-	25	17	3,0	150	37	-	2
P92 CXCBR 1212 K30 14HP	48820	30	R	28	12	12	5	12	14	3,0	125	34	26	11
P92 CXCBR 1616 K30 14HP	48822	30	R	28	16	16	5	16	14	3,0	125	34	26	1
P92 CXCBR 1616 K30 17HP	48827	30	R	34	16	16	5	16	17	3,0	125	37	29	1
P92 CXCBR 2020 K30 17HP	48832	30	R	34	20	20	5	20	17	3,0	125	37	29	1
P92 CXCBR 2525 M30 17HP	48837	30	R	34	25	25	-	25	17	3,0	150	37	-	2

Fitting inserts

- Torque p. 226, 227, 252
- Tech. Section p. 229
- pocket size p. 230
- p. 61 - 70
- p. 71
- p. 74-80
- Hard material machining p. 83-86

Tool holder with IC | without coupling | System P92 A

P92 A CXCBL HP

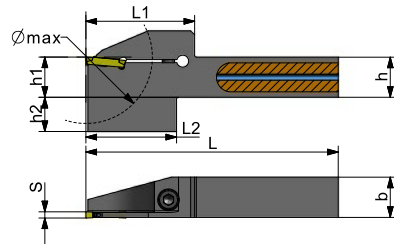
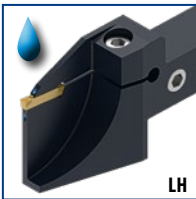

P92 A CXCBR HP



Hi Pressure Cooling System
Tailor made

WG3800 Ref.	Tool holder ID-Nr.	pocket size	(C)	Ø max	h	h1	h2	b	S	L	L1	L2	
	ID-Nr.												
P92 A CXCBL 2020 K30HP	48754	30	L	65	20	20	17	20	3,0	125	54	45	12
P92 A CXCBL 2020 K40HP	48759	40	L	65	20	20	17	20	4,0	125	54	45	12
P92 A CXCBL 2525 M30HP	48764	30	L	65	25	25	12	25	3,0	150	54	45	12
P92 A CXCBL 2525 M40HP	48769	40	L	65	25	25	12	25	4,0	150	54	45	12
P92 A CXCBR 2020 K30HP	48774	30	R	65	20	20	17	20	3,0	125	54	45	12
P92 A CXCBR 2020 K40HP	48779	40	R	65	20	20	17	20	4,0	125	54	45	12
P92 A CXCBR 2525 M30HP	48784	30	R	65	25	25	12	25	3,0	150	54	45	12
P92 A CXCBR 2525 M40HP	48789	40	R	65	25	25	12	25	4,0	150	54	45	12

Fitting inserts

- Torque p. 226, 227, 252
- Tech. Section p. 229
- pocket size p. 230
- p. 61 - 70
- p. 71
- p. 74-80
- Hard material machining p. 83-86

Tool holder with IC | without coupling | System Flex Fix

F16L...42 HP

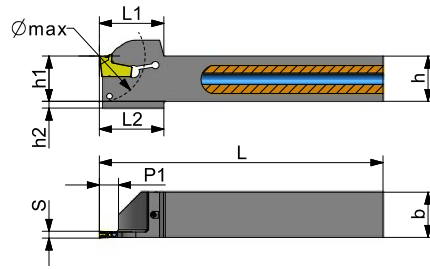
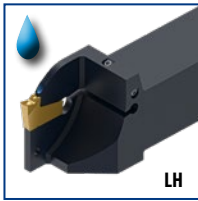

Hi Pressure Cooling System
Tailor made

F16R...42 HP



WG3205 Ref.	Tool holder ID-Nr.	pocket size	(C)	Ø max	h	h1	h2	b	P1	S	L	L1	L2	
	ID-Nr.													
F16 L 2020 K30 42HP	48710	FF3	L	42	20	20	3	20	8	3,0	125	28,5	25	AWF16
F16 L 2525 M30 42HP	48715	FF3	L	42	25	25	0	25	8	3,0	150	28,5	25	AWF16
F16 R 2020 K30 42HP	48700	FF3	R	42	20	20	3	20	8	3,0	125	28,5	25	AWF16
F16 R 2525 M30 42HP	48705	FF3	R	42	25	25	0	25	8	3,0	150	28,5	25	AWF16

F16L...65 HP

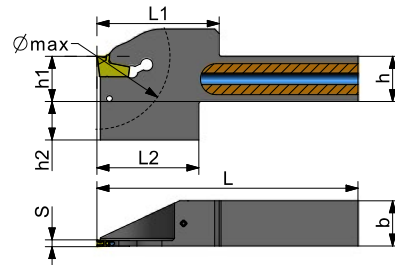
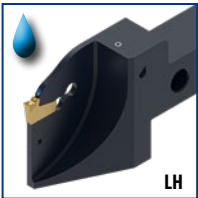

Hi Pressure Cooling System
tailor made

F16R...65 HP



WG3205 Ref.	tool holder ID-Nr.	pocket size	(C)	Ø max	h	h1	h2	b	S	L	L1	L2	
	ID-Nr.												
F16 L 2020 X30 65HP	48690	FF3	L	65	20	20	17	20	3,0	115	54	45	AWF16
F16 L 2525 X30 65HP	48695	FF3	L	65	25	25	12	25	3,0	140	54	45	AWF16
F16 R 2020 X30 65HP	48680	FF3	R	65	20	20	17	20	3,0	115	54	45	AWF16
F16 R 2525 X30 65HP	48685	FF3	R	65	25	25	12	25	3,0	140	54	45	AWF16

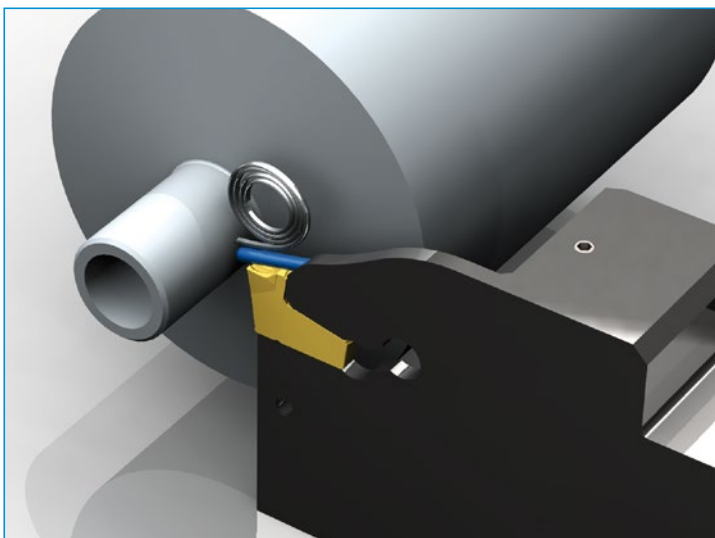

KEEP COOL!

Coolant jet hits the hot spot.

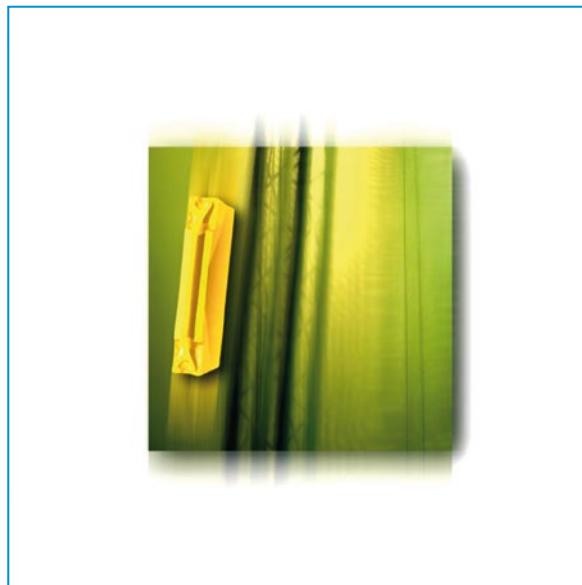

- Preventing heat
- Reducing wear
- Easy chip flow
- Increasing tool life



Spare parts and accessories



Spare parts

WG355 Spare parts	ID-Nr.		ID-Nr.		Recommended Torque [Nm]
1	13701	M 5x16	14746	P4	7
2	13707	M 6x20	14747	P5	14
3	13709	M 8x25	14748	P6	14
4	15635	TXM 4x16 15	12900	T15W	3,8
5	13702	M 5x20	14746	P4	7
6	13700	M 5x12	14746	P4	7
7	15166	M 4x8 DIN 7984	14745	P3	5
8	13699	M 5x10	14746	P4	7
9	18777	TXM 4x12	12900	T15W	3,8
10	41015	TXM 4x12/15	40681	T15F	3,8
11	13698	M 4x16	14745	P3	5
12	13708	M 6x25	14747	P5	8
13	15086	M 3x12 DIN 913 (hex-socket pin)	14743	P1,5	0,8
14	13705	M 6x16	14747	P5	14
15	14846	LM 4x8	12771	P2,5	3
16	10397	Order Nr. 1856 (Ejector)	-	-	-
17	10398	26 L (fitting strip)	-	-	-
18	13696	M 4x10	14745	P3	5
19	16203	M 5x10 DIN 7984	14746	P4	7
20	14749	M 4x16 DIN 913 (hex-socket pin)	14744	P2	1,9
21	21949	M 5x20 DIN 913 (hex-socket pin)	12771	P2,5	4
22	14846	LM 4x8 DIN 7380	14745	P3	3
23	34839	TXM 5x14 25	31353	T25W	5
24	35587	TXM 5x10 25	31353	T25W	5
25	29276	TXM 5x13 20	29312	T20W	5
26	33051	M 5x8 DIN 914 (hex-socket pin)	35393	P2,5	6
27	35166	LM 3x8 DIN7380	14744	P2	1,5
28	34656	Order Nr. 34656 (Ejector A-TWIN)	-	-	-
29	37353	LM 6x20 (Lentiform-head screw)	38549	TX25	7
30	37556	M4x4 (hex-socket pin)	14744	P2	4
31	37221	Fitting strip KL 32	-	-	-
32	44188	M 8x20 1	14747	P6	14
33	44641	TXM5x14 10 25	45130	TX25/10	4,5
34	44817	TXM5x10 10 25	45130	TX25/10	4,5
35	34839	TXM 5x14 25	38549	TX25	7
36	44609	TXM5x13 20P92C	29312	T20W	5
37	44630	TXM6x17 20P92C	29312	T20W	5
38	45133	52 L (fitting strip)	-	-	-
39	45113	WK 25 10 (change-over blade)	-	-	-
40	45112	TX 6 (grip)	-	-	-
41	45130	TX25/10 (ET 39+40)	-	-	-
42	49360	M 4x6 DIN 914 (hex-socket pin)	14744	P2	1,8
43	19621	M5x16 DIN7984	14746	P4	7
44	54555	M5X0,5WN	14745	P3	3
45	59522	M6x12 DIN7984	14747	P5	8

Further technical information on torques on page 226.

Spare parts for GLM-ISO-cartridges with positive pocket

WG355 Cartridges Ref.							
	ID-Nr.	ID-Nr.	ID-Nr.	ID-Nr.	ID-Nr.	ID-Nr.	ID-Nr.
GLMCL/R DC11T3	40679	40680	42889	40678	40681		
GLMCL/R CC09T3	-			40677	40681		
GLMCL/R VC1604	42656	40680	42889	40678	40681	41105	14747
GLMCL/R VC1303	13025	13024	14744	13026	16003	44117	14747

Spare parts for GLM-ISO-cartridges with negative pocket

WG355 Cartridges Ref.										
	ID-Nr.	ID-Nr.	ID-Nr.	ID-Nr.	ID-Nr.	ID-Nr.	ID-Nr.	ID-Nr.	ID-Nr.	ID-Nr.
GLMCL/R CN1204	42671	42749	18154	42652	42739	14745	42637	47168	41105	14745
GLMCL/R DN1506	42658	42749	18154	42653	42739	14745	42637	47168	41105	14745
GLMCL/R VN1604	15261	12760	14744	-	-	-	-	-	41105	14745
GLMCL/R WN0804	42668	42750	18154	42652	42739	14745	42637	47168	41105	14745

Spare parts for GLM-ISO-cartridges for ISO threading inserts

WG355 Cartridges Ref.					
	ID-Nr.	ID-Nr.	ID-Nr.	ID-Nr.	ID-Nr.
GLMCL/R 16ER ISO	42664	40680	42889	40678	40681

Spare parts for tools with internal cooling

WG355 ID-Nr.			
	ID-Nr.	ID-Nr.	ID-Nr.
47436	M8x1	14746	P4
53273	M10x1	14747	P5
57680	G1/8x5.5	14747	P5
57759	G1/8x8	14747	P5
49528	NPT 1/8	14747	P5
58511	M6x4	14747	P5
59526	O-RING 4X1		

Torque key



Torque VARIO ST plus
T-handle torque tool

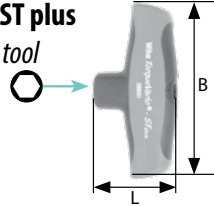

Torque Vario-S
Torque screwdriver



WG355 Ref.	Torque Nm	ID-Nr.		L	B	D	Interchangeable blades
Torque VARIO ST plus	5,0 - 14,0	43723	6	56	120	-	WS + WT
Torque Vario-S	1,0 - 5,0	43884	4	138	-	36	WSF + WTF

Handle: Window scale displays torque value numerically. Torque infinitely adjustable with Torque-Setter setting tool (also supplied). Soft-grip T-handle for optimal torque transmission. Audible and perceptible click when the pre-set torque has been attained.

Standards: Based on EN ISO 6789, BS EN 26789, ASME B107.14M.

Accuracy: ±6%, traceable to national standards.

Application: For applications where recommended torque settings are important. Use in combination with an interchangeable 6 mm blade for Wiha T-handle torque tools.

Extra: Delivered in practical plastic box, incl. factory calibration certificate.

Handle: Ergonomic multi-component handle, particularly light and compact. Handle sizes proportioned to optimise torque setting. Audible and perceptible click when the pre-set torque has been attained.

Standards: EN ISO 6798, BS EN 26789, ASME B107.14M.

Accuracy: ±6%, traceable to national standards.

Application: For applications where recommended torque settings are important. Use in combination with a Wiha torque interchangeable blade.

Extra: Delivered in practical plastic box, incl. factory calibration certificate.

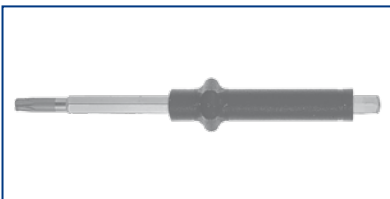

Torx-Interchangeable blades

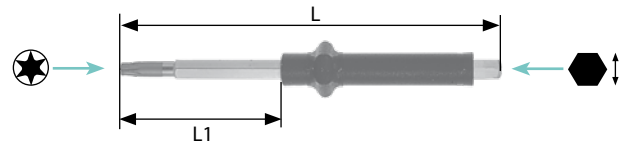

WG355 Ref.	ID-Nr.			L	L1	max Nm	max in.lbs
WTF15	43888	T15	4	175	42	5,5	-
WT15	43716	T15	6	130	53	6	53
WT20	43717	T20	6	130	53	10	88
WT25	43718	T25	6	130	53	15	132



hex-Interchangeable blades

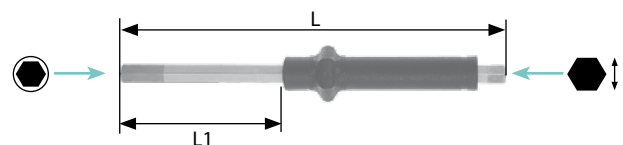

WG355 Ref.	ID-Nr.			L	L1	max Nm	max in.lbs
WSF2	43885	2	4	175	42	1,8	-
WSF2,5	43886	2,5	4	175	42	3,8	-
WSF3	43887	3	4	175	42	5,5	-
WS3	43719	3	6	130	53	9	79
WS4	43720	4	6	130	53	15	132
WS5	43721	5	6	130	53	15	132
WS6	43722	6	6	130	53	15	132

Blade: High quality chrome-vanadium-molybdenum steel, through hardened. Wiha ChromTop® finish on tip for a perfect fit. Colour-coding Torx-iterchangeable blades: dark green.

Colour-coding: Hex interchangeable blades: red.

Application: For applications where recommended torque settings are important.

Special screwdriver for MULTICUT 4 holders and blades

Special screwdriver with interchangeable blade to change MULTICUT 4 inserts in confined spaces

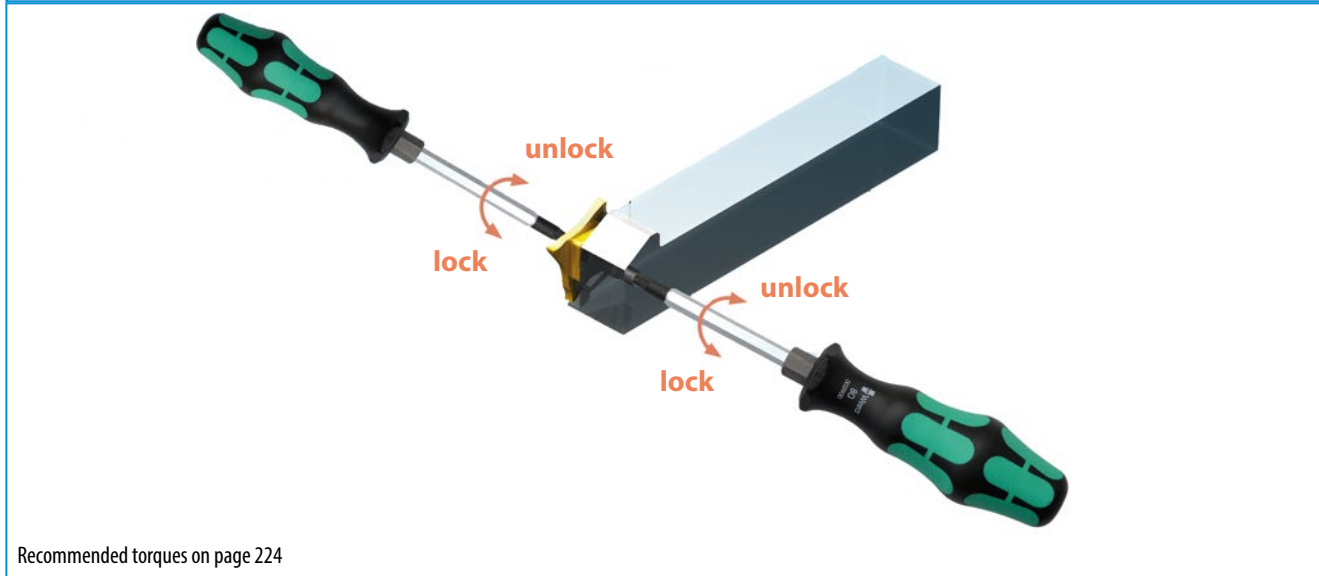

Recommended torques on page 224



TX 6
Handle

ET-Nr.	WG355 Ref.	ID-Nr.	Items
40	TX 6	45112	Handle

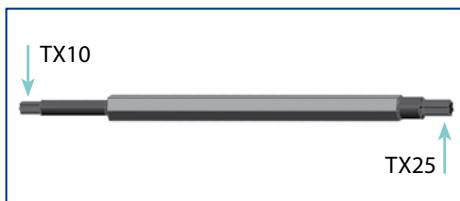

WK 25 10
interchangeable
blade

ET-Nr.	WG355 Ref.	ID-Nr.	Items
39	WK 25 10	45113	Blade



TX 25 10
Screwdriver

ET-Nr.	WG355 Ref.	ID-Nr.	Items
41	TX 25 10	45130	Torque screwdriver

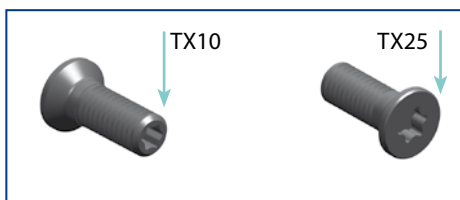

TXM5x14 10 25
Torx screw

ET-Nr.	WG355 Ref.	ID-Nr.	Erläuterung	Recommended Torque max. [Nm]
33	TXM5x14 10 25	44641	Torx screw L=14	4,5
34	TXM5x10 10 25	44817	Torx screw L=10	4,5

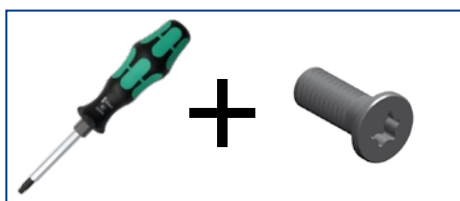

TX 25 10 1
TX 25 10 2
Screwdriver and torx

Set-offer

WG355 Ref.	ID-Nr.	Items
TX25 10 1	45131	Set contents: spare part numbers 39 + 40 + 33
TX25 10 2	45132	Set contents: spare part numbers 39 + 40 + 34

Remark:

Torx screw ET-Nr. 34, L = 10 mm, fitting small holders 10 x 12 mm and 12 x 12 mm and blades (p. 43 - 45).

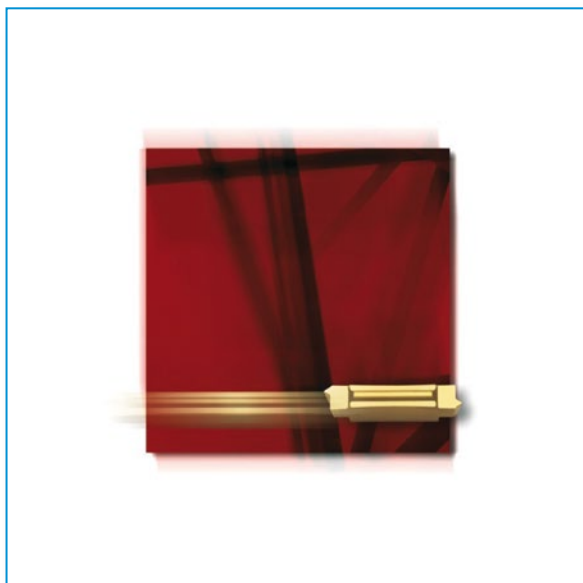
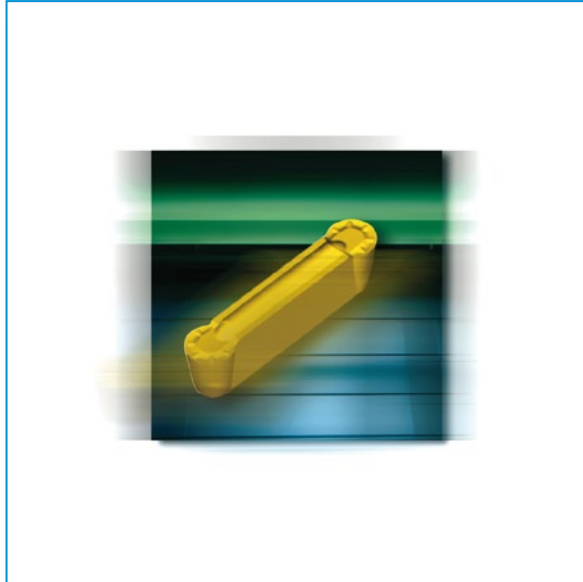

Technical section

Basics, speeds, feeds, coatings and explanations

Symbols	p. 230
Abbreviations	p. 230
List of available geometries for grooving, turning, parting off	p. 232
Select chip breaker	p. 231
Select grade and speed	p. 234
Select feeds	p. 235
Recommendations for parting off and turning	p. 236
Hardness range of grades with principle recommendations	p. 237
Basics to select the right tools	p. 238
Tool application on the main and counter spindle	p. 239
Coatings	p. 240
Wear marks and tips to solve them	p. 242
Recommendation for cutting and turning	p. 243
Explanations on face grooving	p. 244
Basics for threading	p. 245
Tool holder damages: cause, effect and solution	p. 252
Technical section GLRM MULTICUT circular milling	p. 253
Material comparison table	p. 254
Product index	p. 260

Symbols

Symbols	Ref.
	Rotation/Run
	Diameter
	Angle
	Internal Cooling

Symbols	Ref.
	Pitch
	Groove width
	Outside
	Hard material machining

Symbols	Ref.
	Inside
	Spare parts
	Weight

Abbreviations

Abbreviation	Meaning
ALU	Aluminium
ap	Cutting depth [mm]
b	Width
CCW	Counter clockwise
CW	Clockwise
D	Degree
e. g.	For instance
f	Cutting feed [mm/Revolution]
h	Height
ID-Nr	Identification Number
L	Length
IK	Anschluss für Innenkühlung
F	Fasenbreite

Abbreviation	Meaning
LH	Left hand
max	No more than
min	No less than
o. r.	On request
P	Extension range
p.	Page, e.g. p. 16 = page 16
R	Radius
Ref.	Reference order code
RH	Right hand
S	Width of cutting edge [mm]
Vc	Cutting speed [m/min]
ls	Nebenschneidenlänge
a. A.	Auf Anfrage



















































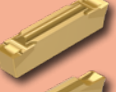

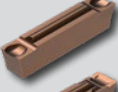





















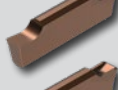





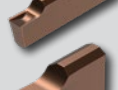





pocket size



System/Pocket size	1,5	2,0	half 2,0	2,5	3,0	half 3,0	3,5	4,0	half 4,0	5,0	6,0	8,0	10,0	15,0	16,0
MC4,															16
MC4 Fräser															S16
P92,	15	20		25	30	K30	35	40		50	60	80	100		
P92-P								P40	PK40	P50					
P92-S		S20	SK20												
P92-2/90					30			40							
P92-2					30			40		50					
FF		FF2			FF3			FF4							
PP		PP2			PP3			PP4		PP5					
STD (Standard Design)		SD2			SD3			SD4		SD5	SD6				
F92															F13

Selection of chip breakers and feeds

Select the most efficient chip breaker for the different materials

	Steel	Stainless steel	Cast iron	Nonferrous materials	Difficult to cut materials	Hard materials
Cutting and turning	MTNS 	MTNS 	OTXS 	BTNG 	BTNG 	BTNG Hardlox 2 
	MTNZ 	VTNS 	MTNS 	HTNST 	CTDS 	MTNS Hardlox 2 
	CTDS 	CTDS 	CTDS 	HTNS 	RTNG 	RTNG Hardlox 2 
	VTNS 	MTNZ 	OTXC 	OTXS 	XTNS 	
	RTNX 	RTNG 	PTNSM 	RTNG 	BTNX 	
	BTNX 	XTNS 		BTNG 	STNZ 	
	GTNS 	BTNG 		STNZ 	GTNS 	
	PTNSM 	GTNS 			MTNSG 	
Grooving and parting off	CTD 	STNS 	CTD ALU 	CTD ALU 	XTNS 	BTNN Hardlox 2 
	SCTD 	BTNS 	ITNS 	SFN 	SFN 	CTD ALU Hardlox 2 
	BTNN 	CTD 	HTNS 	BFN 	BFN 	SCTD Hardlox 2 
	ITNS 	SCTD 	IFN 		IFN 	KCTD Hardlox 2 
	BTNS 	BTNN 	ITN 		IFN ALU 	HTNS Hardlox 2 
	IFN 	XTNS 				ITNS Hardlox 2 
	BFN 	SFN 				STNS Hardlox 2 
	ITPN 	BFN 				KHTNS Hardlox 2 
	BGPN 	SNPN 				
	BGN 	SNTN 				
		BGPN 				
	BGN 	BGN 				
OFQ16 	OFQ16 	OFQ16 	OFQ16 	OFQ16 	OFQ16 Hardlox 2 	

List of available geometries for grooving, turning and parting off

Type	Ref.	Geometry (chip breaker)	Main cutting edge	Shape and details of minor edges	Kinds of machining	Grooving	Turning	Parting off	Kopieren/ISO Drehen	A PERFECT MATCH	Additional recommendations	Catalogue ref. for detailed information	
1st choice: grooving and turning	Maikräfer	MTNS MTNSG		positive 7°	Horizontal edges with s-shaped chip breakers for easy chip flow	Roughing, Finishing	☺	☺	○		GF 110 Alox for cast materials and free cutting steel	Suitable for parting-off small diameters	 p. 61, p. 84
	Maikräfer Z	MTNZ		positive R	wave shaped chip breaker teeth	Roughing	○	☺	○		KM Nanospeed for stainless materials	Turning with increasing feed until chips become short	 p. 66
	BG/BX Geometry	BTNG BTNX		positive R	Horizontal edges with parallel	Finishing		●			GF110 NANOSPEED controlling chip flow on stainless steels	BTNG a good choice on nickel alloys	 p. 69, p. 84
	Snake	STNZ STNG		positive R	Arc shaped edges	Finishing and copy turning	○	●			KM AluSpeed finishing nonferrous heavy metals	The type STVR/L (P92P) suitable for turning with 35° edge angle	 p. 63, p. 128
	Victory	VTNS		positive 12°	Horizontal edges with large, v-shaped chip breakers for efficient chip flow	Finishing to roughing	●	●	○		PM ALOX machining cast iron	The main chip breaker suitable for parting off alloys	 p. 61
	CS Geometry	CTDS		negative 10°	Sharply ground edges	Super finishing	○	●			PM TILOX super finishing	A unique insert for perfect surfaces	 p. 63
	X-Geometry	XTNS		negative 9°	16° positive chip entry with integrated chip breaker dents	Roughing semifinishing	●	●	○		KM TILOX excellent machining stainless steels	A very good choice of parting off components starting with interrupted cutting	 p. 68
	Exotic	ETNZ		positive 9°	Positive top rake available with 0° chamfer or sharp cutting edge	Roughing, finishing		☺			GF 110 Hardspeed for heat resisting materials	Wiper geometry for excellent super finishing surfaces	 p. 64
	PT Geometry	PTNSM		positive R	No minor cutting edges	Finishing		●	○		GF 110 Tilox for universal applications	Super positive geometry for machining difficult-to-cut materials and none ferrous materials	 p. 65
	OC Geometry	OTXC		negative 10°	Straight cutting edge with negative chamfer	Roughing, finishing	☺	☺	☺		CVD-coated insert for cast materials	Parting off, grooving and grooving and turning of cast materials	 p. 70
	OS Geometry	OTXS		neutral 0°	Horizontal edge with flat top	Finishing	○	○			Tailor made inserts with different coatings on systems P92 and P92P	Grind a negative chamfer to machine cast iron	 p. 70
	RG Geometry	RTNG		positive 13°	Horizontal parallel chip breaker and ground cutting edge	Finishing, copying				☺	GF110 NANOSPEED machining heat resisting alloys	Copying with system P92 P and Multicut 4	 p. 71, p. 85
	RX Geometry	RTNX		positive 10°	Horizontal parallel chip breaker with integrated teeth	Roughing and copying				☺	KM TILOX roughing stainless steels	Copying with system P92 P and Multicut 4	 p. 71
	Gozilla	GTNS		positive R	No minor cutting edges	For face grooving, roughing and finishing	●	○	●		GF 110 Tilox for universal applications	Especially designed for face grooving	 p. 67
	STV-Geometry	STVR/L		positive R	Positive top rake for best possible chip control when turning or copying	Turning with ISO 35° edge angle				☺	KM Aluspeed for aluminum alloys	Ideal shape when machining in narrow spaces	 p. 128
	STD-Geometry	STDR/L		positive 23°	Positive top rake for best possible chip control when turning or copying	Turning with ISO 55° edge angle				☺	GF 110 Hardspeed for heat resisting materials	Ideal for machining in narrow spaces	 p. 129
DECO-Geometry	OTX DECO		positive 10°	Positive top rake for best possible chip control when back turning	Decolletage machining on Swiss sliding head automatics				●	PM Nanospeed for free cutting materials	Edge is cutting easily without vibrations	 p. 130	
Heuberg-T	HTNST		neutral 0°	Sharply ground edges with arc shaped chip breaker	Super finishing	○	●			KM TILOX for chip control	For automatic lathes and sliding head machines	 p. 145	

● = First choice | ○ = 2nd choice | ☺ = Recommended | R=Shape of geometry in longitudinal intersection

List of available geometries for grooving, turning and parting off

Type	Ref.	Geometry (chip breaker)	Main cutting edge	Shape and details of minor edges	Kind of machining	Grooving	Turning	Parting off	Kopieren/ ISO Drehen	A PERFECT MATCH	Additional recommendations	Catalogue ref. for detailed information
1st choice: parting off and grooving	B-Geometry	BTNN BTNS BFN BGP BGN		positive	No minor edges chip breaker	universal				☺	BTNN KM TILOX for all kinds of parting-off	Groove slightly below center p. 74, p. 85 p. 143 p. 160 p. 171, p. 178
	C-Geometry	CTD		negative	No minor edges chip breaker	difficult to cut materials	●		●		PM NANOSPEED zum Abstechen von rostfreiem Stahl	Good choice for interrupted cuts p. 78
	Supernova	SCTD STNS SFN SNP SNT		positive	No minor edges chip breaker	universal	○		☺		PM NANOSPEED for instable conditions	For lathes and machine tools with low power p. 79, p. 86 p. 144, p. 150 p. 162 p. 170, p. 176
	I-Geometry	ITN IF ITP		negative	No minor edges chip breaker	difficult to cut materials	●		●		Chamfer reinforces cutting edge	Good choice for interrupted cuts p. 177 p. 161 p. 171
	LT-Geometry	LTNN		positive	No minor edges chip breaker	non ferrous metal				☺	GF 110 Carbospeed for alloy steels	Especially suitable for double spindle automatics p. 80
	ALU Geometry	CTD ALU IF ALU ITP ALU IT ALU		positive	No minor edges chip breaker	non ferrous metal	●		●		Instable conditions and thinwalled parts	Good choice for exotic materials p. 77, p. 86 p. 162 p. 178
Heuberg	HTN		positive	Sharp edges	universal	●		●		PM NANOSPEED machining free cutting materials	For automatic lathes and sliding head machines p. 144, p. 150	
1st choice: Multicut 4	OFQ cutting	OFQ...N/ R/L...		positive	No minor edges chip breaker	grooving and parting off	●		●		FM Tilox for steel	Ground chip breaker starting from width 1,5 mm p. 29, p. 39
	OFQ Präzi	OFQ...N		positive	No minor edges chip breaker	precision grooving	●				FM Tilox for steel	Ideal for machining shapes according DIN 471 p. 31 + 32, p. 41
	OFQ Radius	OFQ...R...N		positive	Radial cutting edge for copying	finishing	●				FM Tilox for steel	Also suitable for super finishing p. 34, p. 40
	OFQ Axial	OFQ...A...		positive	No minor edges chip breaker	axial grooving	●				KM Carbospeed for alloyed steel	Suitable for face grooving from D > 15 mm outer cutting edge corner Maximum depth 5 mm p. 33
First choice: threading	OFQ thread	OFQ... ER/L... W/ISO		positive	Minor edge with cutting angle 60°/55°	ISO/Whitworth thread				☺	Type EIR for part profile	Threading basics see technical section p. 35 - 37, p. 42
	P92 S thread	HTNG		positive	Minor edge with cutting angle 60°/55°	ISO/Whitworth thread				☺	Type IR for inner thread	Threading basics see technical section p. 146 - 147 p. 154
	P92 P thread	OTX... ER/IR... W/ISO		neutral	Minor edge with cutting angle 60°/55°	ISO/Whitworth thread				☺	Type IR for inner thread	Threading basics see technical section p. 131 p. 131 p. 132 p. 139

● = First choice | ○ = 2nd choice | ☺ = Recommended | R=Shape of geometry in longitudinal intersection

Selection of grades and speeds

Recommended grades

Cutting conditions	Steel	Stainless steel	Cast iron	Nonferrous materials	Difficult to cut materials	Hard materials
interrupted cutting	PM ALOX/TILOX PM TILOX/CARBOSPEED KM TILOX/CARBOSPEED	PM TILOX/NANOSPEED KM TILOX/NANOSPEED	KM CASTSPEED KM TILOX GF110 NANOSPEED	GF110 NANOSPEED GF110	PM TILOX/NANOSPEED KM TILOX/NANOSPEED GF110 HYPERSPEED	HARDLOX 2
variable cutting depth, crusts, deposits	PM ALOX/TILOX	PM ALOX/TILOX	KM CASTSPEED PM ALOX/TILOX GF110 ALOX	KM	PM ALOX/TILOX	HARDLOX 2
even cutting	KM TILOX/CARBOSPEED GF110 TILOX	KM TILOX/NANOSPEED GF110 TILOX	KM CASTSPEED KM TILOX GF110 TILOX	KM NANOSPEED/ ALUSPEED	KM TILOX/NANOSPEED GF110 TILOX KM HYPERSPEED	HARDLOX 2

Recommended speeds

Steel

Material code	Grade	Cutting speed - m/min					Initial cutting speed in m/min
		60	120	180	240	300	
P	PM ALOX/TILOX/CARBOSPEED	↔					100
	KM TILOX/CARBOSPEED	↔					160
	FM TILOX/CARBOSPEED	↔					220
	GF110 TILOX/CARBOSPEED	↔					220
	G5530 CARBOSPEED	↔					260
	KM + PM CASTSPEED	↔					100

Stainless steel

Material code	Grade	Cutting speed - m/min				Initial cutting speed in m/min
		60	120	180	240	
M	PM TILOX/NANOSPEED	↔				80
	KM TILOX/NANOSPEED	↔				120
	FM TILOX/NANOSPEED	↔				150
	GF110 TILOX/NANOSPEED	↔				150

Cast iron

Material code	Grade	Cutting speed - m/min							Initial cutting speed in m/min
		150	200	250	300	600	800	1100	
K	KM/GF110 TILOX/ALOX	↔							150
	KM+PM CASTSPEED GF110 CASTSPEED PLUS	↔							150
	PM TILOX	↔							800

Nonferrous materials

Material code	Grade	Cutting speed - m/min					Initial cutting speed in m/min
		150	300	450	600	750	
N	GF110 NANOSPEED/Aluspeed	↔					360
	KM NANOSPEED/Aluspeed	↔					450

Difficult to cut materials

Material code	Grade	Cutting speed - m/min								Initial cutting speed in m/min
		15	35	55	75	95	115	135	155	
S	PM ALOX/TILOX/NANOSPEED	↔								30
	KM TILOX/NANOSPEED/ HYPERSPEED	↔								45
	GF110 TILOX/NANOSPEED/ HYPERSPEED	↔								60

Hard materials

Material code	Grade	Cutting speed - m/min										Initial cutting speed in m/min
		15	35	55	80	100	130	160	200	220		
H	HARDLOX 2	↔										30

Further information on the ISO range can be found on the inside flap of the envelope at the back.



Selection of chip breaker and feeds

▶ **Recommended cutting depth and feeds for cutting inserts:**

MTNS chip breaker



- precision sintered inserts
- solid and rounded cutting edges

BTNG chip breaker



- precision ground inserts with sharp edges
- positive top rake

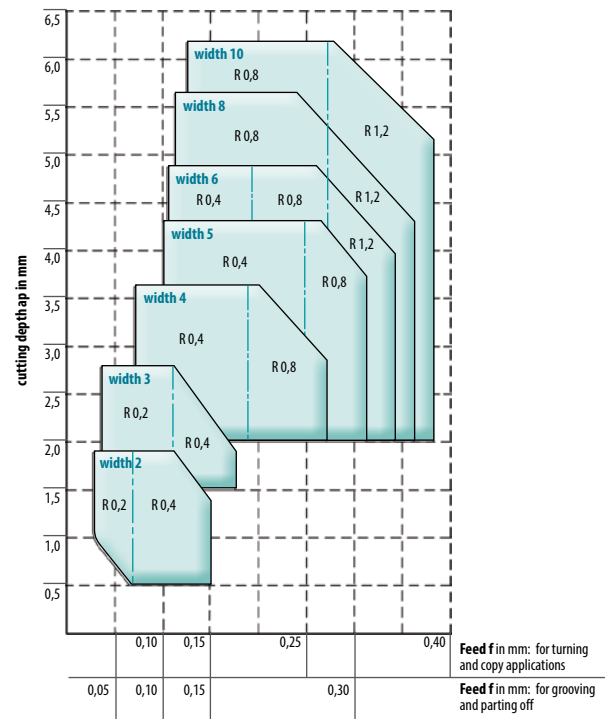
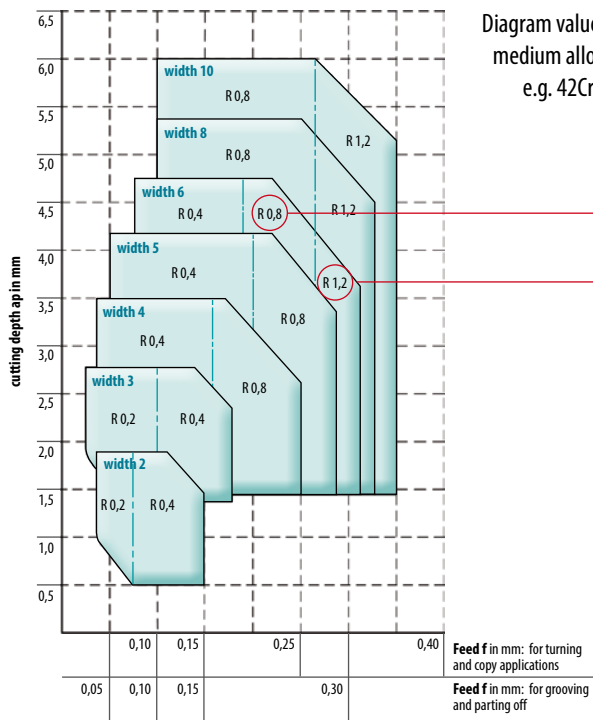

Remark: Select feeds according to the radius of inserts.
Diagram explanation: e.g. R 0,4 means corner radius of the insert is 0,4 mm.

Bigger radius require reducing cutting depths and allow increasing feed.

Example MTNS: width 6 mm
 R 0,8: ap max. 4,7 mm, → f max. 0,27 mm/U.
 R 1,2: ap max. 3,5 mm, → f max. 0,35 mm/U.

▶ **Recommended cutting depth and feeds for full radius inserts:**

RTNX chip breaker



precision sintered

On turning and copy turning the maximum cutting depth should not exceed half of the insert width e.g. cutting width 6 mm → cutting depth 3 mm

On turning and copy turning the maximum possible feed depends on the material to be machined and the cutting depth. On free cutting materials the feed may be increased multiplied by 1.8 e. g. MTNS 304, cutting width 3 mm, radius 0.4 mm, cutting depth 1.5, feed (Diagram) $0.15 \times 1.8 = 0.27$

RTNG chip breaker



precision ground

Recommendations for parting off

Parting off operating values and way of proceeding

Starting area

Start with a small value and gradually increase until you reach the ideal technical value:

Feed: $f = 0.02 - 0.05$

Start carefully! Otherwise the cutting edge may be damaged on the first cut.

Stable cutting conditions

Ideal chips can be machined with numerous geometries if correctly selected.

Feed: $f = 0.08 - 0.2$

Excellent chips, good tool life!

Runout area

Reduce feed before you reach the center (~ Ø 5 mm) to 0.02.

Feed: $f = 0.05 - 0.02$

Proceed carefully. Bad chip removal. No efficient cooling. Speed runs to zero.

A practical and safe way to select coatings and find appropriate speeds and feeds

Grades	cutting speed V_c in m/min	Feed f in mm/Rev.
Alloy Steel		
FM NANOSPEED	160 → 300	0,1 → 0,3
FM TILOX		
GF110 HARDSPEED		
GF110 NANOSPEED		
GS530 NANOSPEED		
KM TILOX		
PM NANOSPEED	120 → 240	0,08 → 0,3
Cast materials		
KM CASTSPEED	100 → 270	0,1 → 0,3
PM ALOX	100 → 200	0,1 → 0,3
Stainless Steel		
FM NANOSPEED	60 → 120	0,08 → 0,2
FM TILOX		
GF 110 NANOSPEED		
KM NANOSPEED		
KM TILOX		
PM NANOSPEED		
PM TILOX		
Red Speed		
Hard materials		
FM Hardlox 2	20 → 60	0,05 → 0,1
GF Hardlox 2		
KM Hardlox 2		

Hardness range of grades with principle recommendations

Grades	P	M	K
	Coarse grade structure Tough grades, safe against fracturing Wear quickly Low speeds Interrupted cut; Instable machining conditions	Medium to fine grades Tough and wear resisting, especially when PVD coated	Micrograin structure Brittle grades, liable to fracturing Wear resisting High speeds Even cuts; Perfect machining conditions

Grade hardness	40	35	30	25	20	15	10	5
FM Hardlox 2								
FM NANOSPEED								
FM TILOX								
GF 110 CARBOSPEED								
GF 110 Hardlox 2								
GF110 HARDSPEED								
GF 110 HYPERSPEED								
GF 110 NANOSPEED								
GF 110 NIROSPEED								
GF 110 TILOX								
GF 110 uncoated								
GF 25 uncoated								
GS 530 NANOSPEED								
KM AluSpeed								
KM CARBOSPEED								
KM CASTSPEED								
KM Hardlox 2								
KM HYPERSPEED								
KM NANOSPEED								
KM TILOX								
KM uncoated								
PM ALOX								
PM NANOSPEED								
PM Red Speed								
PM TILOX								
PM uncoated								

Basics to select the right tools

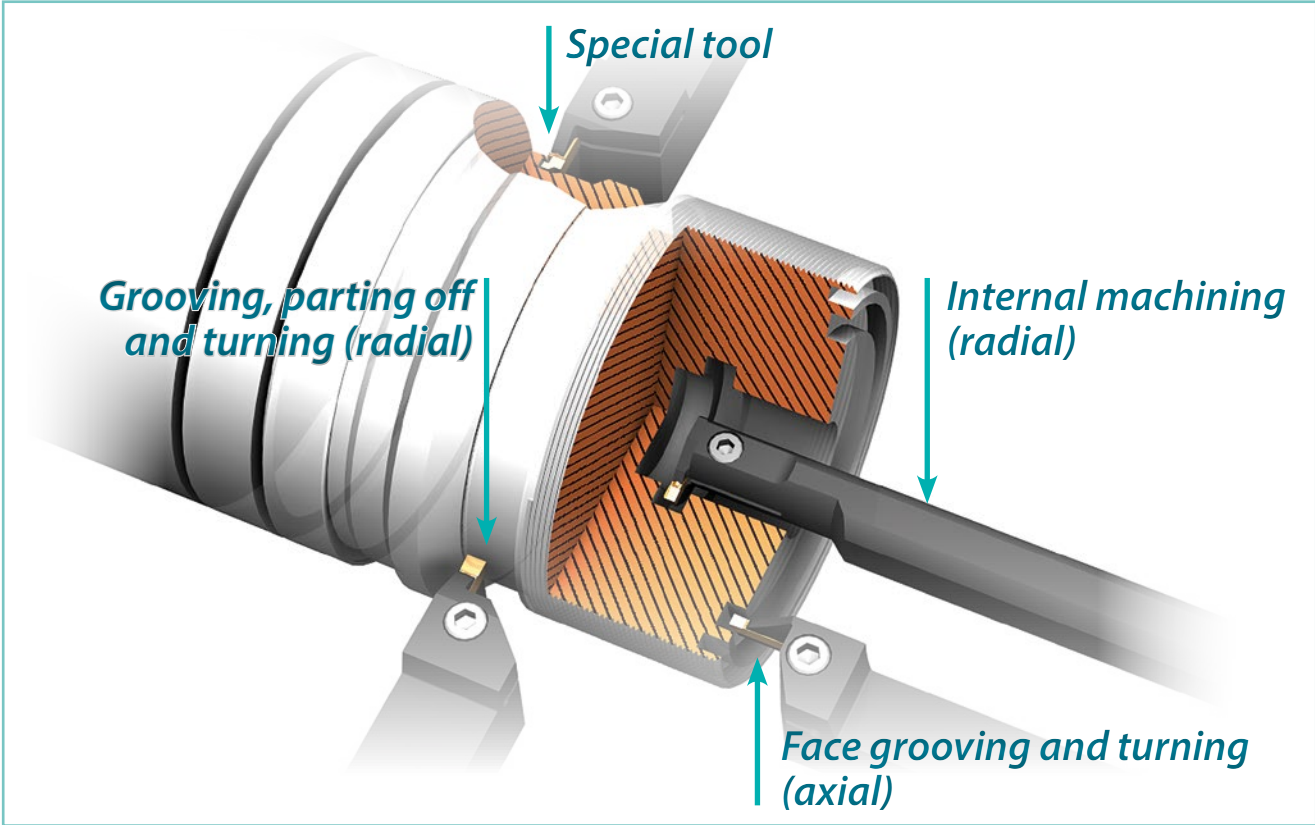

Cutting: Dimensions and formulas

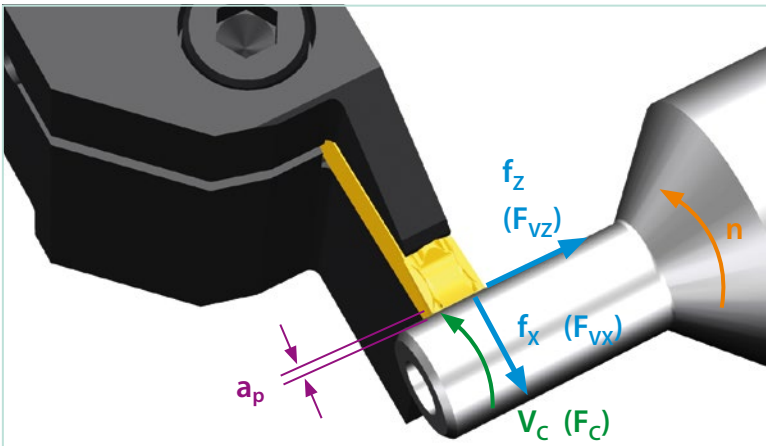

Dimensions

- a_p ... cutting depth [mm]
- F_c ... cutting force [N]
- F_{vx} ... feedforce in X - direction [N]
- F_{vz} ... feedforce in Z - direction [N]
- f_x ... feed in X - direction [mm]
- f_z ... feed in Z - direction [mm]
- n ... revolutions of main spindle [min^{-1}]
- V_c ... cutting speed [m/min]

Cutting speed V_c [m/min]:

Resulting force: **Cutting force (F_c)**

$$V_c = \frac{\pi \cdot d \text{ [mm]} \cdot n \text{ [min}^{-1}\text{]}}{1000}$$

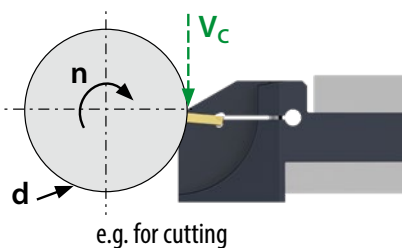

Feed f [mm/Rev]:

Resulting force: **Feedforce (F_f)**

$$f = \frac{L \text{ (depth) [mm]}}{\text{Revolution}}$$

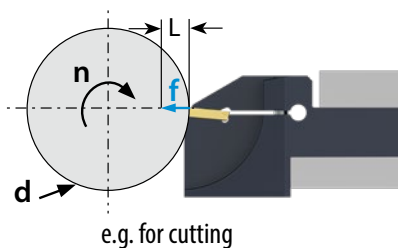

Cutting depth a_p [mm]:

Cutting depth for longitudinal turning

$$a_p = \dots \text{ mm}$$

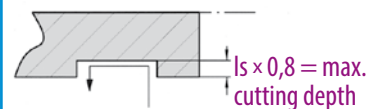

Dimension **ls x 0,8** is the maximum cutting depth referring to the minor cutting edges of the different chip breakers.

Tool application on the MAIN SPINDLE

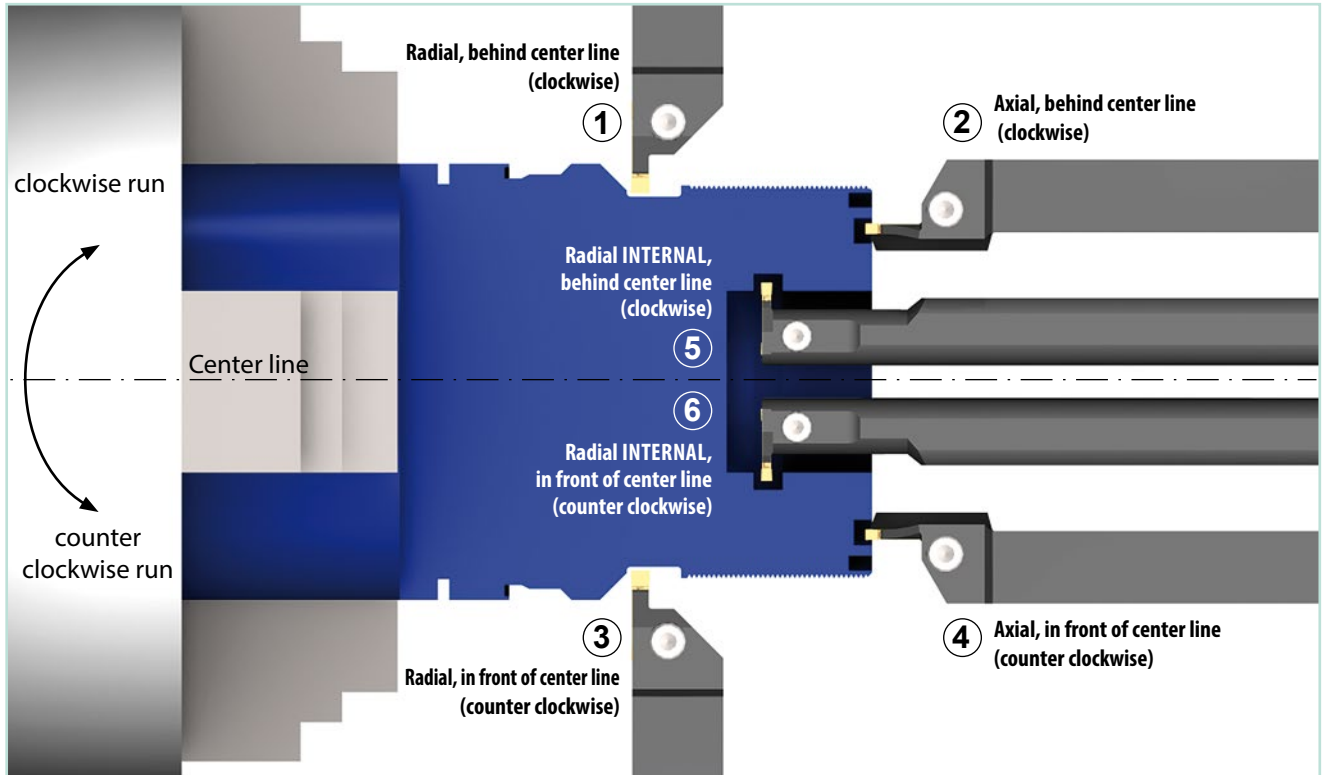

Tool application on the COUNTER SPINDLE

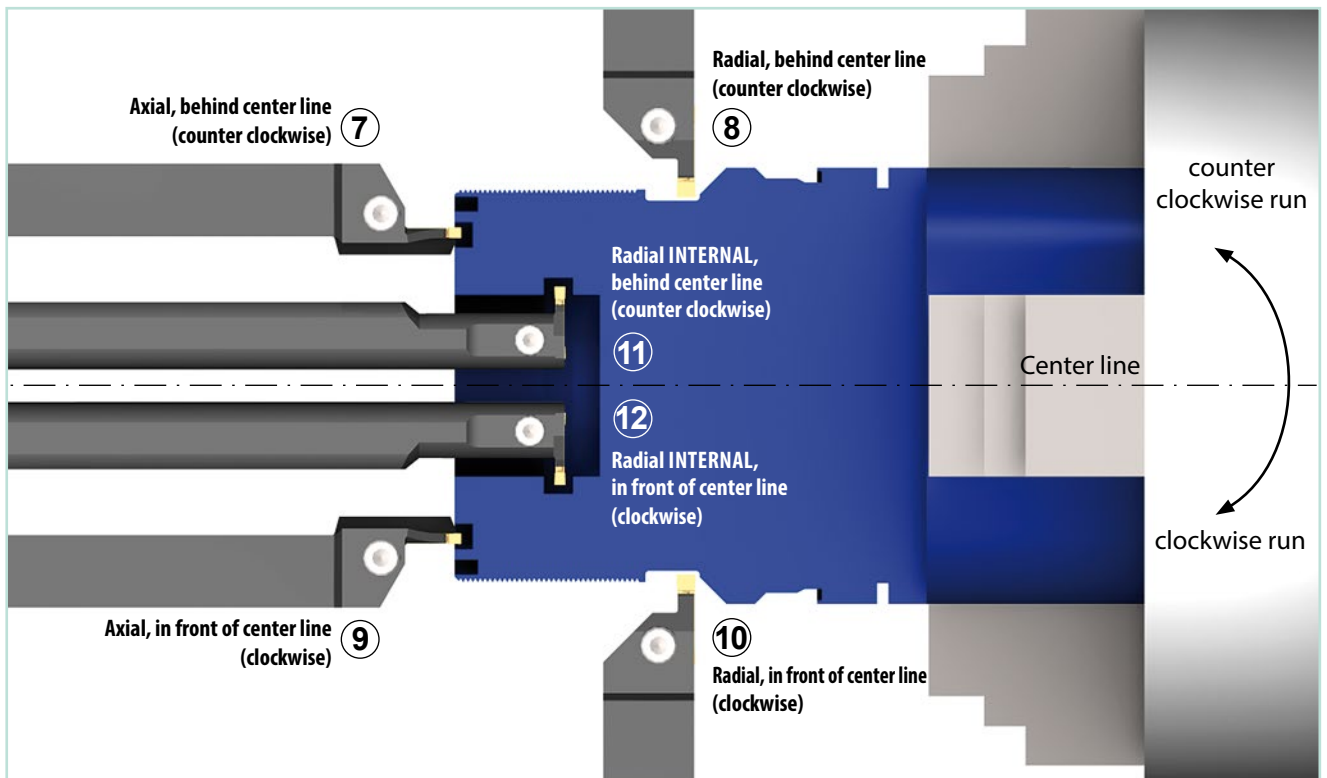

③ Point of reference in case of consulting

Coatings

ALOX
Coating type: Supernitrid



Description: Ideal coating for interrupted cuts and crusts with high wear resistance.
Application: cast iron, free cutting steel.
Layer thickness: 6 µm
Layer composition: Nanocomposite, TiAlN

AluSpeed
Coating type: Borid

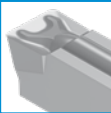

Description: High performance coating for smooth surfaces and easy chip flow.
Application: Aluminium, aluminium alloys, Titanium and non ferrous material.
Layer thickness: 2 µm
Layer composition: Monolayer

CARBOSPEED
Coating type: Powernitrid

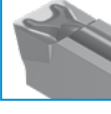

Description: Dense and hard coating layer with low residual stress. Excellent adhesive force and fine smooth surface.
Application: low and high alloy steel.
Layer thickness: 3 µm
Layer composition: Nanocomposite, TiAlCrN

CASTSPEED
Coating type: MT-CVD Gasphasen-deposition



Description: Perfectly connected to the lower layers. Extremely smooth surface. Suitable for dry machining.
Application: gray cast iron, alloy gray iron, spheroidal iron and malleable cast iron.
Layer thickness: 8 µm
Layer composition: AlTiN

CASTSPEED PLUS
Coating type: MT-CVD Gasphasen-deposition



Description: very thick, smooth and wear resistant coating.
Application: gray cast iron, alloy gray iron, spheroidal iron and malleable cast iron.
Layer thickness: 22 µm
Layer composition: TiCN

Hardlox 2
Coating type: Supernitrid



Description: Micro crystalline structure of the coating layer. Hardlox2 has been developed for hard materials with a hardness of more than 60HRC (Rockwell hardness)
Application: hardened materials.
Layer thickness: 3 µm
Layer composition: Nanocomposite AlTiN

HARDSPEED
Coating type: Supernitrid



Description: Micro crystalline structure of the coating layer provides smooth surfaces. For machining heat resistant materials with a hardness of more than 50HRC (Rockwell hardness).
Application: heat developing materials and difficult to cut materials.
Layer thickness: 3 µm
Layer composition: Nanocomposite, AlTiN

HYPERSPEED
Coating type: Supernitrid

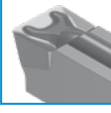

Description: Extremely fine and hard layer surface. Especially suitable for machining without coolant and difficult to cut materials.
Application: difficult to cut materials and titanium.
Layer thickness: 3 µm | **Layer composition:** Nanocomposite, AlTiN

NANOSPEED
Coating type: Supernitrid



Description: This TiN ALOX coating combines extreme hardness with high toughness. Owing to the golden colour of the coating, wearmarks can be identified more easily.
Application: tool steels and stainless steels
Layer thickness: 3 µm
Layer composition: Nanocomposite, TiAlN







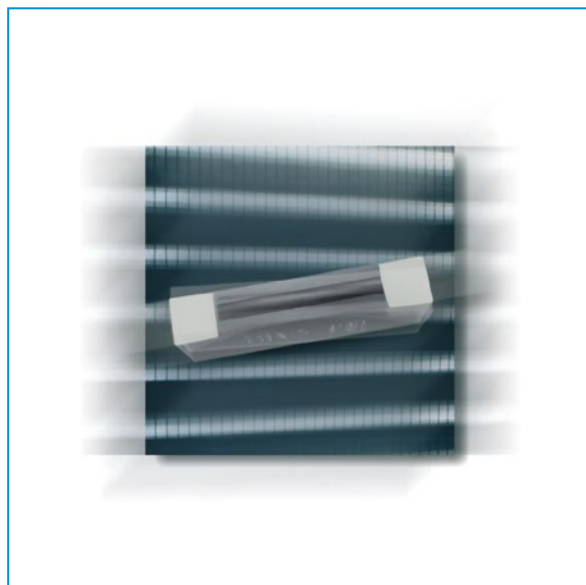
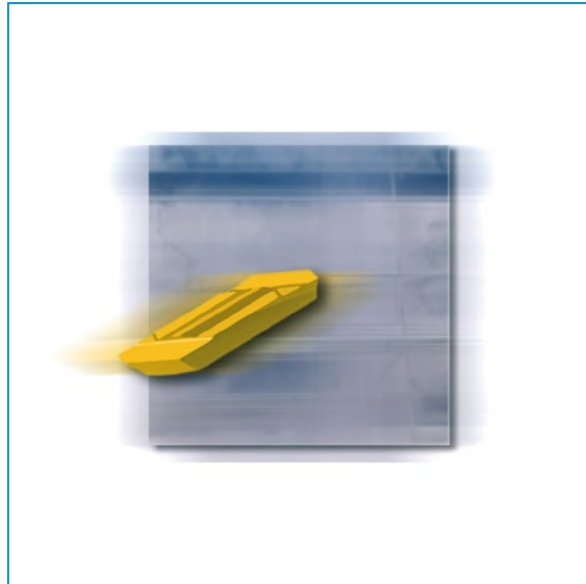

TILOX
Coating type: Supernitrid

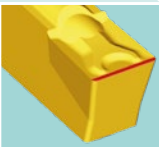

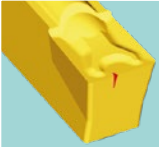
Description: The Tilox coating combines extreme hardness with high toughness and is suitable for a wide range of materials from steel to cast iron.
Application: steel, stainless steel and cast iron.
Layer thickness: 3 µm
Layer composition: Nanocomposite, TiAlN



Wear marks and tips to solve them

Recommendations		Take smaller corner radius	Take more positive geometry	Increase cutting speed	Reduce cutting speed	Increase cutting depth	Reduce cutting depth	Take a more wear resistant grade	Increase feed	Reduce feed	Take a tougher grade
Built-up-edge			☺	☺							
Splintering			☺	☺							☺
Wear on flanks or top clearances					☺			☺			
Notch wear					☺			☺			
Long chips			☺		☺				☺		
Crater wear						☺		☺	☺		
Plastic deformation					☺			☺		☺	
Cracks vertical to edge											☺
Vibrations		☺	☺		☺		☺		☺		

The cutting edge area shows the effects of undefined causes.
To assume the damage is due to unfit and/or a poor grade might be entirely wrong.



Recommendations for cutting and turning

Cutting and turning machining

The major cutting edge cuts a groove and then the minor edge turns in longitudinal directions

Different methods to cut and turn

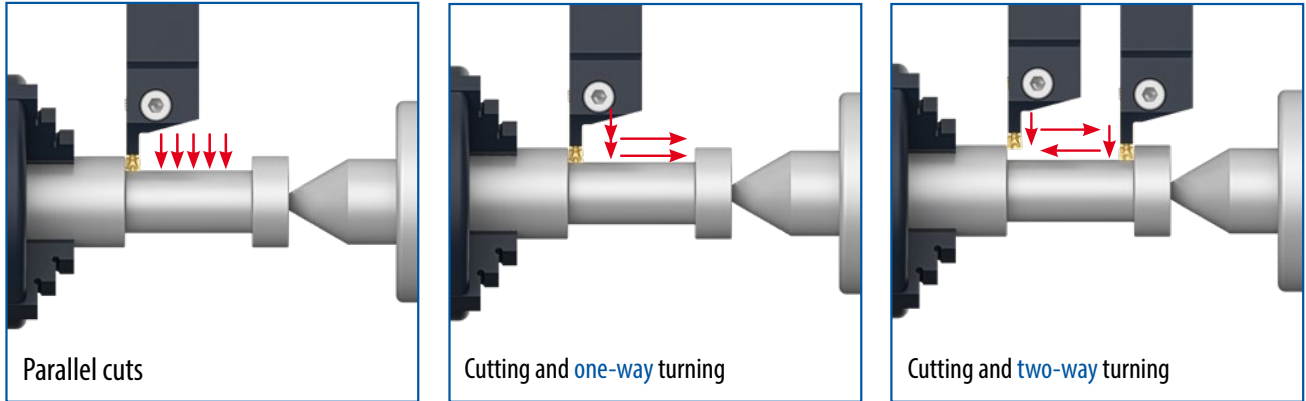

Major edge

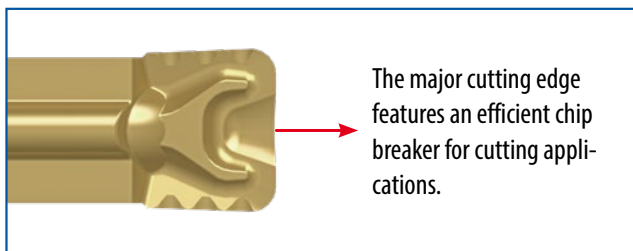

Minor edge

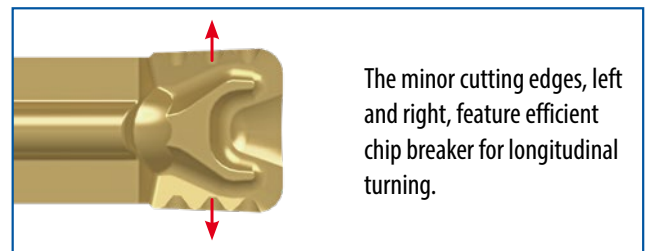

Grooving

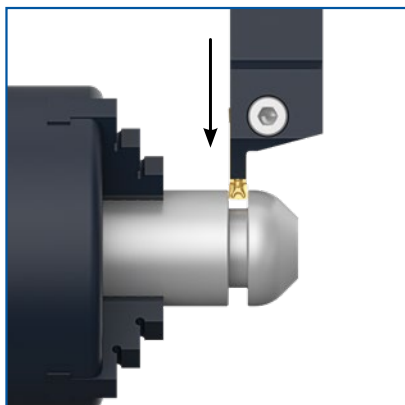

Grooving: MTNS insert with solid and rounded cutting edge

The major cutting edge cuts a groove.

Parting off

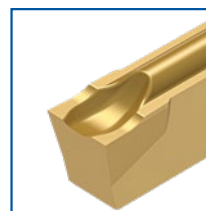

Parting off: BTNN insert featuring a large and efficient chip breaker

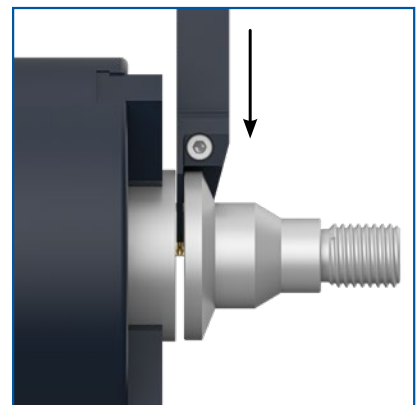

The major edge parts off a component from the bar.

Explanations on face grooving

Diameter for the 1st cut

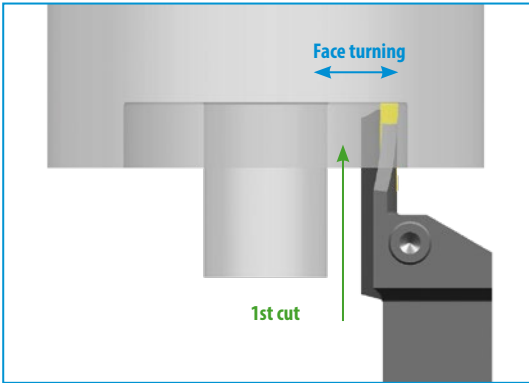

! Each cartridge fits for a certain diameter range. This range is marked as \varnothing_{\min} - \varnothing_{\max} . The 1st cut has to be positioned within this range. The dimension \varnothing_{\min} is reduced by the width of the cutting insert. After the 1st cut the groove width can be enlarged moving the tool radially to the center or to the outer diameter. No danger of collision! The following insert types are ideal for radial front turning: CTDS, MTNS, VTNS, MTNZ and BTNG.

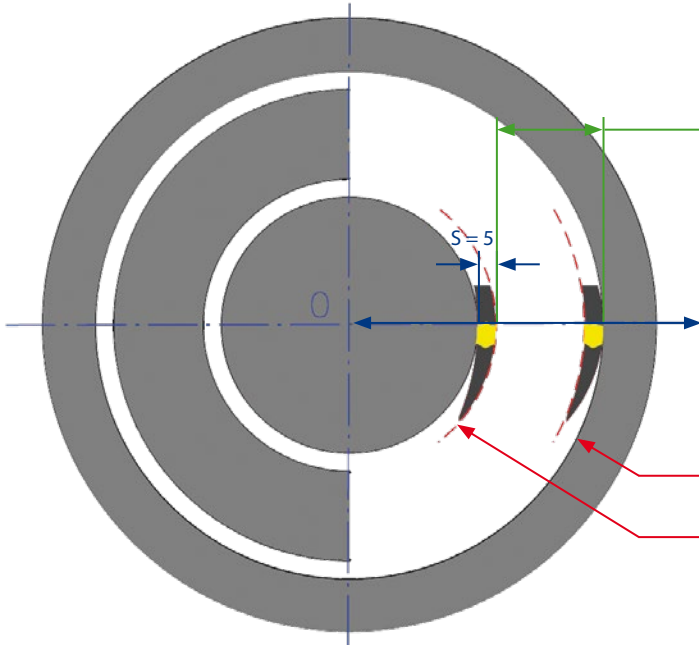

Tool holder: P92 2 CXCBR 2020 K50 75

Ø Range for the 1st cut

Provided the 1st cut has been set correctly, turning to the outer diameter or to the center is possible.

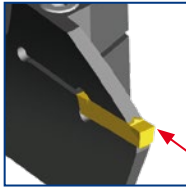

Edge corner facing the outer diameter of the component.

$\varnothing_{\max} = 130 \text{ mm}$
 $\varnothing_{\min} = 75 \text{ mm}$

The diameter range always refers to the cutting edge corner, which faces the outer diameter of the component.

Damage caused when the 1st cut is not within the \varnothing_{\min} - \varnothing_{\max} range.

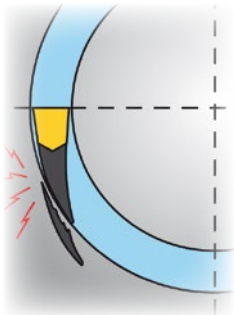

Shows the damage caused when the 1st cut is positioned within a smaller dimension than \varnothing_{\min} . **The outer face** of the cartridge collides with the component.

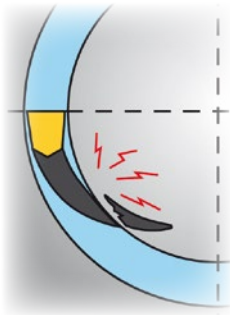

Shows the damage caused when the 1st cut is positioned outside \varnothing_{\max} , to the outer diameter. **The inner face** of the cartridge collides with the component.

Find out the RIGHT cutting speed: Chips must come out SMOOTHLY and may be slightly blue! **i**

Advantages of GripLock threading inserts

- ✓ Inserts fit into many already available tool holders and boring bars.
- ✓ Precision ground inserts.
- ✓ Wide chip-flow clearances.
- ✓ No spare parts.
- ✓ Easy cutting owing to ground clearance angles.
- ✓ Price per cutting edge is comparable to inserts with 3 cutting edges.
- ✓ No shims necessary.

Basics on threading

Overrun dimensions for GripLock threading inserts

System	MC4-external thread full profile				P92-P external and internal thread full and part profile					P92-S external and internal thread full profile		
Pitch	Width of thread relieve cut to DIN76-A	Dimension A	Insert width	Overrun	Dimension A full profile	Dimension A part profile	Insert width	Overrun full profile	Overrun part profile	Dimension A	Insert width	Overrun
0,35	0,7									1,0	2,0	-0,3
0,50	1,1	0,5	2,0	-0,4		2,0	4,0		-0,9	1,0	2,0	0,1
0,70	1,5	0,5	2,0	0,0		2,0	4,0		-0,5	1,0	2,0	0,5
0,75	1,6	0,5	2,0	0,1		2,0	4,0		-0,4	1,0	2,0	0,6
0,80	1,7	0,7	2,0	0,4		2,0	4,0		-0,3	1,0	2,0	0,7
1,00	2,1	0,7	2,0	0,8	0,8	2,0	4,0	-1,1	0,1	1,0	2,0	1,1
1,25	2,7	0,7	2,0	1,4	0,8	2,0	4,0	-0,5	0,7	1,0	2,0	1,7
28W=0,907	2,1	1,0	2,0	1,1		2,0	4,0		0,1	1,0	2,0	1,1
24W=1,05	2,1					2,0	4,0		0,1			
20W=1,27	2,7					2,0	4,0		0,7			
19W=1,337	3,2	1,0	2,0	2,2	0,8	2,0	4,0	0,0	1,2	1,0	2,0	2,2
18W=1,411	3,2					2,0	4,0		1,2			
16W=1,587	3,2					2,0	4,0		1,2			
14W=1,814	3,9	1,3	3,5	1,7	1,3	2,0	4,0	1,2	1,9	1,0	2,0	2,9
12W=2,116	4,5					2,0	4,0	0,5	2,5			
11W=2,309	5,6	1,5	3,5	3,6	1,5	2,0	4,0	3,1	3,6			
10W=2,54	5,6					2,0	4,0		3,6			
1,50	3,2	0,8	3,5	0,5	1,0	2,0	4,0	0,2	1,2	1,0	2,0	2,2
1,75	3,9	0,9	3,5	1,3	1,1	2,0	4,0	1,0	1,9			
2,00	4,5	1,0	3,5	2,0	1,4	2,0	4,0	1,9	2,5			
2,50	5,6	1,3	3,5	3,4	1,5	2,0	4,0	3,1	3,6			
3,00	6,7	1,8	3,5	5	1,8	2,0	4,0	4,5	4,7			

Overrun dimensions marked in RED indicate that a special insert is needed to prevent collision.

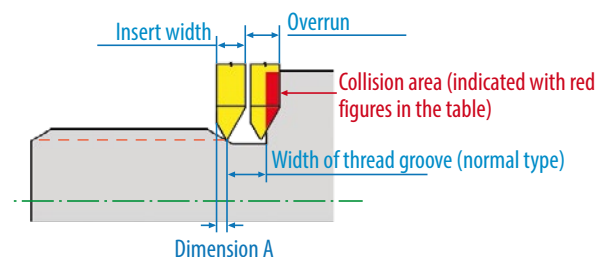

Basics on threading

EXTERNAL THREAD – Threading on main spindle

Threading with: *Main spindle*
Thread: *RH* Holder: *RH*
Rotation: *CCW*

Available systems, tool holders and inserts

M92 Q	P92 P	P92 S

p. 35 p.131-132 p. 146

Working area: *behind the collar*
Threading with: *Main spindle*
Thread: *RH* Holder: *LH*
Rotation: *CW*

Available systems, tool holders and inserts

P92 S

--	--

p. 146

Threading with: *Main spindle*
Thread: *LH* Holder: *LH*
Rotation: *CW*

Available systems, tool holders and inserts

M92 Q	P92 P	P92 S

p. 35 p. 132 p. 146

Threading with: *Main spindle*
Thread: *LH* Holder: *RH*
Rotation: *CCW*

Available systems, tool holders and inserts

P92 S

--	--

p. 146

Working area: *behind the collar*
Threading with: *Main spindle*
Thread: *RH* Holder: *RH overhead*
Rotation: *CCW*

Available systems, tool holders and inserts

P92 S

--	--

p. 146

Threading with: *Main spindle*
Thread: *RH* Holder: *RH overhead*
Rotation: *CCW*

Available systems, tool holders and inserts

M92 Q	P92 P	P92 S

p. 35 p.131-132 p. 146

EXTERNAL THREAD – Threading on tail spindle

Threading with: *Tail spindle*
Thread: *RH* Holder: *RH*
Rotation: *CCW*

Available systems, tool holders and inserts

M92 Q	P92 P	P92 S

p. 35 p.131-132 p. 146

Threading with: *Tail spindle*
Thread: *LH* Holder: *LH*
Rotation: *CW*

Available systems, tool holders and inserts

M92 Q	P92 P	P92 S

p. 35 p.131-132 p. 146

Threading with: *Tail spindle*
Thread: *RH* Holder: *RH overhead*
Rotation: *CCW*

Available systems, tool holders and inserts

M92 Q	P92 P	P92 S

p. 35 p.131-132 p. 146

Threading with: *Tail spindle*
Thread: *LH* Holder: *LH overhead*
Rotation: *CW*











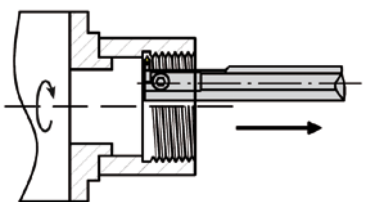



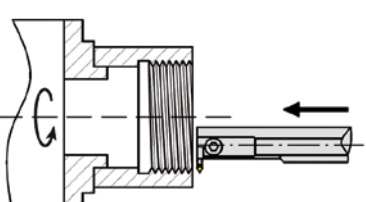







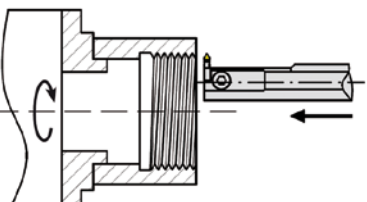







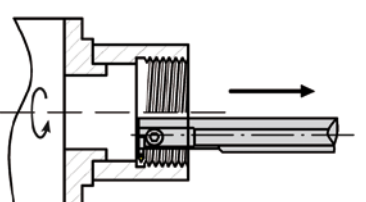







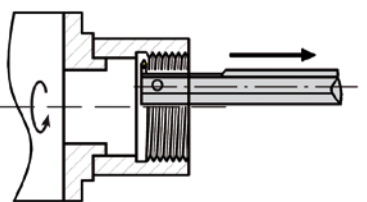



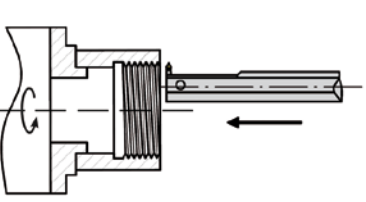

Available systems, tool holders and inserts

M92 Q	P92 P	P92 S

p. 35 p.131-132 p. 146

Basics on threading

INTERNAL THREAD – Threading on main spindle

<p>Threading with: <i>Main spindle</i> Thread: <i>RH</i></p> <p>Boring bar: <i>LH</i> Rotation: <i>CW</i></p>  <p>Available systems, tool holders and inserts</p> <p>P92 S P92 S     p. 147 p. 154</p>	<p>Threading with: <i>Main spindle</i> Thread: <i>RH</i></p> <p>Boring bar: <i>RH</i> Rotation: <i>CCW</i></p>  <p>Available systems, tool holders and inserts</p> <p>P92 P P92 P K P92 S P92 S         p.131-132 p. 139 p. 147 p. 154</p>
<p>Threading with: <i>Main spindle</i> Thread: <i>LH</i></p> <p>Boring bar: <i>LH</i> Rotation: <i>CW</i></p>  <p>Available systems, tool holders and inserts</p> <p>P92 P P92 P K P92 S P92 S         p.131-132 p. 139 p. 147 p. 154</p>	<p>Threading with: <i>Main spindle</i> Thread: <i>LH</i></p> <p>Boring bar: <i>RH</i> Rotation: <i>CCW</i></p>  <p>Available systems, tool holders and inserts</p> <p>P92 P P92 P K P92 S P92 S         p.131-132 p. 139 p. 147 p. 154</p>
<p>Threading with: <i>Main spindle</i> Thread: <i>LH</i></p> <p>Boring bar: <i>RH overhead</i> Rotation: <i>CCW</i></p>  <p>Available systems, tool holders and inserts</p> <p>P92 P P92 P K P92 S P92 S         p.131-132 p. 139 p. 147 p. 154</p>	<p>Threading with: <i>Main spindle</i> Thread: <i>RH</i></p> <p>Boring bar: <i>RH overhead</i> Rotation: <i>CCW</i></p>  <p>Available systems, tool holders and inserts</p> <p>P92 P P92 P K P92 S P92 S         p.131-132 p. 139 p. 147 p. 154</p>

RH and LH threads

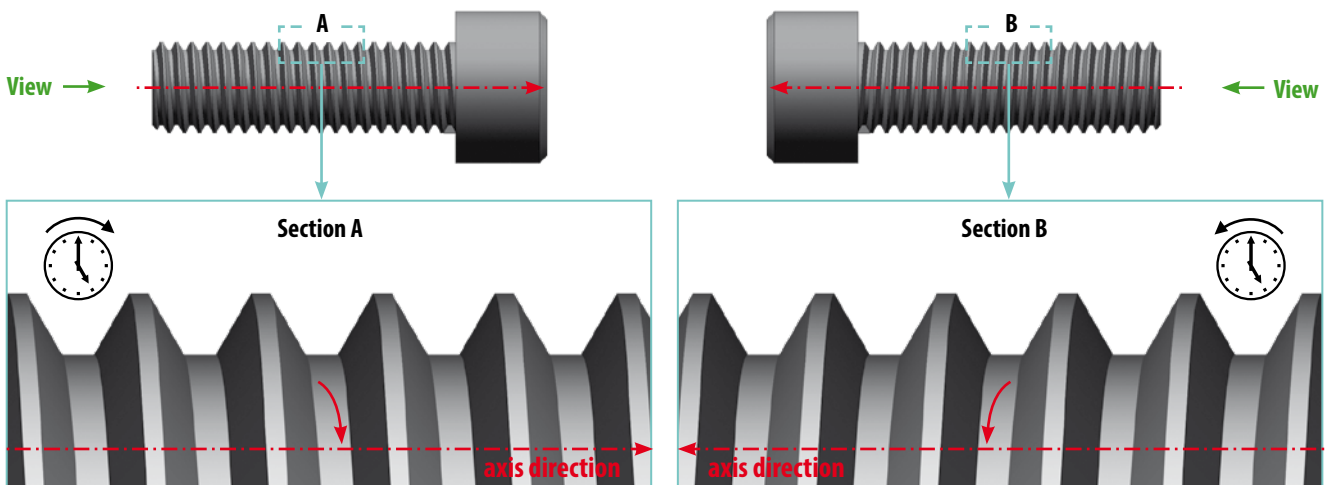

RH thread View in axis direction: Tooth profile winds in clockwise (CW) direction.

LH thread View in axis direction: Tooth profile winds in counter clockwise (CCW) direction.

Basics on threading



Definitions

External thread

Section B: Line parallel to the peak run (S2), Line vertical to the cylinder axis (S1), Thread tip, Thread base, Cylinder axis, $S2$, $S1$, Steigungswinkel.

Section A: Pitch, Flank angle.





Fitting inserts (external thread)

		
p. 35	p. 131-132	p. 146-147

Internal thread

Core - Ø, Flank - Ø, Outside - Ø.

Fitting inserts (internal thread)

			
p. 131-132	p. 139	p. 146-147	p. 154

External thread:

Thread on the outside of a cylinder.

Internal thread:

A thread machined in the surface of a hollow shaft of cylinder.

Outside - Ø (Nominal - Ø):

Diameter of the imaginary cylinder, which touches the thread tips.

Core - Ø:

Diameter of an imaginary cylinder whose surface line touches the thread of the external thread or the thread tips of the internal thread.

Flank - Ø:

The diameter at which the width of the thread tooth equals the width of the spacing between two flanks.

Pitch:

Distance between two threads.

Pitch angle:

Angle between a line vertical to the cylinder axis (S1) and a line parallel with the peak run (S2).

Basics on threading

Thread profiles

Part profile

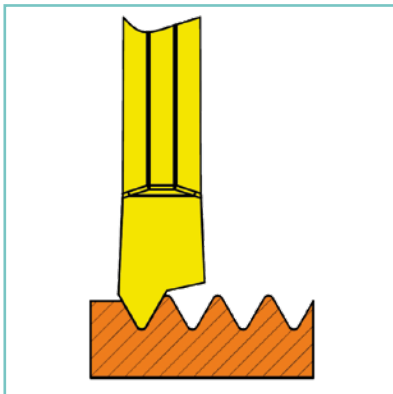

The part profile insert does not finish the outside diameter of external threads or the inside diameter of internal threads.

Full profile

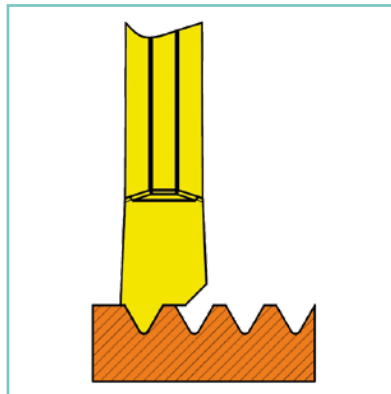



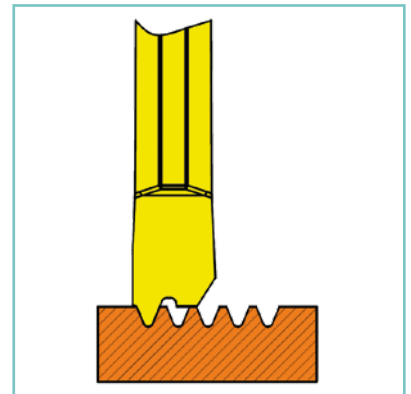

The full profile insert finishes the thread completely. For each pitch and thread type a different insert is necessary

Full profile for small pitches

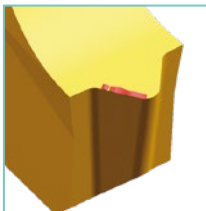

A minor cutting edge finishes the thread.

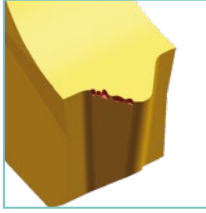
Wear marks and tips to solve them

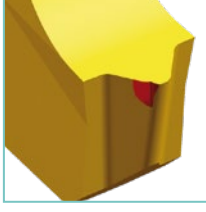
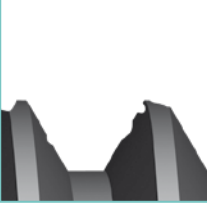
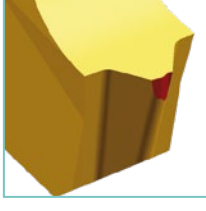
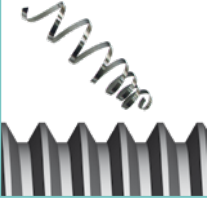
 <p>Built up edge</p> <ul style="list-style-type: none"> • increase speed step by step 	 <p>Plastic deformation</p> <ul style="list-style-type: none"> • reduce speed • increase amount of cuts • increase cooling • check diameter of component. This diameter may be 1.14 mm bigger than the thread diameter. No more!
 <p>Splintering</p> <ul style="list-style-type: none"> • check speed. Is it appropriate? • increase stability of tooling (Least possible extension? Strongest possible tool holder?) • change to modified flank feed • take a tougher grade 	 <p>Vibration</p> <ul style="list-style-type: none"> • alter speed until vibrations cease • check stability of tooling (Least possible extension? Strongest possible tool holder?) • check center height • check diameter of component
 <p>Front clearance wear</p> <ul style="list-style-type: none"> • reduce speed • increase feed • change to modified flank feed • take a more wear resistant grade 	 <p>Poor thread surface</p> <ul style="list-style-type: none"> • increase speed step by step • change to modified flank feed or to radial feed if possible • take a more wear resistant grade
 <p>Fractured edge</p> <ul style="list-style-type: none"> • increase amount of cuts • increase stability of tooling (Least possible extension? Strongest possible tool holder?) • change to modified flank feed • take a tougher grade • check center height 	 <p>Poor chip control</p> <ul style="list-style-type: none"> • reduce amount of cuts • change to modified flank feed • increase speed step by step • increase cooling flow

Basics on threading

Feed methods

Feed method	Machine tools	Advised
<p>Modified flank feed</p>	CNC	<p>1 st choice for CNC machine tools. Good results provided feed direction differs 3° - 5° from the thread flank.</p> <p>This method achieves:</p> <ul style="list-style-type: none"> • Good chip control • Good thread surface • Good tool life
<p>Two-way flank feed</p>	CNC	<p>1 st choice on large thread profiles.</p> <p>This method achieves:</p> <ul style="list-style-type: none"> • Good tool life • Even flank wear
<p>Flank feed</p>	CNC and conventional machine tools	<p>Recommended provided the modified flank feed method can't be applied.</p> <p>This method achieves:</p> <ul style="list-style-type: none"> • Good chip control • Good heat conveyance
<p>Radial feed</p>	conventional machine tools	Multi edge inserts require radial feed

Amount of cuts

To machine the full depth of the thread several different cuts are necessary.

The chip volume increases steadily the more the cutting edge arrives at the bottom of the thread. For this reason the depth of each cut must be reduced constantly, otherwise the edge may fracture quickly.

In any case it is recommended to keep a check on the cutting edge at the beginning of the thread machining:

- Built-up edge will occur, if the speed is too low.
- Plastic deformation will occur, if the speed is too high.
- Fractured edge will occur, if the amount of cuts and the cut setting are insufficient and not fit for the job.

The amount of cuts, the setting accuracy of cuts, the components hardness, respectively toughness and the way cooling or lubrication is applied, strongly influences the quality of the thread.

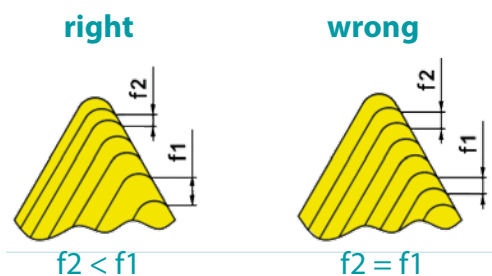

Basics on threading

Number of cuts

Pitch in mm	0.50	0.75	1.00	1.25	1.50	1.75	2.00	2.50	3.00	3.50	4.00	4.50	5.00	5.50	6.00	8.00
Threads per inch	48	32	24	20	16	14	12	10	8	7	6	5.5	5	4.5	4	3
Amount of cuts	4-6	4-7	4-8	5-9	6-10	7-12	7-12	8-14	9-16	10-18	11-18	11-19	12-20	12-20	12-20	15-24

Recommended threading speeds

			PM NANOSPEED	
Material to be machined			HB (Härte Brinell)	Vc in m/min
P	None alloy steel	Carbon steel	125	120 - 180
	Low alloy steel	none hardened	180	85 - 140
		hardened	275	60 - 130
		hardened	350	60 - 130
		annealed	200	70 - 100
	High alloy steel	hardened	325	50 - 100
		low alloy	200	60 - 140
	Cast steel	high alloy	225	60 - 120
Stainless steel ferritic		none hardened	200	70 - 130
	hardened	330	60 - 100	
	Stainless steel austenitic	austenitic	180	90 - 140
		austenitic	200	40 - 100
Stainless cast steel		200	90 - 110	
	hardened	330	65 - 110	
K	Malleable cast iron	ferritic	130	70 - 160
		pearlitic	230	60 - 140
	Grey cast iron	low tensile strength	180	70 - 130
		high tensile strength	260	50 - 115
	Cast iron, nodular graphit	ferritic	160	125 - 160
		pearlitic	260	80 - 120
N	Aluminium materials	none hardened	60	100 - 365
		aged	100	80 - 180
	Aluminium alloys	cast	75	200 - 450
		aged cast	90	200 - 280
	Aluminium materials	cast Si 13 - 22 %	130	60 - 160
	Brass, copper alloy		100	80 - 190
Bronze		100	80 - 190	
S	Heat resisting materials	annealed	200	40 - 60
		aged	280	35 - 50
	Titanium alloys	clean	400 RM	140 - 180
		Alloys Alpha, Beta	1050 RM	50 - 70
H	Hardened steel	hardened and tempered	58 Hrc	45 - 55

Tool holder damages: cause, effect and solution

Cause			
Key and pipe prolongation	Key and forcing with hammer		
			
Effect			
Screw fracturing	Countersink fracturing	Cracking	Hexagonal screw wear
			
Solution			
Handforce	Perfect: with the correct torque	Torque key	
	Only with a torque key, correct screw forces can be applied. To apply correct torques by hand force, requires a lot of experience.		



Recommended torques on page 224.





Save yourself a lot of trouble and energy by using our high quality torque keys.



Technical section GLRM MULTICUT circular milling

Recommendations

type of milling tool	insert type	feed per tooth f_z in [mm]			Thickness of chip [mm] h_m		
		min	-	max	min	-	max
	OFQ16L...P...S	0,04	-	0,22	0,02	-	0,07
	OFQ16L...P...M	0,11	-	0,20	0,06	-	0,14

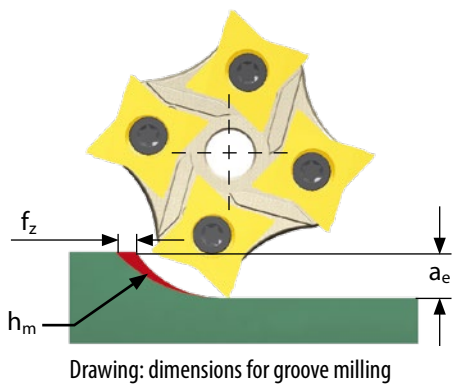

Calculation

average chip thickness	feed per tooth
$h_m = f_z \cdot \sqrt{\frac{a_e}{D}} \text{ [mm]}$	$f_z = h_m \cdot \sqrt{\frac{D}{a_e}} \text{ [mm]}$

recommended values for the chip thickness:

steel: 0,06 mm
grey cast iron: 0,08 mm

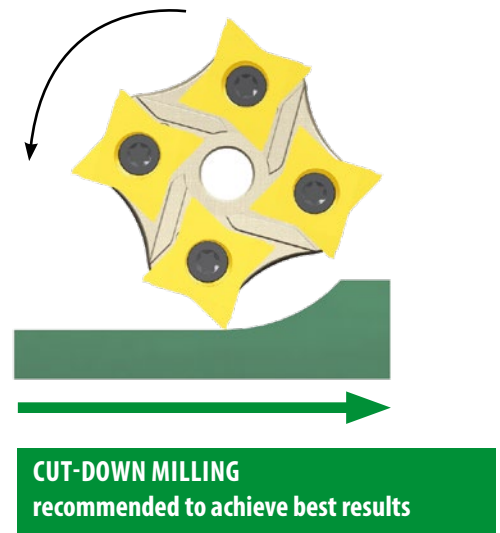
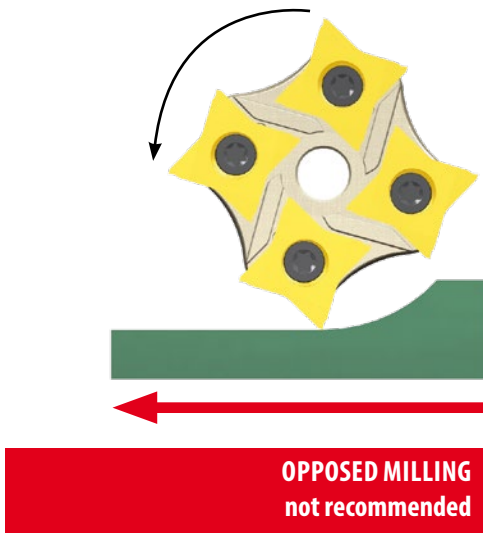



Formeln

Cutting speed	Feed per tooth
$V_c = \frac{D \cdot \pi \cdot n}{1000} \text{ [m/min]}$	$f_z = \frac{V_f}{n \cdot z} \text{ [mm]}$
Revolution	Feed speed
$n = \frac{V_c \cdot 1000}{D \cdot \pi} \text{ [min}^{-1}\text{]}$	$V_f = f_z \cdot z \cdot n \text{ [mm/min]}$

caption

V_c = Cutting speed
 f_z = Feed per tooth
 n = Revolution
 V_f = Feed speed
 h_m = Average chip thickness
 a_e = Cutting depth
 D = Tool diameter
 z = Amount of cutting edges in action
 π = Basic circle dimension = 3,14

Material Comparison Table

Material group	Material No.	Germany DIN No. 	Italy UNI 	Japan JIS 
Steel, free cutting steel				
P	1,0036	USt37-3	FE37BFU	
	1,0050	St50-2	FE50	SM50YA
	1,0060	St60-2	FE60-2	SM570
	1,0070	St70-2	FE70-2	
	1,0332	St14		
	1,0401	C15	C15C16	S15C
	1,0402	C22	C20C21	S20C; S22C
	1,0715	95Mn28	CF95Mn28	SUM22
	1,0501	C35	C35	S35C
	1,0503	C45	C45	S45C
	1,0535	C55	C55	S55C
	1,0601	C60	C60	S60C
	1,0718	95MnPb28	CF95MnPb28	SUM22L
	1,0721	10S20		
	1,1158	Ck25	C25	S25C
	1,1121	Ck10		S10C
	1,1141	CK 15	C16	S15C
	1,1183	Cf35	C36	S35C
	1,1191	Ck45	C45	S45C
	1,1203	Ck55	C50	S55C
	1,1213	Cf53	C53	S50C
	1,1221	Ck60	C60	S58C
	1,1203	Ck55	C50	S55C
	1,1221	Ck60	C60	S58C
	1,2311	40CrMnMo7	35CrMo8KU	
	1,3501	100Cr2		
	1,4882	X50CrMnNiNbN219		
	1,5415	15Mo3	16Mo3KW	
	1,5423	16Mo5	16Mo5	SB450M
	1,5710	36NiCr6		SNC236
	1,5736	36NiCr10		SNC631(H)
	1,5755	31NiCr14		SNC836
	1,5864	35NiCr18		
	1,7223	41CrMo4	41CrMo4	SCM440
	1,7225	42CrMo4	42CrMo4	SCM440(H)
	1,7238	49CrMo4		
	1,7242	16CrMo4		
	1,7262	15CrMo5		SCM415(H)
	1,7335	13CrMo4 4	14CrMo45	SPVAF12
	1,7337	16CrMo4 4	A18CrMo45KW	
	1,7361	32CrMo12	32CrMo12	
	1,7362	12CrMo19 5	16CrMo205	
	1,7380	10CrMo9 10		SPVA, SCMV4
	1,7561	42CrV6		
	1,7701	51CrMoV4	51CrMoV4	
1,7715	14MoV6 3			
1,7733	24CrMoV55	21CrMoV511		
1,7755	GS-45CrMoV104			
1,8070	21CrMoV511	35NiCr9		
1,8159	50CrV4	50CrV4/ 51CrV4	SUP10	
1,8509	41CrAlMo7	41CrAlMo7	SACM645	
1,8523	39CrMoV139	36CrMoV12		



Material Comparison Table

Material group	Material No.	Germany DIN No.		Italy UNI		Japan JIS	
Alloy steel and tool steel							
P	1,2067	100Cr6				SUJ2	
	1,2210	115CrV3		107CrV3KU			
	1,2241	51CrV4					
	1,2419	105WCr6		10WCr6/107WCr5KU		SKS31	
	1,2542	45WCrV7		45WCrV8KU			
	1,2550	60WCrV7		58WCr9KU			
	1,2713	55NiCrMoV6				SKH1/SKT4	
	1,2721	50NiCr13					
	1,2762	75CrMoNiW67					
	1,2842	90MnCrV8		88MnV8KU			
	1,3505	100Cr6		100Cr6			
	1,5622	14Ni6		14Ni6		SUJ2	
	1,5752	14NiCr10/14NiCr14		16NiCr11		SNC415(H)	
	1,6511	36CrNiMo4		38NiCrMo4(KB)		SNC815(H)	
	1,6523	21NiCrMo2		20NiCrMo2		SNCM447	
	1,6546	40NiCrMo22		40NiCrMo2(KB)		SNCM220(H)	
	1,6582	35CrNiMo6		35NiCrMo6(KB)		SNCM240	
	1,6587	17CrNiMo6				SNCM447	
	1,6657	14NiCrMo34		15NiCrMo13			
	1,7033	34Cr4					
	1,7035	41Cr4		41Cr4		SCR430(H)	
	1,7045	42Cr4				SCR440(H)	
	1,7131	16MnCr5		16MnCr5		SCR415	
1,7176	55Cr3				SUP9(A)		
1,7218	25CrMo4		25CrMo4(KB)		SM420/SCM430		
1,7220	34CrMo4		35CrMo4		SCM432/SCCRM3		
High alloy steel and high alloy tool steel							
P	1,2343	X38CrMoV51		X37CrMoV51KYU		SKD6	
	1,2344	X40CrMoV51		X40CrMoV511KU		SKD61	
	1,2379	X155CrVMo121		X155CrVMo12 1KU		SKD11	
	1,2436	X210CrW12		X215CrW121KU		SKD2	
	1,2581	X30WCrV93		X30WCrV93KU		SKD5	
	1,2601	X165CrMoV12		X165CrMoW12KU			
	1,2606	X37CrMoW 51		X35CrMoW05KU		SKD62	
	1,3202	S12-1-4-5		HS12-1-5-5			
	1,3207	S10-4-3-10		HS10-4-3-10		SKH57	
	1,3243	S6-5-2-5		HS6-5-2-5		SLKH55	
	1,3246	S7-4-2-5		HS7-4-2-5			
	1,3247	S2-10-1-8		HS2-9-1-8		SKH51	
	1,3249	S2-9-2-8					
	1,3343	S6-5-2		HS6-5-2-5		SKH9; SKH51	
	1,5662	X8Ni9		X10Ni9		SL9N60(53)	
	1,5680	12Ni19					

Material Comparison Table

Material group	Material No.	Germany DIN No.		Italy UNI		Japan JIS	
Stainless steel							
M	1,4000	X6Cr13		X6Cr3		SUS403	
	1,4001	X6Cr14				4105, 429	
	1,4002	X6CrAl13		X6CrAl13		SUS405	
	1,4006	(G-)X10Cr13		X12Cr13		SUS410	
	1,4016	X8Cr17		X8Cr17		SUS430	
	1,4021	X20Cr13		X20Cr13		SUS420/1	
	1,4027	G-X20Cr14				SCS2	
	1,4034	X46Cr13		X40Cr14			
	1,4057	X20CrNi17		X16CrNi16		SUS431	
	1,4086	G-X120Cr29					
	1,4104	X12CrMoS17		X10CrS17		SUS430F	
	1,4113	X6CrMo17		X8CrMo17		SUS434	
	1,4125	X105CrMo17		X105CrMo17		SUS440C	
	1,4340	G-X40CrNi274					
	1,4417	X2CrNiMoSi195					
	1,4720	X20CrMo13					
	1,4724	X10CrA113		X10CrA112		SUS405	
1,4742	X10CrA118		X8Cr17		SUS430		
1,4762	X10CrA124		X16Cr26		SUH446		
Austenitic stainless steel							
M	1,4301	X5CrNi189		X5CrNi1810		SUS304	
	1,4310	X12CrNi177		X2CrNi1807		SUS301	
	1,4311	X2CrNiN1810		X2CrNiN1810		SUS304LN	
	1,4312	G-X10CrNi188					
	1,4350	X5CrNi189		X5CrNi1810			
	1,4362	X2CrNiN234					
	1,4401	X5CrNiMo17 122		X5CrNiMo 17 12		SUS316	
	1,4404	X2CrNiMo1810		X2CrNiMo1712		SUS316	
	1,4410	G-X10CrNiMo189					
	1,4429	X2CrNiMoN17133		X2CrNiMoN1713		SUS316LN	
	1,4435	X2CrNiMo18 143		X2CrNiMo1712		SCS16	
	1,4436	X3CrNiMo17133		X8CrNiMo1713		SUS316	
	1,4438	X2CrNiMo17133		X2CrNiMo1816		SUS317L	
	1,4500	G-X7NiCrMoCuNb2520					
	1,4541	X5CrNiTi18 9		X6CrNiTi18 11		SUS321	
	1,4550	X10CrNiNb		X6CrNiNb18 11		SUS347	
	1,4552	G_X7CrNiNb 189					
	1,4571	X10CrNiMoTi1810		X6CrNiMoTi1712		SUS316Ti	
	1,4583	X10CrNiMoNb1812		X6CrNiMoNb			
	1,4828	X12CrNi2521				SUH309	
1,4850	G-X7CrNiMoCuNb1818		X6CrNiMoTi1712				
1,4845	X12CrNi25 21		X6CrNi25 20		SUH310/SUS310S		
Austenitic / ferritic stainless steel (Duplex)							
M	1,4460	X8CrNiMo275				SUS329J1	
	1,4462	X2CrNiMoN2253					
	1,4821	X15CrNiSi254					
	1,4823	GX40CrNiSi274					

Material Comparison Table



Material group	Material No.	Germany DIN No.		Italy UNI		Japan JIS	
Grey cast iron							
K	0,6010	GG10		G10		FC100	
	0,6015	GG15		G14		FC150	
	0,6020	GG20		G20		FC200	
	0,6025	GG25		G25		FC250	
	0,6030	GG30		G30		FC300	
	0,6035	GG35		G35		FC350	
	0,6040	GG40				FC400	
Nodular cast iron							
K	0,7033	GGG35,3				FDC350	
	0,7040	GGG40		GGG40		FDC400	
	0,7043	GGG40,3				FDC400	
	0,7050	GGG50		GGG50		FDC500	
	0,7060	GGG60		GGG60		FDC600	
	0,7070	GGG70		GGG70		FDC700	
Malleable cast iron							
K	0,8035	GTW-35					
	0,8040	GTW-40		GMB40			
	0,8045	GTW-45		GMB45			
	0,8055	GTW-55					
	0,8065	GTW-65					
	0,8135	GTS-35					
	0,8145	GTS-45					
	0,8155	GTS-55					
	0,8165	GTS-65					
	0,8170	GTS-70					

Material Comparison Table

Material group	Material No.	Germany DIN No.	Germany	Italy UNI	Italy	Japan JIS	Japan
Aluminium alloys							
N	3,0255	Al99.5					
	3,1655	AlCuSiPb					
	3,1754	G-AlCu5Ni1,5		AZ4GU/9051		7050	
	3,2373	G-AlSi9Mg					
	3,2381	G-AlSi10Mg					
	3,2382	GD-AlSi10Mg					
	3,2383	G-AlSi10Mg(Cu)					
	3,2581	G-AlSi12					
	3,2582	GD-AlSi12				A6061	
	3,2583	G-AlSi12(Cu)				ADC12	
	3,3315	AlMg1					
	3,3561	G-AlMg5				AC4A	
	3,5101	G-MgZn4SE1Zr1					
	3,5103	MgSE3Zn2Zr1					
	3,5106	G-MgAg3SE2Zr1					
	3,5812	G-MgAl8Zn1					
	3,5912	G-MgAl9Zn1					
2,1871	G-AlCu4TiMg						
3,2371	G-AlSi7Mg						
Copper alloys							
N	2,1090	G-CuSn7ZnPb					
	2,1096	G-CuSn5ZnPb					
	2,1098	G-CuSn2ZnPb					
	2,1176	G-CuPb10Sn					
	2,1182	G-CuPb15Sn					
	2,0240	CuZn15					
	2,0265	CuZn30					
	2,0321	CuZn37		C2700,C2720			
	2,0592	G-CuZn35Al1					
	2,0596	G-CuZn34Al2					
	2,1188	G-CuPb20Sn					
	2,1292	G-CuCrF35					
	2,1293	CuCrZr					
	2,0966	CuAl10Ni5Fe4					
	2,0975	G-CuAl10Ni					
	2,1050	G-CuSn10					
	2,1052	G-CuSn12					

Material Comparison Table

Material group	Material No.	Germany DIN No. 	Italy UNI 	Japan JIS 
		Super alloys on Fe-basis		US-Trade Mark
S	1,4558	X2NiCrAlTi3220	Incoloy 800	
	1,4562	X1NiCrMoCu32287		
	1,4563	X1NiCrMoCuN31274		
	1,4864	X12NiCrSi		SUH330
	1,4864	X5NiCrSi3616		SUH330
	1,4958	X5NiCrAlTi3120		
	1,4977	X40CoCrNi2020		
		Super alloys on Ni-basis		US-Trade Mark
S	1,4360	NiCu30FE	Monel 400	
	2,4375	NiCu30Al	Monel K-500	
	2,4610	NiMo16Cr16Ti	Hastelloy C-4	
	2,4630	NiCr20Ti	Nimonic 75	
	2,4642	NiCr29Fe	Inconel 690	
	2,4668	NiCr19FeNbMo	Inconle 718	
	2,4669	NiCr15Fe7TiAl	Inconel X-750	
	2,4685	G-NiMo28	Hastelloy B	
	2,4694	NiCr16Fe7TiAl	Inconel 751	
	2,4810	G-NiMo30	Hastelloy C-4	
	2,4856	NiCr22Mo9N	Inconel 625	
	2,4858	NiCr21Mo	Incoloy 825	
		Titanium and Titanium alloys		US-Trade Mark
S	3,7025	Ti 1		
	3,7124	TiCu2		
	3,7195	TiAl3V2.5		
	3,2250	Ti1Pd		
	3,7115	TiAl6Sn2		
	3,7145	TiAl6Sn2Zr4Mo2Si		
	3,7165	TiAl6V4	TiAl6V4	
	3,7175	TiAl6V6Sn2	Ti6V6Al2Sn	
	3,7185	TiAl4Mo4Sn2		

Material group	Material No.	Germany DIN No. 	Italy UNI 	Japan JIS 
Hartguss				
H	0,9620	G-X260NiCr42		
	0,9625	G-X330NiCr42		
	0,9630	G-X300CrNiSi952		
	0,9635	G-X300CrMo153		
Gehärtetes Gusseisen				
H	0,9640	G-X300CrMoNi1521		
	0,9645	G-X260CrMoNi2021		
	0,9650	G-X260Cr27		
	0,9655	G-X300CrMo271		

Product index

A		G	
A BTNN81	GLMCL/R 16ERISO	197
A CTD81	GLMCL/R CC09T3	198
A GTNS81	GLMCL/R CN1204	199
A SCTD82	GLMCL/R DC11T3	198
AW F16	165, 196	GLMCL/R DN1506	199
B		GLMCL/R VC1303	198
BF N/R/L	160	GLMCL/R VC1604	198
BGN /R/L	178	GLMCL/R VN1604	199
BGP N/R/L F	171	GLMCL/R WN0804	199
BTNG69	GLMC R/L F16	195
BTNG Hardlox 284	GLMC R/L F16 HP	196
BTNN GF11075	GLM C R/L M92 Q	193
BTNN Hardlox 285	GLM C R/L M92 Q HP	193
BTNN/R/L74	GLM C R/L P92	194
BTNN/R/L F76	GLM C R/L P92 HP	194
BTNS	143	GLM C R/L P92 P	195
BTNX69	GLM H R/L	189
C		GLM HSKT 0 R/L	191
CLCB R/L	179	GLM HSKT 10 R/L	191
CLCB R/L..X	180	GLM HSKT 45 R/L	191
CLPP R/L	172	GLM HSKT 90 R/L	192
CLPP R/L..X	173	GLM PSC 0 R/L	190
Cooling flow unit	192	GLM PSC 90 R/L	190
CTD ALU Hardlox86	GLRM92 28..SW...53
CTD/R/L-ALU77	GLRM92 52..SW...53
CTD R/L IT78	GLRM92..M...54
CTDS63	GTNS67
D		H	
Torque key and -screwdriver	226	HTNG 2 ER	146
E		HTNG 2 IR	147
Spare parts	224	HTNS Hardlox 2	150
Spare parts for GLM-ISO	225	HTN S/R/L	144
ETNZ64	HTNST	145
F		I	
F 00000...00	205	IFN	161
F16L/R HP	221	IFN ALU	162
F16 PM 0	167	IT N/R/L ALU	178
F16 PM 5	167	IT N/R/L	177
F16 R/L 42	163	ITNS Hardlox 2	150
F16 R/L 42 HP	163	ITN S/R/L	143
F16 R/L 65	164	ITPN	171
F16 R/L 65 HP	165	K	
F16 R/L 2608	165	KCTD	107
F16 R/L 3208	165	KCTD Hardlox 287, 108
F16 R/L HP	164	KCTDS	107
F16T	166	KHTNG IR	154
F16T HP	166	KHTNS	154
F92 SFCCN	206	KHTNS Hardlox	151, 155
		KL 52	183
		KLV	183
		KOTX IR	139
		KOTX R/L	138

Produktindex

KOTX R R/L 138

L

LTNN 80

M

M92 Q 90 FXCBL/R 45
 M92 Q FXCB R/L HP 44, 219
 M92-Q...R/L 43
 M92-Q...X...R/L 45
 MTNS 61
 MTNSG 62
 MTNS Hardlox 2 84
 MTNZ 66

O

OFQ16L-.N/L 29
 OFQ16L..P..M 52
 OFQ16L..P..S 49, 51
 OFQ16L..R..P..S 50
 OFQ16R..ER ISO Hardlox 2 42
 OFQ16 R/L A 50. 33
 OFQ16 R/L...EIR 37
 OFQ16 R/L...ER/EL 35, 36
 OFQ16 R/L-.N. 31
 OFQ16 R/L...N00 Hardlox 2. 39
 OFQ16 R/L...N Hardlox 2 41
 OFQ16 R/L...R...N 34
 OFQ16 R/L..R...N Hardlox 2 40
 OFQ16R-.N/R 30
 OTX4 Deco 130
 OTXC 70
 OTX EIR. 132
 OTX ER 131
 OTX IR. 131
 OTX..R/L 125
 OTX R N. 127
 OTX R N R 127
 OTX R..R/L 126
 OTXS 70

P

P92 2 CXCB R/L 118, 119, 120
 P92 2 CXCRD/LD 113,114
 P92 2 TMS 121
 P92 90 CXCLD. 115
 P92 90 CXCRD 116
 P92 90 UNI. 95
 P92 A CXCB R/L. 96, 97
 P92 A CXCB R/L HP 98
 P92 CGL/R 106
 P92 CG R/L...30C 108
 P92 CL/R HP G1/8 105
 P92 CXCBL/R HP 219, 220
 P92 CXCB R/L 88, 89, 90, 91, 92, 93
 P92 CXCB R/L 20+25 HP 94
 P92 CXCB R/L 30 HP 94

P92..CXCB R/L2608X..R/L 101
 P92..CXCB R/L3208X..R/L 101
 P92..CXCB R/L3208X..R/L HP. 102
 P92 P 45 CG R/L. 137
 P92 P 45 CXCB R/L 137
 P92 P 90 UNI 136
 P92 P CG R/L 135
 P92 P CG R/L 4C 139
 P92 P CXCB R/L. 133
 P92 P CXCB R/L..K4-11 134
 P92 S CG R/L. 153
 P92 S CG R/L...M20C 155
 P92 S CXCBL..11 152
 P92 S CXCB R/L 152
 P92 S CXCB R/L X. 153
 P92 TMS 103
 P92 TMS 52 104
 P92 TMS HP 104
 PPSMS R/L 175
 PPTN R/L 174
 PTNSM 65

R

RTNG 71
 RTNG Hardlox 2 85
 RTNX 71

S

SCTD 79
 SCTD Hardlox 2. 86
 SF N/R/L 162
 SNPN 170
 SNT N/R/L 176
 STD R/L. 129
 STN S/R/L 144
 STNS Hardlox2 150
 STNZ / STNG. 63
 STV R/L. 128

T

Technical Section 229
 TMS 181
 TMSPP 173
 TS 182
 TX 6 227
 TX 25 10 227

V

VTNS 61

X

XTNS 68

Notes

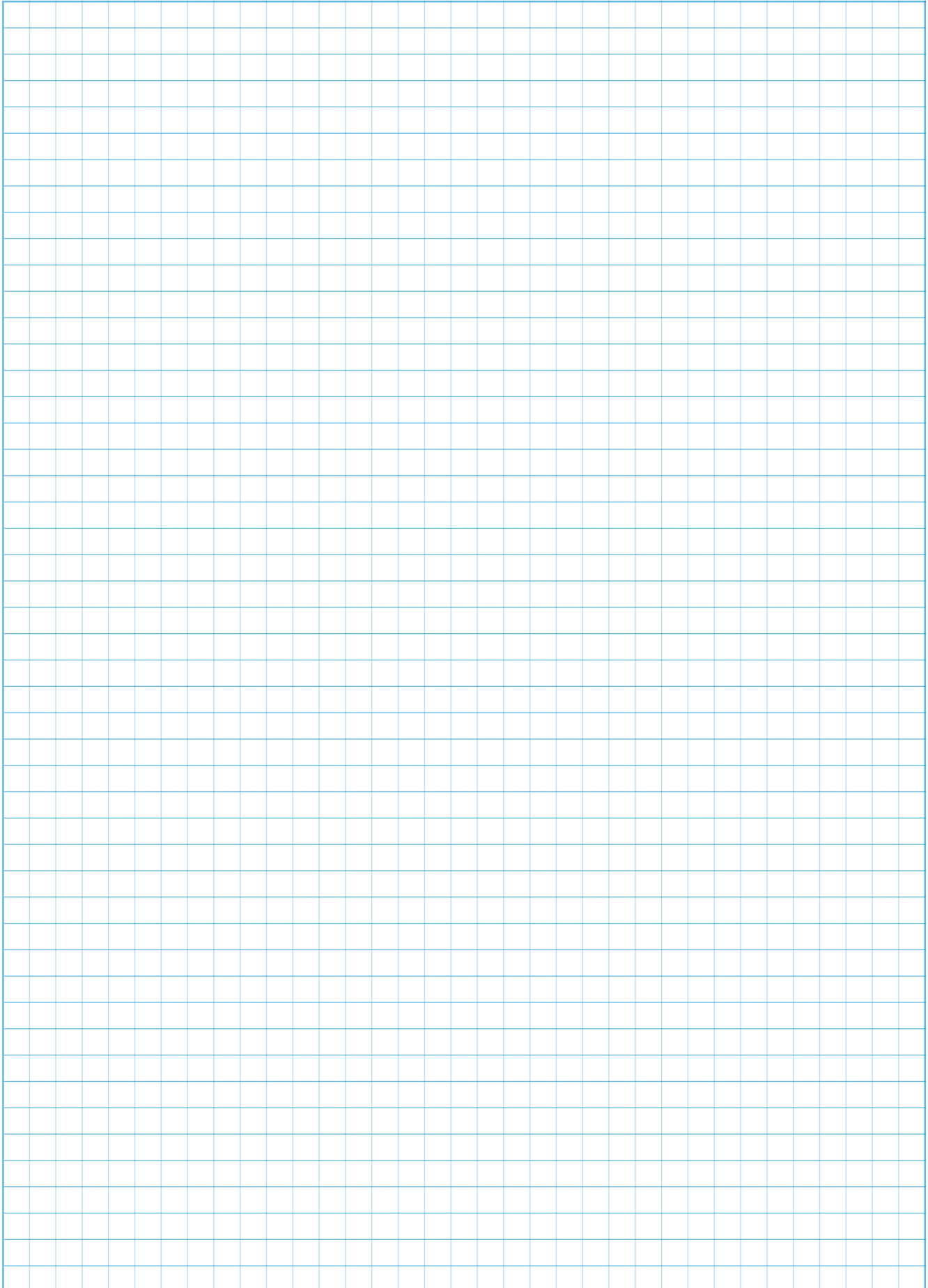

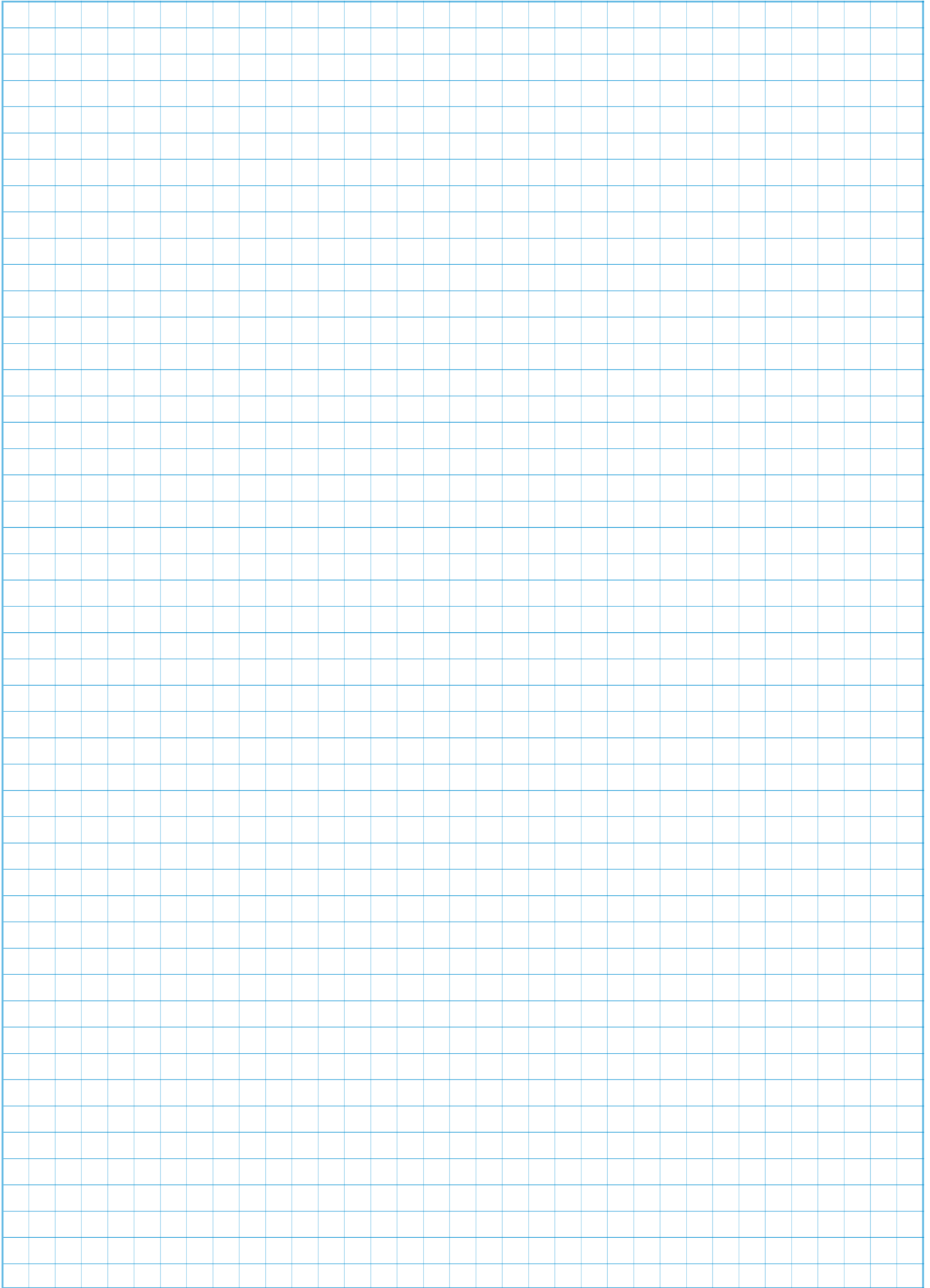

Kemmer Hartmetallwerkzeuge GmbH

Vertrieb & Verwaltung *Sales & Administration*

Im Täle 11 • D-72218 Wildberg
Telefon: +49 (0) 7054 9291-0
Fax: +49 (0) 7054 9291-26
eMail: info@kemmerHMW.de

Produktion & Entwicklung *Production & Development*

Gewerbestr. 11 • D-98544 Zella-Mehlis
Telefon: +49 (0) 3682 8955-0
Fax: +49 (0) 3682 8955-55
www.KemmerHMW.de